



samlexpower®

**Evolution™ Series
Inverter/Charger
Pure Sine Wave**

Models:
EVO-2212
EVO-3012
EVO-2224
EVO-4024

Owner's
Manual

Please read this
manual BEFORE
operating.

Firmware:
Rev 0.77

EVO™ INVERTER/CHARGER MANUAL | Index

SECTION 1.1	
Safety Instructions	3
SECTION 1.2	
Definitions	9
SECTION 1.3	
General Information – Inverter Related	12
SECTION 1.4	
General Information – Battery Related	16
SECTION 2	
Components & Layout	30
SECTION 3	
Installation	34
SECTION 4	
General Description & Principles of Operation	66
SECTION 5	
Battery Charging in Evolution™ Series	81
SECTION 6	
Operation, Protections & Troubleshooting	109
SECTION 7	
Specifications	119
SECTION 8	
Warranty	122
APPENDIX A	
EVO-RC (Optional Remote Control) Owner's Manual	

Disclaimer of Liability

UNLESS SPECIFICALLY AGREED TO IN WRITING, SAMLEX AMERICA INC.:

1. MAKES NO WARRANTY AS TO THE ACCURACY, SUFFICIENCY OR SUITABILITY OF ANY TECHNICAL OR OTHER INFORMATION PROVIDED IN ITS MANUALS OR OTHER DOCUMENTATION.
2. ASSUMES NO RESPONSIBILITY OR LIABILITY FOR LOSSES, DAMAGES, COSTS OR EXPENSES, WHETHER SPECIAL, DIRECT, INDIRECT, CONSEQUENTIAL OR INCIDENTAL, WHICH MIGHT ARISE OUT OF THE USE OF SUCH INFORMATION. THE USE OF ANY SUCH INFORMATION WILL BE ENTIRELY AT THE USERS RISK.

Samlex America reserves the right to revise this document and to periodically make changes to the content hereof without obligation or organization of such revisions or changes.

Copyright Notice/Notice of Copyright

Copyright © 2019 by Samlex America Inc. All rights reserved. Permission to copy, distribute and/or modify this document is prohibited without express written permission by Samlex America Inc.

SECTION 1.1 | Safety Instructions

1.1 IMPORTANT SAFETY INSTRUCTIONS

SAVE THESE INSTRUCTIONS. THIS MANUAL CONTAINS IMPORTANT INSTRUCTIONS FOR MODELS: EVO-2212, EVO-3012, EVO-2224 AND EVO-4024 THAT SHALL BE FOLLOWED DURING INSTALLATION & MAINTENANCE OF THE INVERTER/CHARGER.

THE FOLLOWING SYMBOLS WILL BE USED IN THIS MANUAL TO HIGHLIGHT SAFETY AND IMPORTANT INFORMATION:



WARNING!

Indicates possibility of physical harm to the user in case of non-compliance.



CAUTION!

Indicates possibility of damage to the equipment in case of non-compliance.



INFO

Indicates useful supplemental information.



MISE EN GARDE!

Il y a une possibilité de faire du mal physique à l'utilisateur si les consignes de sécurités sont pas suivies.



ATTENTION!

Il y a une risque de faire des dégâts à l'équipement si l'utilisateur ne suit pas les instructions.

Please read these instructions **BEFORE** installing or operating the unit to prevent personal injury or damage to the unit.



WARNING! /



CAUTION!

1. **WARNING!** To reduce risk of explosion, do not install in machinery space or in area in which ignition-protected equipment is required to be used.
2. **CAUTION!** (a) To prevent damage due to excessive vibration / shock, use on marine vessels with lengths more than 65 ft. (19.8M). (b) This unit is NOT designed for weather-deck installation. To reduce risk of electrical shock, do not expose to rain or spray.
- 3.1 **CAUTION!** EVO™ Inverter/Charger with fully automatic charging circuit charges properly rated 12V / 24V Lead Acid, Nickel Zinc (Ni-Zn) and Lithium Ion Batteries. When EVO™ Inverter/Charger is in Charge Mode, Green LED marked "ON" will be blinking.
- 3.2 **WARNING! Lithium Ion Battery Hazard.** Option is available to use 12V / 24V nominal Lithium Ion batteries. The user/installer should ensure that charging voltages, currents and profiles are programmed appropriately to meet all operating and safety requirements of the battery being used. Make sure that the Lithium Ion Battery includes Battery Management System (BMS) with built-in safety protocols. Follow the instructions specified by the Lithium Ion Battery manufacturer. When the EVO™ Inverter/Charger is in Charge Mode, Green LED marked "ON" will be blinking.

SECTION 1.1 | Safety Instructions

4. **CAUTION!** For indoors use only.
5. **WARNING!** Hot Surfaces! To prevent burns, do not touch!
6. **CAUTION!** The AC input / output wiring terminals are intended for field connection using Copper conductors that are to be sized based on 75°C. See Table 1.1.1 for sizing of conductors for AC INPUT circuits and Table 1.1.2 for sizing of conductors for AC OUTPUT circuits.
7. **WARNING!** Over current protection (AC Breakers) for the AC input / output circuits has NOT been provided and has to be provided by the installer / user. See guidelines at Table 1.1.1 for sizing of breakers for AC INPUT circuits and Table 1.1.2 for sizing of breakers for AC OUTPUT circuits. National and Local Electrical Codes will supersede these guidelines.
8. **CAUTION!** The battery terminals are intended for field connection of battery side cables using Copper conductors that are sized based on 90°C. See Table 1.1.3 for recommended sizes of battery side cables for installation in free air and conduit respectively.
9. **WARNING!** Over current protection (fuse) for battery and External Charger circuits has NOT been provided and has to be provided by the installer / user. See guidelines at Table 1.1.3 for recommended sizes for installation in free air and conduit respectively. National and Local Electrical Codes will supersede these guidelines.
10. Tightening torques to be applied to the wiring terminals are given in Table 1.1.4.
11. This unit has been provided with integral protections against overloads.
12. **WARNING!** To reduce risk of electric shock and fire:
 - Installation should be carried out by certified installer and as per Local and National Electrical Codes.
 - Do not connect to circuit operating at more than 150 Volts to Ground.
 - Do not connect to AC Load Center (Circuit Breaker Panel) having Multi-wire Branch Circuits connected .
 - Both AC and DC voltage sources are terminated inside this equipment. Each circuit must be individually disconnected before servicing.
 - Do not remove cover. No user serviceable part inside. Refer servicing to qualified servicing personnel.
 - Do not mount in zero clearance compartment.
 - Do not cover or obstruct ventilation openings.
 - Fuse(s) should be replaced with the same type and rating as of the original installed fuse(s).
13. **WARNING!** Risk of electric shock. Use only those GFCIs that are listed at Table 1.1.5. Other types may fail to operate properly when connected to this unit.
14. **GROUNDING:** The Grounding symbol shown below is used for identifying only the field wiring equipment-grounding terminal. However, this symbol is usable with the circle omitted for identifying various points within the unit that are bonded to Ground.



Grounding Symbol / *Défaut à la terre*

15. **WARNING!** Precautions When Working With Batteries.

Lead Acid Batteries

- Batteries contain very corrosive diluted Sulphuric Acid as electrolyte. Precautions should be taken to prevent contact with skin, eyes or clothing. Wear eye protection.
- Batteries generate Hydrogen and Oxygen during charging resulting in evolution of explosive gas mixture. Care should be taken to ventilate the battery area and follow the battery manufacturer's recommendations.

SECTION 1.1 | Safety Instructions

- Never smoke or allow a spark or flame near the batteries.
- Use caution to reduce the risk of dropping a metal tool on the battery. It could spark or short circuit the battery or other electrical parts and could cause an explosion. Always use insulated tools.
- Remove metal items like rings, bracelets and watches when working with batteries. Batteries can produce a short circuit current high enough to weld a ring or the like to metal and thus cause a severe burn.
- If you need to remove a battery, always remove the Ground terminal from the battery first. Make sure that all the accessories are off so that you do not cause a spark.

Lithium Ion Batteries

- Ensure that the battery includes Battery Management System (BMS) with built-in safety protocol.
- Ensure that voltage, current and charging profile settings of the charger are correct
- Ensure that the Battery Management System (BMS) of the battery is able to provide contact closure signal to the EVO™ Inverter/Charger under conditions of (i) over voltage / over heating (to stop charging) and (ii) deep discharge (to stop inverting) [Refer to Section 5.11.2].



MISE EN GARDE! /  **ATTENTION!**

1. **MISE EN GARDE!** Pour réduire les risques d'explosion, ne pas installer dans les locaux de machines ou dans la zone où l'équipement protégé contre les incendies doit être utilisé.
2. **ATTENTION!** Cet appareil est conçu pour une installation PAS Météo-pont. Pour réduire les risques de choc électrique, ne pas exposer à la pluie ou à la neige.
- 3.1 **ATTENTION!** L'onduleur / chargeur EVO™ avec circuit de charge entièrement automatique charge des batteries au plomb 12V / 24V correctement dimensionnées. Lorsque l'onduleur / chargeur EVO™ est en mode de charge, la DEL verte marquée «ON» clignote.
- 3.2 **ATTENTION! Danger pour la batterie lithium-ion.** L'option est disponible pour utiliser des batteries au lithium de 12V / 24V. L'utilisateur / installateur doit s'assurer que les tensions de charge, les courants et les profils sont programmés de façon appropriée pour répondre à toutes les exigences de fonctionnement et de sécurité de la batterie utilisée. L'onduleur / chargeur EVO™ est alors en mode de charge, le voyant vert marqué "ON" clignote.
4. **ATTENTION!** Pour éviter les dommages dus à des vibrations excessives / choc, ne pas utiliser sur les navires plus petits avec des longueurs de moins de 65 pi. (19,8).
5. **MISE EN GARDE!** Surfaces chaudes! Pour éviter les brûlures, ne touchez pas.
6. **ATTENTION!** Les bornes de câblage entrée / sortie CA sont prévus pour un raccordement sur le terrain avec des conducteurs de cuivre qui doivent être dimensionnés en fonction de 75 ° C. Voir le tableau 1.1.2 et pour le dimensionnement des conducteurs pour les circuits d'entrée CA et le tableau 1.2 pour le dimensionnement des conducteurs pour les circuits de sortie AC.
7. **MISE EN GARDE!** Protection contre les surintensités (AC Les disjoncteurs) pour l'AC circuits d'entrée / de sortie n'a pas été fournie pour EVO-1212F-HW / 1224F-HW et doit être fournie par l'installateur/ utilisateur. Voir les lignes directrices à tableau 1.1.1 pour le dimensionnement des disjoncteurs pour les circuits d'entrée CA et le tableau 1.1.2 pour le dimensionnement des disjoncteurs pour les circuits de sortie AC. Codes électriques nationaux et locaux remplaceront ces lignes directrices.

SECTION 1.1 | Safety Instructions

8. **ATTENTION!** Les bornes de la batterie sont destinés pour le champ Connexion à l'aide de conducteurs de cuivre qui sont dimensionnés en fonction de 90°C. Voir les tableau 1.1.3 pour les tailles recommandées pour l'installation à l'air libre et conduit respectivement.
9. **MISE EN GARDE!** Protection contre les surintensités (fusible) pour la batterie et les circuits chargeur externe n'a pas été fournis et a fourni à l'installateur / utilisateur. Voir les lignes directrices à tableau 1.1.3 pour les tailles recommandées pour l'installation à l'air libre et conduit respectivement. Codes électriques nationaux et locaux remplaceront ces lignes directrices.
10. Couples de serrage pour être appliqués sur les bornes de câblage sont donnés dans le tableau 1.1.4.
11. Cet appareil a été fourni avec des protections intégrées contre les surcharges.
12. **MISE EN GARDE!** Pour réduire les risques de choc électrique et d'incendie:
 - L'installation doit être effectuée par un installateur certifié et selon les codes électriques locaux et nationaux
 - Ne pas se connecter au circuit fonctionnant à plus de 150 volts à la terre
 - Ne pas se connecter au Centre de charge AC (Circuit de panneau de disjoncteurs) ayant Direction Multi-fil circuits reliés
 - Les deux sources de tension AC et DC sont terminées à l'intérieur de cet équipement. Chaque circuit doit être déconnecté individuellement avant l'entretien
 - Ne pas retirer le couvercle. Aucune partie réparable par l'utilisateur à l'intérieur. Faites appel à un installateur qualifié
 - Ne pas monter dans zéro compartiment de jeu
 - Ne pas couvrir ou obstruer les ouvertures de ventilation.
 - Fusible (s) doit être remplacé par le même type de fusible du fusible installé d'origine (s)
13. **MISE EN GARDE!** Risque de choc électrique. N'utilisez que les GFCIs qui sont indiqués au tableau 1.1.5. D'autres types peuvent ne pas fonctionner correctement lorsqu'il est connecté à cet appareil.
14. **MISE À LA TERRE:** Le symbole de mise à la terre ci-dessous est utilisé pour identifier uniquement l'équipement terminal de terre-câblage. Toutefois, ce symbole est utilisable avec le cercle omis pour identifier divers points de l'unité qui sont liés à la masse.

 Grounding Symbol / Défaut à la terre

15. **MISE EN GARDE!** Précautions lorsque vous travaillez avec des piles.

Batteries au plomb

- Les batteries contiennent de très corrosif de l'acide sulfurique dilué comme électrolyte. Des précautions doivent être prises pour éviter tout contact avec la peau, les yeux ou les vêtements. Porter des lunettes de protection.
- Générer de l'hydrogène des batteries et de l'oxygène au cours de la charge résultant de l'évolution du mélange de gaz explosifs. Il faut prendre soin de bien aérer la zone de la batterie et de suivre les recommandations du fabricant.
- Ne jamais fumer ou permettre qu'une étincelle ou une flamme à proximité des batteries.
- Procédez avec précaution pour réduire le risque de chute d'un outil métallique sur la batterie. Il pourrait déclencher ou court-circuit de la batterie ou d'autres pièces électriques et pourraient provoquer une explosion. Toujours utiliser des outils isolés.

SECTION 1.1 | Safety Instructions

- Retirer les objets métalliques tels que bagues, bracelets et montres lors de travaux avec des batteries. Les batteries peuvent produire un courant de court-circuit suffisamment haut pour souder un anneau ou similaires à metal et donc provoquer des brûlures sévères.
- Si vous avez besoin de retirer la batterie, retirez toujours la borne de masse de la batterie en premier. S'assurer que tous les accessoires sont off afin de ne pas provoquer une étincelle.

Les batteries au lithium-ion

- S'assurer que la batterie comprend Battery Management System (BMS) avec protocole de sécurité intégré.
- S'assurer que la tension, le courant et les paramètres de profil de charge le chargeur sont corrects
- S'assurer que le système de gestion de la batterie (BMS) de la batterie est en mesure de fournir de la fermeture du contact signal à l'onduleur/chargeur EVO™ dans des conditions de (i) surtension / plus de chauffage (d'arrêter le chargement) et (ii) une décharge profonde (pour arrêter l'inversion) [Se reporter à la Section 5.11.2].

TABLE 1.1.1 SIZING OF AC INPUT WIRING AND BREAKERS (Refer to Section 3.8.1, Table 3.2 for more details)

Model No. (Rated Output Power in Inverter Mode) (Column 1)	Rated AC Pass Through Current (Column 2)	Rated AC Side Charging Current (Column 3)	Rated AC Input Current (Columns 2+ and 3) (Column 4)	NEC Ampacity = 125% of Column 4 (Column 5)	Conductor Size Based on NEC Ampacity at Column 5 (Column 6)	Size of Breaker Based on Column 4 (Column 7)
EVO-2212 (2200VA)	18A	15A	33A	41.25A	AWG# 8	45A
EVO-2224 (2200VA)	18A	19A	37A	46.25A	AWG# 8	50A
EVO-3012 (3000VA)	25A	20A	45A	56.25A	AWG# 6	60A
EVO-4024 (4000VA)	33A	30A	63A	78.75A	AWG# 4 or 2x AWG# 6	80A

Table 1.1.2 AC OUTPUT WIRING AND BREAKERS (Refer to Section 3.9.1, Table 3.3 for more details)

Model No. (Rated Power in Inverter Mode) (Column 1)	Rated AC Output Current in Inverter Mode (Column 2)	NEC Ampacity = 125% of Column 2 (Column 3)	Conductor Size based on NEC Ampacity at Column 3 and 75°C Copper Conductor in Conduit (Column 4)	Breaker Size (Based on NEC Ampacity at Column 3) (Column 5)
EVO-2212 (2200VA)	18A	22.5A	AWG# 10	25A
EVO-2224 (2200VA)	18A	22.5A	AWG# 10	25A
EVO-3012 (3000VA)	25A	31.25A	AWG# 8	35A
EVO-4024 (4000VA)	33A	41.25A	AWG# 8	45A

SECTION 1.1 | Safety Instructions

TABLE 1.1.3 SIZING OF BATTERY SIDE CABLES AND EXTERNAL BATTERY SIDE FUSES
(Refer to Table 3.1 for more details)

Item (Column 1)	Rated Continuous DC Input Current (Column 2)	NEC Ampacity = 125% of Rated DC Input Current at Column 2 (Column 3)	90°C Copper Conductor. Size Based on NEC Ampacity at Column (3) or 2% Voltage Drop, whichever is Thicker				External Fuse Based on NEC Ampacity at Column (3) (Column 9)
			Cable Running Distance between the Unit and the Battery (Cable Routing In Free Air)		Cable Running Distance between the Unit and the Battery (Cable Routing In Raceway)		
			Up to 5 ft.	Up to 10 ft.	Up to 5 ft.	Up to 10 ft.	
			(Column 5)	(Column 6)	(Column 7)	(Column 8)	
EVO-2212	266A	333A	AWG#3/0	AWG #4/0 (This size, based on 2% voltage drop, is thicker than NEC based size)	2 X AWG #4/0 (MCM 350)	2 X AWG #4/0 (MCM 350)	350A
EVO-2224	133A	166A	AWG #2	AWG #2	AWG #1/0	AWG #1/0	175A
EVO-3012	373A	466A	2 X AWG #3/0 (MCM 300)	2 X AWG #3/0 (MCM 300)	Not recommended	Not recommended	500A
EVO-4024	266A	333A	AWG#3/0	AWG #4/0 (2% voltage drop is thicker)	2 X AWG #4/0 (MCM 350)	2 X AWG #4/0 (MCM 350)	350A
External Charger	50A	63A	AWG #6 (2% voltage drop is thicker)	AWG #2 (2% voltage drop is thicker)	AWG #6	AWG #2 (2% voltage drop is thicker)	70A

TABLE 1.1.4 TIGHTENING TORQUES

Battery Input Connectors	External Charger Input Connectors	AC Input and Output Connectors
70 kgf.cm (5.0 lbf.ft)	35 kgf.cm (2.5 lbf.ft)	7 to 12 kgf.cm (0.5 to 0.9 lbf.ft)

TABLE 1.1.5 USE OF SPECIFIED GROUND FAULT CIRCUIT INTERRUPTER (GFCI) FOR DISTRIBUTION OF AC OUTPUT POWER IN RECREATION VEHICLES

Manufacturer of GFCI	Manufacturers' Model No.	Description
Jiaying Shouxin Electric Technology Co. Ltd	TS-15, TS-20	NEMA5-20, Duplex, 20A NEMA5-15, Duplex, 15A

SECTION 1.2 | Definitions

The following definitions are used in this manual for explaining various electrical concepts, specifications and operations:

Peak Value: It is the maximum value of electrical parameter like voltage / current.

RMS (Root Mean Square) Value: It is a statistical average value of a quantity that varies in value with respect to time. For example, a pure sine wave that alternates between peak values of Positive 169.68V and Negative 169.68V has an RMS value of 120 VAC. Also, for a pure sine wave, the RMS value = Peak value \div 1.414.

Voltage (V), Volts: It is denoted by "V" and the unit is "Volts". It is the electrical force that drives electrical current (I) when connected to a load. It can be DC (Direct Current – flow in one direction only) or AC (Alternating Current – direction of flow changes periodically). The AC value shown in the specifications is the RMS (Root Mean Square) value.

Current (I), Amps, A: It is denoted by "I" and the unit is Amperes – shown as "A". It is the flow of electrons through a conductor when a voltage (V) is applied across it.

Frequency (F), Hz: It is a measure of the number of occurrences of a repeating event per unit time. For example, cycles per second (or Hertz) in a sinusoidal voltage.

Efficiency, (η): This is the ratio of Power Output \div Power Input.

Phase Angle, (ϕ): It is denoted by " ϕ " and specifies the angle in degrees by which the current vector leads or lags the voltage vector in a sinusoidal voltage. In a purely inductive load, the current vector lags the voltage vector by Phase Angle (ϕ) = 90°. In a purely capacitive load, the current vector leads the voltage vector by Phase Angle, (ϕ) = 90°. In a purely resistive load, the current vector is in phase with the voltage vector and hence, the Phase Angle, (ϕ) = 0°. In a load consisting of a combination of resistances, inductances and capacitances, the Phase Angle (ϕ) of the net current vector will be $> 0^\circ < 90^\circ$ and may lag or lead the voltage vector.

Resistance (R), Ohm, Ω : It is the property of a conductor that opposes the flow of current when a voltage is applied across it. In a resistance, the current is in phase with the voltage. It is denoted by "R" and its unit is "Ohm" - also denoted as " Ω ".

Inductive Reactance (X_L), Capacitive Reactance (X_C) and Reactance (X): Reactance is the opposition of a circuit element to a change of electric current or voltage due to that element's inductance or capacitance. Inductive Reactance (X_L) is the property of a coil of wire in resisting any change of electric current through the coil. It is proportional to frequency and inductance and causes the current vector to lag the voltage vector by Phase Angle (ϕ) = 90°. Capacitive reactance (X_C) is the property of capacitive elements to oppose changes in voltage. X_C is inversely proportional to the frequency and capacitance and causes the current vector to lead the voltage vector by Phase Angle (ϕ) = 90°. The unit of both X_L and X_C is "Ohm" - also denoted as " Ω ". The effects of inductive reactance X_L to cause the current to lag the voltage by 90° and that of the capacitive reactance X_C to cause the current to lead the voltage by 90° are exactly opposite and the net effect is a tendency to cancel each other. Hence, in a circuit containing both inductances and capacitances, the net **Reactance (X)** will be equal to the difference between the values of the inductive and capacitive reactances. The net **Reactance (X)** will be inductive if $X_L > X_C$ and capacitive if $X_C > X_L$.

SECTION 1.2 | Definitions

Impedance, Z: It is the vectorial sum of Resistance and Reactance vectors in a circuit.

Active Power (P), Watts: It is denoted as “P” and the unit is “Watt”. It is the power that is consumed in the resistive elements of the load. A load will require additional Reactive Power for powering the inductive and capacitive elements. The effective power required would be the Apparent Power that is a vectorial sum of the Active and Reactive Powers.

Reactive Power (Q), VAR: Is denoted as “Q” and the unit is VAR. Over a cycle, this power is alternatively stored and returned by the inductive and capacitive elements of the load. It is not consumed by the inductive and capacitive elements in the load but a certain value travels from the AC source to these elements in the (+) half cycle of the sinusoidal voltage (Positive value) and the same value is returned back to the AC source in the (-) half cycle of the sinusoidal voltage (Negative value). Hence, when averaged over a span of one cycle, the net value of this power is 0. However, on an instantaneous basis, this power has to be provided by the AC source. Hence, the inverter, AC wiring and over current protection devices have to be sized based on the combined effect of the Active and Reactive Powers that is called the Apparent Power.

Apparent Power (S), VA: This power, denoted by “S”, is the vectorial sum of the Active Power in Watts and the Reactive Power in “VAR”. In magnitude, it is equal to the RMS value of voltage “V” X the RMS value of current “A”. The Unit is VA. Please note that Apparent Power VA is more than the Active Power in Watts. Hence, the inverter, AC wiring and over current protection devices have to be sized based on the Apparent Power.

Maximum Continuous Running AC Power Rating: This rating may be specified as “Active Power” in Watts (W) or “Apparent Power” in Volt Amps (VA). It is normally specified in “Active Power (P)” in Watts for Resistive type of loads that have Power Factor =1. Reactive types of loads will draw higher value of “Apparent Power” that is the sum of “Active and Reactive Powers”. Thus, AC power source should be sized based on the higher “Apparent Power” Rating in (VA) for all Reactive Types of AC loads. If the AC power source is sized based on the lower “Active Power” Rating in Watts (W), the AC power source may be subjected to overload conditions when powering Reactive Type of loads.

Starting Surge Power Rating: Certain loads require considerably higher Starting Surge Power for short duration (lasting from tens of millisecs to few seconds) as compared to their Maximum Continuous Running Power Rating. Some examples of such loads are given below:

- **Electric Motors:** At the moment when an electric motor is powered ON, the rotor is stationary (equivalent to being “Locked”), there is no “Back EMF” and the windings draw a very heavy starting current (Amperes) called “Locked Rotor Amperes” (LRA) due to low DC resistance of the windings. For example, in motor driven loads like Air-conditioning and Refrigeration Compressors and in Well Pumps (using Pressure Tank), LRA may be as high as 10 times its rated Full Load Amps (FLA) / Maximum Continuous Running Power Rating. The value and duration of LRA of the motor depends upon the winding design of the motor and the inertia / resistance to movement of mechanical load being driven by the motor. As the motor speed rises to its rated RPM, “Back EMF” proportional to the RPM is generated in the windings and the current draw reduces proportionately till it draws the running FLA / Maximum Continuous Running Power Rating at the rated RPM.
- **Transformers (e.g. Isolation Transformers, Step-up / Step-down Transformers, Power Transformer in Microwave Oven etc.):** At the moment when AC power is supplied to a transformer, the transformer draws very heavy “Magnetization Inrush Current” for a few millisecs that can reach up to 10 times the Maximum Continuous Rating of the Transformer.

SECTION 1.2 | Definitions

- **Devices like Infrared Quartz Halogen Heaters (also used in Laser Printers) / Quartz Halogen Lights / Incandescent Light Bulbs using Tungsten heating elements:** Tungsten has a very high Positive Temperature Coefficient of Resistance i.e. it has lower resistance when cold and higher resistance when hot. As Tungsten heating element will be cold at the time of powering ON, its resistance will be low and hence, the device will draw very heavy Starting Surge Current with consequent very heavy Starting Surge Power with a value of up to 8 times the Maximum Continuous Running AC Power.
- **AC to DC Switched Mode Power Supplies (SMPS):** This type of power supply is used as stand-alone power supply or as front end in all electronic devices powered from Utility / Grid e.g. in audio/video/ computing devices and battery chargers (Please see Section 4 for more details on SMPS). When this power supply is switched ON, its internal input side capacitors start charging resulting in very high Inrush Current for a few millisecs (Please see Fig 4.1). This inrush current / power may reach up to 15 times the Continuous Maximum Running Power Rating. The inrush current / power will, however, be limited by the Starting Surge Power Rating of the AC source.

Power Factor, (PF): It is denoted by "PF" and is equal to the ratio of the Active Power (P) in Watts to the Apparent Power (S) in VA. The maximum value is 1 for resistive types of loads where the Active Power (P) in Watts = the Apparent Power (S) in VA. It is 0 for purely inductive or purely capacitive loads. Practically, the loads will be a combination of resistive, inductive and capacitive elements and hence, its value will be $> 0 < 1$. Normally it ranges from 0.5 to 0.8.

Load: Electrical appliance or device to which an electrical voltage is fed.

Linear Load: A load that draws sinusoidal current when a sinusoidal voltage is fed to it. Examples are, incandescent lamp, heater, electric motor, etc.

Non-Linear Load: A load that does not draw a sinusoidal current when a sinusoidal voltage is fed to it. For example, non-power factor corrected Switched Mode Power Supplies (SMPS) used in computers, audio video equipment, battery chargers, etc.

Resistive Load: A device or appliance that consists of pure resistance (like filament lamps, cook tops, toaster, coffee maker etc.) and draws only Active Power (Watts) from the inverter. The inverter can be sized based on the Active Power rating (Watts) of the Resistive Load without creating overload (except for resistive loads with Tungsten based heating element like filament lamps, Quartz/Halogen lamps and Quartz / Halogen Infrared heaters. These require higher starting surge power due to lower resistance value when the heating elements are cold).

Reactive Load: A device or appliance that consists of a combination of resistive, inductive and capacitive elements (like motor driven tools, refrigeration compressors, microwaves, computers, audio/ video etc.). The Power Factor (PF) of this type of load is < 1 e.g. AC Motors (PF = 0.4 to 0.8), AC to DC Switch Mode Power Supplies (PF = 0.5 to 0.6), Transformers (PF = 0.8) etc. These devices require Apparent Power (VA) from the inverter to operate. The Apparent Power is a vectorial sum of Active Power (Watts) and Reactive Power (VAR). *The inverter has to be sized based on the higher Apparent Power (VA) and also based on the Starting Surge Power.*

SECTION 1.3 | General Information – Inverter Related

1.3 GENERAL INFORMATION - INVERTER RELATED

General information related to operation and sizing of inverters is given in succeeding sub-sections.

1.3.1 AC Voltage Waveforms

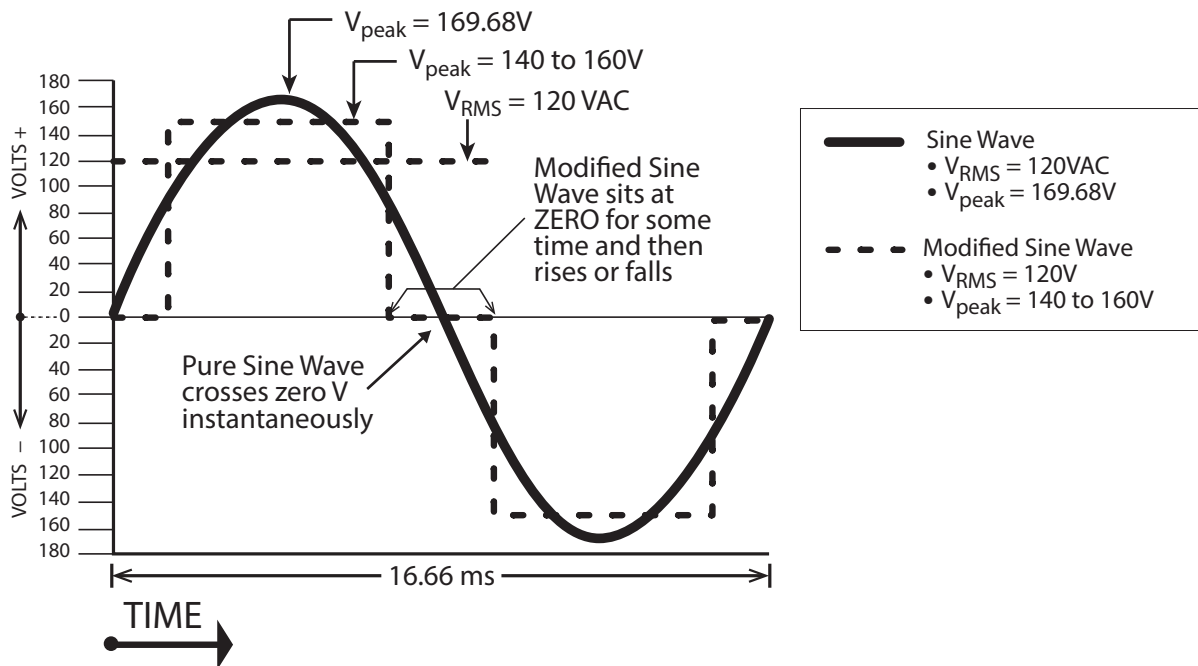

Fig 1.3.1 Pure and Modified Sine Waveforms for 120V, 60 Hz

The 120V output waveform of the Evolution™ series inverters is a Pure Sine Wave like the waveform of Utility / Grid power. Please see Sine Waveform represented in the Fig. 1.3.1 that also shows equivalent Modified Waveform for comparison.

In a Sine Wave, the voltage rises and falls smoothly with a smoothly changing phase angle and also changes its polarity instantly when it crosses 0 Volts. In a Modified Sine Wave, the voltage rises and falls abruptly, the phase angle also changes abruptly and it sits at 0V for some time before changing its polarity. Thus, any device that uses a control circuitry that senses the phase (for voltage / speed control) or instantaneous zero voltage crossing (for timing control) will not work properly from a voltage that has a Modified Sine Waveform.

Also, as the Modified Sine Wave is a form of Square Wave, it is comprised of multiple Sine Waves of odd harmonics (multiples) of the fundamental frequency of the Modified Sine Wave. For example, a 60 Hz Modified Sine Wave will consist of Sine Waves with odd harmonic frequencies of 3rd (180 Hz), 5th (300 Hz), 7th (420 Hz) and so on. The high frequency harmonic content in a Modified Sine Wave produces enhanced radio interference, higher heating effect in inductive loads like microwaves and motor driven devices like hand tools, refrigeration / air-conditioning compressors, pumps etc. The higher frequency harmonics also produce overloading effect in low frequency capacitors due to lowering of their capacitive reactance by the higher harmonic frequencies. These capacitors are used in ballasts for fluorescent lighting for Power Factor improvement and in single-phase induction motors as start and run capacitors. Thus, Modified and Square Wave Inverters may shut down due to overload when powering these devices.

SECTION 1.3 | General Information – Inverter Related

1.3.2 Advantages of Pure Sine Wave Inverters

- The output waveform is a Sine Wave with very low harmonic distortion and cleaner power like Grid / Utility supplied electricity.
- Inductive loads like microwaves, motors, transformers etc. run faster, quieter and cooler.
- More suitable for powering fluorescent lighting fixtures containing Power Factor Improvement Capacitors and single phase motors containing Start and Run Capacitors.
- Reduces audible and electrical noise in fans, fluorescent lights, audio amplifiers, TV, fax and answering machines.
- Does not contribute to the possibility of crashes in computers, weird print outs and glitches in monitors.

Some examples of devices that may not work properly with Modified Sine Wave and may also get damaged are given below:

- Laser printers, photocopiers, and magneto-optical hard drives.
- Built-in clocks in devices such as clock radios, alarm clocks, coffee makers, bread-makers, VCR, microwave ovens etc. may not keep time correctly.
- Output voltage control devices like dimmers, ceiling fan / motor speed control may not work properly (dimming / speed control may not function).
- Sewing machines with speed / microprocessor control.
- Transformer-less capacitive input powered devices like (i) Razors, flashlights, night-lights, smoke detectors etc. (ii) Some re-chargers for battery packs used in hand power tools. *These may get damaged. Please check with the manufacturer of these types of devices for suitability.*
- Devices that use radio frequency signals carried by the AC distribution wiring.
- Some new furnaces with microprocessor control / Oil burner primary controls.
- High intensity discharge (HID) lamps like Metal Halide lamps. *These may get damaged. Please check with the manufacturer of these types of devices for suitability.*
- Some fluorescent lamps / light fixtures that have Power Factor Correction Capacitors. *The inverter may shut down indicating overload.*
- Induction Cooktops.

1.3.3 Power Rating of Inverters



INFO

For proper understanding of explanations given below, please refer to definitions of Active / Reactive / Apparent / Continuous / Surge Powers, Power Factor, and Resistive / Reactive Loads at Section 1.2 under “DEFINITIONS”

The power rating of inverters is specified as follows:

- Maximum Continuous Running Power Rating
- Starting Surge Power Rating

Please read details of the above two types of power ratings in Section 1.2 under “DEFINITIONS”

SECTION 1.3 | General Information – Inverter Related



INFO

The manufacturers' specification for power rating of AC appliances and devices indicates only the Maximum Continuous Running Power Rating. The Starting Surge Power required by some specific types of devices as explained above has to be determined by actual testing or by checking with the manufacturer. This may not be possible in all cases and hence, can be guessed at best, based on some general Rules of Thumb.

Table 1.3.1 provides a list of some common AC appliances / devices that require high Starting Surge Power. An "Inverter Sizing Factor" has been recommended against each which is a Multiplication Factor to be applied to the Maximum Continuous Running Power Rating (Active Power Rating in Watts) of the AC appliance / device to arrive at the Maximum Continuous Running Power Rating of the inverter (Multiply the Maximum Continuous Running Power Rating (Active Power Rating in Watts) of the appliance / device by recommended Sizing Factor to arrive at the Maximum Continuous Running Power Rating of the inverter.

Type of Device or Appliance	Inverter Sizing Factor (See Note 1)
Air Conditioner / Refrigerator / Freezer (Compressor based)	5
Air Compressor	4
Sump Pump / Well Pump / Submersible Pump	3
Dishwasher / Clothes Washer	3
Microwave (where rated output power is the Cooking Power)	2
Furnace Fan	3
Industrial Motor	3
Portable Kerosene / Diesel Fuel Heater	3
Circular Saw / Bench Grinder	3
Incandescent / Halogen / Quartz Lamps	3
Ceramic / PTC (Postive Temperature Coefficient) type of heaters	5
Laser Printer / Other Devices using Infrared, Quartz Halogen Heaters	4
Switch Mode Power Supplies (SMPS): no Power Factor correction	2
Photographic Strobe / Flash Lights	4 (See Note 2)

NOTES FOR TABLE 1.3.1:

1 Multiply the Maximum Continuous Power Rating (Active Power Rating in Watts) of the appliance / device by the recommended sizing factor to arrive at the Maximum Continuous Running Power Rating of the Inverter.

2 For photographic strobe / flash unit, the Surge Power of the inverter should be > 4 times the Watt Sec rating of photographic strobe / flash unit.

1.3.4 Electro-Magnetic Interference (EMI) and FCC Compliance

These inverters contain internal switching devices that generate conducted and radiated electromagnetic interference (EMI). The EMI is unintentional and cannot be entirely eliminated. The magnitude of EMI is, however, limited by circuit design to acceptable levels as per limits laid down in North American FCC Standard FCC Part 15(B), Class A. These limits are designed to provide reasonable protection against harmful interference when the equipment is operated *in a residential environment*. These inverters can conduct and radiate radio frequency energy and, if not installed and

SECTION 1.3 | General Information – Inverter Related

used in accordance with the instruction manual, may cause harmful interference to radio communications. The effects of EMI will also depend upon a number of factors external to the inverter like proximity of the inverter to the EMI receptors, types and quality of connecting wires and cables etc. EMI due to factors external to the inverter may be reduced as follows:

- Ensure that the inverter is firmly grounded to the Ground System of the building or the vehicle.
- Locate the inverter as far away from the EMI receptors like radio, audio and video devices as possible.
- Keep the DC side wires between the battery and the inverter as short as possible.
- Do NOT keep the battery wires far apart. Keep them taped together to reduce their inductance and induced voltages. This reduces ripple in the battery wires and improves performance and efficiency.
- Shield the DC side wires with metal sheathing / copper foil / braiding.
- Use coaxial shielded cable for all antenna inputs (instead of 300 ohm twin leads).
- Use high quality shielded cables to attach audio and video devices to one another.
- Limit operation of other high power loads when operating audio / video equipment.

1.3.5 Characteristics of Switch Mode Power Supplies (SMPS)

Switch Mode Power Supplies (SMPS) are extensively used to convert the incoming AC power into various voltages like 3.3V, 5V, 12V, 24V etc. that are used to power various devices and circuits used in electronic equipment like battery chargers, computers, audio and video devices, radios etc. These power supplies use large capacitors in their input section for filtration. When the power supply is first turned on, there is a very large inrush current drawn by the power supply as the input capacitors are charged (The capacitors act almost like a short circuit at the instant the power is turned on). The inrush current at turn-on is several to tens of times larger than the rated RMS input current and lasts for a few milliseconds. An example of the input voltage versus input current waveforms is given in Fig. 1.3.2. It will be seen that the initial input current pulse just after turn-on is > 15 times larger than the steady state RMS current. The inrush dissipates in around 2 or 3 cycles i.e. in around 33 to 50 milliseconds for 60 Hz sine wave.

Further, due to the presence of high value of input filter capacitors, the current drawn by an SMPS (With no Power Factor correction) is not sinusoidal but non-linear as shown in Fig 1.3.3. The steady state input current of SMPS is a train of non-linear pulses instead of a sinusoidal wave. These pulses are two to four milliseconds duration each with a very high Crest Factor of around 3. Crest Factor is defined by the following equation: **CREST FACTOR = PEAK VALUE ÷ RMS VALUE**

Many SMPS units incorporate “Inrush Current Limiting”. The most common method is the NTC (Negative Temperature Coefficient) resistor. The NTC resistor has a high resistance when cold and a low resistance when hot. The NTC resistor is placed in series with the input to the power supply. The higher cold resistance limits the input current as the input capacitors charge up. The input current heats up the NTC and the resistance drops during normal operation. However, if the power supply is quickly turned OFF and back ON, the NTC resistor will be hot so its low resistance state will not prevent an inrush current event.

The inverter should, therefore, be sized adequately to withstand the high inrush current and the high Crest Factor of the current drawn by the SMPS. Normally, inverters have short duration Surge Power Rating of 2 times their Maximum Continuous Power Rating. **Hence, it is recommended that for purposes of sizing the inverter, to accommodate Crest Factor of 3, the Maximum Continuous Power Rating of the inverter should be > 2 times the Maximum Continuous Rated Power of the SMPS. For example, an SMPS rated at 100 Watts should be powered from an inverter that has Maximum Continuous Power Rating of > 200 Watts.**

SECTION 1.3 | General Information – Inverter Related

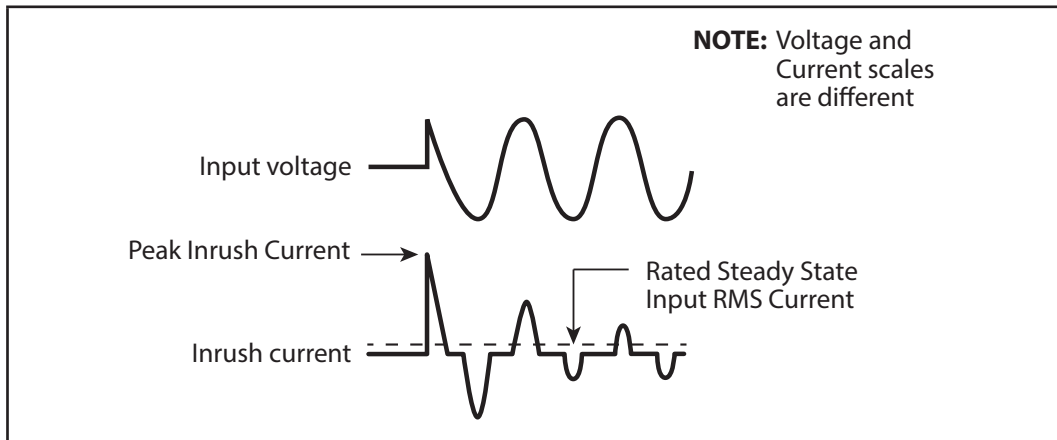

Fig 1.3.2 Inrush current in an SMPS

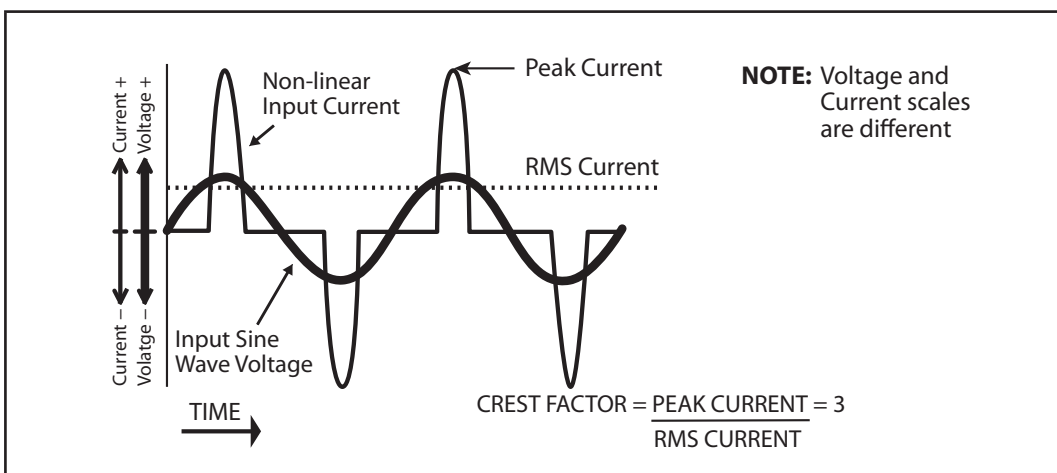

Fig 1.3.3 High Crest Factor of current drawn by SMPS

SECTION 1.4 | General Information – Battery Related



INFO

For complete information on Lead Acid Batteries and Charging Process, please visit www.samlexamerica.com > Support > White Papers > White Paper – Batteries, Chargers and Alternators

1.4.1 Lead Acid Battery – Basic Description And Electro-Chemical Reactions

1.4.1.1 A Lead Acid battery consists of a number of 2 V nominal cells (actual voltage of the cell is around 2.105 V) that are connected in series e.g. a 12 V nominal battery will have six, 2 V nominal cells in series (actual approximate voltage of the 6 cells will be $2.105 \times 6 = 12.63$ V). Each 2 V nominal cell in this battery consists of an independent

SECTION 1.4 | General Information – Battery Related

enclosed compartment that has Positive and Negative Plates (also called Electrodes) dipped in electrolyte that is composed of diluted Sulphuric Acid.

1.4.1.2 A fully charged Lead Acid Battery comprises of (i) **Positive Plates:** Lead Dioxide (PbO_2), (ii) **Negative Plates:** Sponge Lead (Pb) and (iii) **Electrolyte:** Mixture of 65% water and 35% Sulfuric Acid (H_2SO_4) with Specific Gravity = 1.265 at Standard Room Temperature of 77°F / 25°C (Fully charged condition). During discharging, electro-chemical reactions lead to: (i) **At Positive Plates:** Conversion of Lead Dioxide (PbO_2) to soft Lead Sulfate (PbSO_4) crystals, (ii) **At Negative Plates:** Conversion of Sponge Lead (Pb) to soft Lead Sulfate (PbSO_4) crystals and (iii) **In Electrolyte:** Conversion of portion of Sulfuric Acid (H_2SO_4) to water leading to reduction in Specific Gravity (1.120 for fully discharged condition).

1.4.2 Types Of Lead Acid Batteries

1.4.2.1 Sealed Lead Acid (SLA) Or Valve Regulated Lead Acid (VRLA) Batteries: These can either be Gel Cell or AGM (Absorbed Glass Mat). In a Gel Cell battery, the electrolyte is in the form of a gel. In AGM (Absorbed Glass Mat) battery, the electrolyte is soaked in Glass Mat. In both these types, the electrolyte is immobile. There are no refill caps and the battery is totally sealed. Hydrogen and Oxygen released during the charging process is not allowed to escape and is recombined inside the battery through use of Recombinant Catalyst (s). Hence, there is no water loss and the batteries are maintenance free. These batteries have safety valves on each cell to release excessive pressure that may be built up inside the cell. The Gel Cell is the least affected by temperature extremes, storage at low state of charge and has a low rate of self-discharge. An AGM battery will handle overcharging slightly better than the Gel Cell.

1.4.2.2 Non Sealed (Vented / Flooded / Wet Cell) Lead acid Batteries: In these batteries, each individual cell compartment has a refill cap that is used to top up the cell with distilled water and to measure the specific gravity of the electrolyte using a hydrometer. When fully charged, each individual cell has a voltage of approximately 2.105 V and electrolyte specific gravity of 1.265. As the cell discharges, its voltage and specific gravity drop. Thus, a healthy, fully charged, 12 V nominal battery with each of the 6 cells fully charged to 2.105 V will measure a standing voltage of 12.63 V at Standard Room Temperature of 77° F / 25° C. Also, in a healthy battery, all the individual cells will have the same voltage and same specific gravity. If there is a substantial difference in the voltages (0.2 V or higher) and specific gravities of the individual cells (0.015 or more), the cells will have to be “equalized” (Refer to Sections 1.4.3.4 and 1.4.4 regarding further details on equalization).

1.4.2.3 SLI (Starting, Lighting, and Ignition) Batteries: Everybody is familiar with the SLI batteries that are used for automotive starting, lighting, ignition and powering vehicular accessories. SLI batteries are designed to produce high current in short bursts for cranking. This current is also called also called “Cranking Amps”. SLI batteries use lots of thin plates to maximize the surface area of the plates for providing very large Cranking Amps. This allows very high starting current but causes the plates to warp when the battery is cycled. Vehicle starting typically discharges 1%-3% of a healthy SLI battery's capacity. The automotive SLI battery is not designed for repeated deep discharge where up to 80 % of the battery capacity is discharged and then recharged. If an SLI battery is used for this type of deep discharge application, its useful service life will be drastically reduced. This type of battery is not recommended for the storage of energy for inverter backup applications.

1.4.2.4 Deep Cycle Lead Acid Batteries: These batteries are designed with thick-plate electrodes to serve as primary power sources, to have a constant discharge rate, to have the capability to be deeply discharged up to 80 % capacity and to repeatedly accept recharging. They are marketed for use in recreation vehicles (RV), boats and electric golf carts – so they may be referred to as RV batteries, marine batteries or golf cart batteries.

SECTION 1.4 | General Information – Battery Related

1.4.3 Battery Charging Stages:

General descriptions of 4 stages of battery charging are given at Sections 1.4.3.1 to 1.4.3.4 below. Depending upon the type of battery and its application, different Charging Profiles can be created using appropriate charging stages.

NOTE:

7 types of Charging Profiles are available in EVO through programming parameter "CHARGING PROFILE". Refer to Section 5.6 for details.

1.4.3.1 Stage 1 - Constant Current Bulk Charge Stage: In the first stage, known as the Bulk Charge Stage, the charger delivers a constant, maximum charging current that can be safely handled as specified by the battery manufacturer. The value of the Bulk Charge Current depends upon the total Ampere Hour (Ah) capacity of the battery or bank of batteries. A battery should never be charged at very high charging current as very high rate of charging will not return the full 100% capacity as the Gassing Voltage rises with higher charging current due to "Peukert Effect". Also, very high charging current produces higher temperature in the active material of the plates resulting in loss of cohesion and shedding of the active material that settles on the bottom of the plates. Shedding of the active material results in loss of capacity. If the quantity of the shedded active material at the bottom of the plates rises, it may short the cells. As a general thumb rule, the Bulk Charging Current should be limited to 10% to 13% of the Ah capacity of the battery (20 Hour discharge rate). Higher charging current may be used if permitted by the battery manufacturer. This current is delivered to the batteries until the battery voltage approaches its Gassing Voltage of around 2.4 V per cell at 77° F / 25° C or 14.4 V for a 12 V battery and 28.8 volts for a 24 volt battery. The Bulk Charge Stage restores about 75% of the battery's capacity. The Gassing Voltage is the voltage at which the electrolyte in the battery begins to break down into Hydrogen and Oxygen gases. Under normal circumstances, a battery should not be charged at a voltage above its Gassing Voltage (except during Equalization Stage) since this will cause the battery to lose electrolyte and dry out over time. Once the Gassing Voltage is approached, the charger transfers to the next stage, known as the Absorption Stage.



As the Bulk Charge Stage is a constant current stage, the charger does not control the voltage and the voltage seen at the output terminals of the charger will be the actual battery voltage (this will rise slowly towards the Gassing Voltage under the influence of the constant charging current).

1.4.3.2 Stage 2 - Constant Voltage Absorption Stage During the Absorption Stage, the charger changes from constant current to constant voltage charging. The charging voltage is held constant near the Gassing Voltage to ensure that the battery is further charged to the full capacity without overcharging. The Absorption Stage feeds additional 40% of the capacity that adds up to a total charged capacity of around 115% to take care of around 15% loss of charging efficiency. As the output voltage of the charger is held constant, the battery absorbs the charge slowly and the current reduces gradually till all of the soft Lead Sulfate ($PbSO_4$) crystals have been converted to Lead Dioxide (PbO_2) on the Positive Plates and Sponge Lead (Pb) on the Negative Plates. The time the charger is held in the Absorption Stage before it transitions to the next Float Stage is determined in one or more of the following conditions:

- a) **By a fixed timer (e.g. 4 to 8 Hours).** This may result in overcharging of almost fully charged batteries.
- b) **When charge current drops to specified threshold:** Switching over to the Float Stage when the charge current drops below a certain threshold (e.g. 10% of the charger Bulk Charge Current). This may result in overcharging and locking in the Absorption Stage if the battery is feeding an external load that has a value > the specified threshold.

SECTION 1.4 | General Information – Battery Related

- c) **Using Adaptive Charging Algorithm:** This ensures that the battery is completely charged in a safe manner for longer battery life (Suitable for battery that does not have load connected to it). In this algorithm, the time the battery remains in Absorption and Equalization Stages is automatically made proportional to the time the battery remains in the Bulk Charge Stage. A battery that is deeply discharged will remain in Bulk Stage for a longer duration and will require longer time in the Absorption and Equalization Stages for complete charging. On the other hand, a battery that is almost completely charged will remain in the Bulk Stage for a shorter duration and consequently, will remain in Absorption and Equalization stages for a shorter duration. This will prevent overcharging / boiling of the battery. *EVO Series has 2 programmable options to use this Adaptive Charging Algorithm – (i) 3-Stage Adaptive (Table 5.2, Srl. 1) & (ii) 4-Stage Adaptive for Equalization (Section 5.8).*

1.4.3.3 Stage 3 - Constant Voltage Float Stage: The Float Stage is a maintenance stage in which the output voltage is reduced to a constant lower level, typically about 13.5 V for a 12 V battery and 27 V for a 24V battery to maintain the battery's charge without losing electrolyte through gassing and also, to compensate for self discharge. Self discharge of Lead Acid Battery is the electrical Ampere Hour (Ah) capacity that is lost when the battery is not being charged and there is no load connected to it. i.e. sits idle in storage. Self-discharge is caused by electro-chemical processes within the battery and is equivalent to application of a small electrical load. For example, Lead Acid battery stored at 30°C / 86°F would self-discharge at around 1% of remaining capacity every day. Self-discharge increases with increase in temperature. Self-discharge of the battery under long term storage will create condition equivalent to under charging and consequently, lead to "sulfation" as explained at Section 1.4.4.1.

1.4.3.4 Stage 4 - Constant Voltage Equalization Stage: This stage is normally initiated manually because it is not required every time the battery is recharged [*In EVO, it is carried out manually through programming parameter "EQUALIZE-4STAGES"* (See Section 4.4.2.12 in EVO-RC Remote Control Manual attached at Appendix A)]. Normally, only vented / wet cell / flooded batteries are equalized. Some sealed AGM batteries may be equalized if recommended by the manufacturer (e.g. Life Line brand of sealed, AGM batteries). Equalization Stage is normally activated after completion of the Bulk and Absorption Stages. During the Equalization Stage, the battery is intentionally charged at a constant voltage at a value above the Gassing Voltage which is normally in the region of 2.5 to 2.7 V per cell at 25° C / 77° F (e.g. 15 to 16 V for 12 V batteries and 30 to 32 V for 24 V batteries). The time the battery remains in this stage is determined as follows:

- **By a fixed timer (e.g. 4 to 8 Hours):** This may result in overcharging of almost fully charged batteries
- **Using an automatic Adaptive Charging Algorithm:** This ensures that the battery is equalized in a safe manner for longer battery life. EVO Inverter Charger Series uses this Adaptive Charging Algorithm for Equalization. [Refer to Section 1.4.3.2 (c) for details.]

Recommendations of the battery manufacturer are to be followed for equalizing the batteries as the equalization voltage, current, time and frequency will depend upon the specific design of the battery. As a guide, a heavily used flooded battery may need to be equalized once per month and a battery in light duty service, every two to four months. The Equalization Charge Current should be a relatively low current of around 2% to 10% of the Ah capacity of the battery. Such a low current prevents an overcharge condition that results in excessive gassing and excessive loss of water.

1.4.4 Why Flooded / Wet Cell Lead Acid Batteries Are Equalized?

For proper health and long life of a Lead Acid battery, it is required to undergo an Equalization Stage (described at Section 1.4.3.4 above) during the charging process to prevent / reduce the following undesirable effects:

SECTION 1.4 | General Information – Battery Related

1.4.4.1 Sulfation: Section 1.4.1.2 above gives details of basic electrochemical reactions during charging and discharging. If the charging process is not complete due to the inability of the charger to provide the required voltage levels or if the battery is left uncharged for a long duration of time, the soft Lead Sulfate (PbSO_4) crystals on the Positive and Negative plates that are formed during discharging / self discharge are not fully converted back to Lead Dioxide (PbO_2) on the Positive plate and Sponge Lead on the Negative plate and get hardened and are difficult to dislodge through normal charging. These crystals are less-conducting and hence, introduce increased internal resistance in the battery. This increased internal resistance introduces internal voltage drop during charging and discharging. Voltage drop during charging results in overheating and undercharging and formation of more Lead Sulfate (PbSO_4) crystals. Voltage drop on discharging results in overheating and excessive voltage drop in the terminal voltage of the battery. Overall, this results in poor performance of the battery. To dislodge these hardened Lead Sulfate crystals, some chargers are designed to detect a sulfated condition at the start of the charging process and go through an initial De-sulfation Mode that sends high frequency, high voltage pulses at the natural oscillation frequency of the crystals to dislodge the hardened crystals. Sulfation may also be reduced partially by the stirring / mixing action of the electrolyte due to gassing and bubbling because of intentional overcharging during the Equalization Stage.

1.4.4.2 Electrolyte Stratification: Electrolyte stratification can occur in all types of flooded batteries. As the battery is discharged and charged, the concentration of Sulfuric Acid becomes higher at the bottom of the cell and lower at the top of the cell. The low acid concentration reduces capacity at the top of the plates, and the high acid concentration accelerates corrosion at the bottom of the plates and shortens battery life. Stratification can be minimized by the Equalization Stage by raising the charging voltage so that the increased gassing and bubbling agitates / stirs the electrolyte and ensures that the electrolyte has uniform concentration from top to bottom. The stirring action also helps to break up any Lead Sulfate crystals, which may remain after normal charging.

1.4.4.3 Unequal charging of cells: During normal charging, temperature and chemical imbalances prevent some cells from reaching full charge. As a battery is discharged, the cells with lower voltage will be drained further than the cells at higher voltage. When recharged, the cells with the higher voltage will be fully charged before the cells with the lower voltage. The more a battery is cycled, the more cell voltage separation takes place. In a healthy battery, all the individual cells will have the same voltage and same specific gravity. If there is a substantial difference in the cell voltages (0.2 V or more) and in the specific gravities (0.015 or more) of the individual cells, the cells will require equalization. Equalizing batteries helps to bring all the cells of a battery to the same voltage. During the Equalization Stage, fully charged cells will dissipate the charging energy by gassing while incompletely charged cells continue to charge.

1.4.5 Temperature Compensation To Prevent Over And Under Charging

1.4.5.1.1 Electrochemical reactions during charging / discharging of Lead Acid / Nickel Zinc (Ni-Zn) Batteries are affected by changes in the temperature of the electrolyte. These type of batteries have a Negative Temperature Coefficient of Voltage i.e. the battery charging / discharging voltages will fall due to rise in electrolyte temperature and will rise due to fall in electrolyte temperature. Battery manufacturers, therefore, specify battery voltages and capacity at Standard Room Temperature of 77° F / 25° C. The Negative Temperature Coefficient is normally within a range of -3 to -5mV / °C/Cell or (i) -18 to -30mV / °C for a 6-cell, 12V battery or (ii) -36 to -60mV / °C for 12-cell, 24V battery.

1.4.5.1.2 Lithium Ion charging voltages are not affected by temperature and hence, do not require temperature compensation.

SECTION 1.4 | General Information – Battery Related

1.4.5.2 Rise / fall in the temperature of the electrolyte with respect to the Standard Room Temperature of 77° F / 25° C will require temperature compensation. Charging voltages will be required to be reduced at higher electrolyte temperature and increased at lower electrolyte temperature with respect to the Standard Room Temperature of 77° F / 25°C. If charging voltages are not temperature compensated, the battery will boil / be overcharged during higher temperatures and under charged during lower temperatures. This will result in reduced battery life / damage to the battery. *It is, therefore, desirable that a temperature compensated battery charger is used if the Room Temperature swings more than 7° F / 5°C. Temperature compensated battery chargers are provided with either internal or external Temperature Sensor.*

1.4.5.3 Effects of Over Charging: Over charging will lead to excessive amount of decomposition of water into Hydrogen and Oxygen and generation of excessive heat. As the battery electrolyte temperature rises, the battery charging voltage is required to be reduced. However, the charger voltage will not reduce in a charger that has no temperature compensation. This condition will drive more current and ,therefore, heating up the electrolyte even further. This is called “thermal runaway” and may damage the battery within a few hours:

- Flooded battery will lose water / shed pasted material.
- Sealed battery will see rise in internal pressure as the rate of generation of Hydrogen and Oxygen will be more than the designed rate of recombination provided by the Recombinant Catalyst. The battery casing will bulge excessively and the pressure release valves may open.

1.4.5.4 Effects of Under Charging – Sulfation: Refer to Section 1.4.4.1 for details.

1.4.6 Self Discharge Of Lead Acid Batteries:

1.4.6.1 Self discharge of Lead Acid Battery is the electrical Ampere Hour (Ah) capacity that is lost when the battery is not being charged and there is no load connected to it i.e. it sits idle in storage. Self-discharge is caused by electro-chemical processes within the battery and is equivalent to application of a small electrical load. For example, Lead Acid battery stored at 30°C / 86°F would self-discharge at around 1% of remaining capacity every day. Self-discharge increases with increase in temperature. Self-discharge of the battery under long term storage will create condition equivalent to under charging and consequently, lead to sulfation as explained at Sections 1.4.4.1 above. To prevent this, the battery should be “Float Charged” as explained in Section 1.4.3.3.

1.4.6.2 Float Charging of Batteries under Long Term Storage: In order to prevent sulfation due to under charging as a result of self-discharge, Lead Acid Battery under long term storage should be first fully charged and then left under continuous charge using a suitable “Float Charger” that will Float Charge the battery and provide low value of “Float Charge Current” of around 0.1% of the Ah capacity of the battery to compensate for self discharge. *Samlex Model SC-05 and SC-10 SunCharger Solar Panels may be used. These are designed to provide this “Float Charge Current” and thus, prevent sulfation.*

1.4.7 Rated Capacity Specified in Ampere-hour (Ah)

Battery capacity “C” is specified in Ampere-hours (Ah). An Ampere is the unit of measurement for electrical current and is defined as a Coulomb of charge passing through an electrical conductor in one second. The Capacity “C” in Ah relates to the ability of the battery to provide a constant specified value of discharge current (also called “C-rate” - see Section 1.4.10) over a specified time in hours before the battery reaches a specified discharged terminal voltage (Also called “End Point Voltage”) at a specified temperature of the electrolyte. As a benchmark, the automotive battery industry rates batteries at a discharge current or C-rate of C/20 Amperes corresponding to 20 Hour discharge period. The rated capacity “C” in Ah in this case will be the number of Amperes of current the

SECTION 1.4 | General Information – Battery Related

battery can deliver for 20 Hours at 80°F (26.7°C) till the voltage drops to 1.75V / Cell. i.e. 10.5V for 12V battery or 21V for 24V battery. For example, a 100 Ah battery will deliver 5A for 20 Hours.

1.4.8 Rated Capacity Specified in Reserve Capacity (RC)

Battery capacity may also be expressed as Reserve Capacity (RC) in minutes typically for automotive SLI (Starting, Lighting and Ignition) batteries. It is the time in minutes a vehicle can be driven after the charging system fails. This is roughly equivalent to the conditions after the alternator fails while the vehicle is being driven at night with the headlights on. The battery alone must supply current to the headlights and the computer/ignition system. The assumed battery load is a constant discharge current of 25A.

Reserve capacity is the time in minutes for which the battery can deliver 25 Amperes at 80°F (26.7°C) till the voltage drops to 1.75V / Cell i.e. 10.5V for 12V battery or 21V for 24V battery.

Approximate relationship between the two units is: **Capacity “C” in Ah = Reserve Capacity in RC minutes x 0.6**

1.4.9 Typical Battery Sizes

Table 1.4.1 shows details of some popular battery sizes:

TABLE 1.4.1 POPULAR BATTERY SIZES		
BCI* Group	Battery Voltage, V	Battery Capacity, Ah
27 / 31	12	105
4D	12	160
8D	12	225
GC2**	6	220

* Battery Council International; ** Golf Cart

1.4.10 C-rate of Charge / Discharge

1.4.10.1 The rate of charge / discharge of a battery is normally expressed in “C-rate” which is a *multiple* of the *numerical value* of the battery’s Ampere Hour (Ah) Capacity (C) [See Section 1.4.7 for information on Ampere Hour Capacity]. Few examples of C-rates (2C, 1C, 0.2C etc.) for 100Ah capacity battery (C=100 Ah) are given below:

- 2C = (2x100) A = 200A (*As the battery capacity is 100 Ah, the battery will be completely discharged in 0.5 Hrs.*)
- 1C = (1x 100) A = 100A (*As the battery capacity is 100 Ah, the battery will be completely discharged in 1 Hr.*)
- 0.2C (or C/5) = (0.2 x 100) A = 20A (*As the battery capacity is 100 Ah, the battery will be completely discharged in 5 Hrs.*)

1.4.10.2 Example for Determining C-rate of Charge for Particular Value of Charge Current:

- Determine the Ah capacity (C) of the battery – say 100 Ah (C=100 Ah)
- Determine the value of charge current – say 10 Amperes
- C-rate of charge at 10A = *Multiple* of numerical value Ampere Hour Capacity (C) = (10 ÷ 100) C = 1/10 C or 0.1C

1.4.10.3 Example for Determining C-rate of Discharge for Particular Value of Discharge Current:

- Determine the Ah capacity (C) of the battery – say 100 Ah (C=100)
- Determine the value of discharge current – say 20 Amperes
- C-rate of discharge at 20A = *Multiple* of numerical value of Ah Capacity (C) = (20 ÷ 100) C = 1/5 C

SECTION 1.4 | General Information – Battery Related

1.4.10.4 Table 1.4.2 gives some examples of typical C-rates of Discharge and applications:

TABLE 1.4.2 TYPICAL "C-rates" OF DISCHARGE	
C-rate of Discharge (Column 1)	Examples of C-rate of Discharge for 100 Ah capacity battery (Column 2)
2C	200A
1C	100A
C/5 or 0.2C (Inverter application)	20A
C/8 or 0.125C (UPS application)	12.5A
C/10 or 0.1C (Telecom application)	10A
C/20 or 0.05C (Automotive application)	5A
C/100 or 0.01C	1A

1.4.11 Charge / Discharge Curves to Determine State of Charge of Lead Acid Battery Based on its Terminal Voltage and C-rates of Charge / Discharge

1.4.11.1 Fig 1.4.1 shows examples of State of Charge / Discharge Curves for different C-rates for typical 12V / 24V Lead Acid Battery at 80°F / 26.7°C. These curves are used to determine the State of Charge / Discharge of the battery based on its terminal voltage.

The Y-Axis shows the terminal voltage of the battery. The X-Axis shows % State of Charge. % State of Discharge can be converted to % State of Charge using formula:

- % State of Charge = (100% - % State of Discharge) e.g. 80% State of Discharge = 100% - 80% = 20% State of Charge

1.4.11.2 **Example of Determining State of Charge (using Fig 1.4.1) when Charging 12V, 100Ah Battery at C-rate of 0.1C or C/10 or 10A:** Refer to Charge Curve marked C\10 of the upper 4 curves marked "CHARGE". States of Charge at different battery terminal voltages will be: (a) At 5.3V = 100% charged; (b) At 14.3V = 90% charged; (c) At 13.5V = 70% charged; (d) At 12.5V = 15% charged

1.4.11.3 **Example of Determining State of Discharge (using Fig 1.4.1) when Discharging 12V, 100Ah Battery at C-rate of 0.33C or C/3 or 33.3A:** Refer to Charge Curve marked C\3 of the lower 4 curves marked "DISCHARGE". States of Discharge at different battery terminal voltages will be: [a] At 9.5V = 100% discharged (0% charged); [b] At 10.4V = 80% discharged (20% charged); [c] At 11.5V = 28% discharged (72% charged) and [d] 11.75V = 0% discharged (100% charged)

SECTION 1.4 | General Information – Battery Related

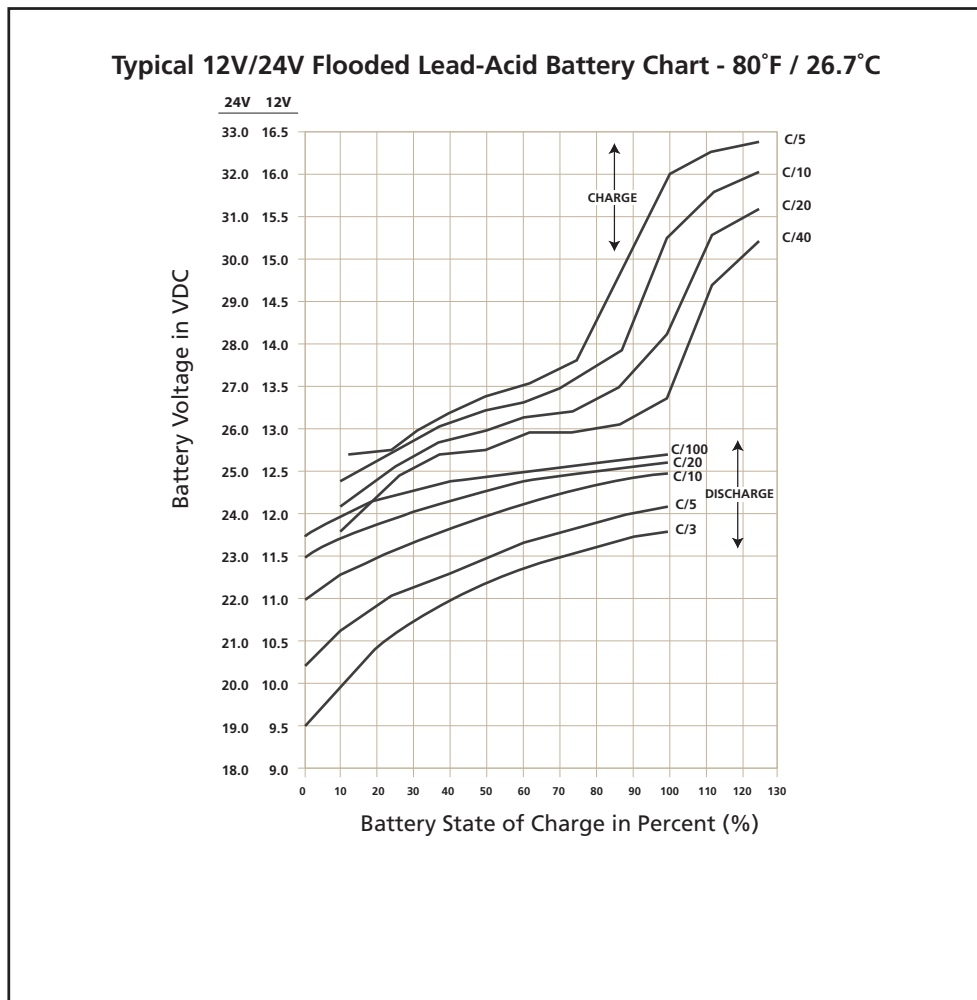

Fig 1.4.1 Charging / Discharging Curves for Typical 12V/24V Flooded Lead Acid Battery

1.4.12 Reduction in Usable Capacity at Higher Discharge Rates – Typical in Inverter Application

As stated earlier, the Ah capacity of automotive battery is normally applicable at C-rate of C/20 (or 0.05C). As the discharge rate is increased as in cases where the inverters are driving higher capacity loads, the usable Ah capacity reduces due to "Peukert Effect". This relationship is not linear but is more or less according to the Table 1.4.3.

TABLE 1.4.3 BATTERY CAPACITY VERSUS RATE OF DISCHARGE – C-RATE	
C-rate Discharge Current	Usable Capacity (%)
C/20 or, 0.05C	100%
C/10 or, 0.10C	87%
C/8 or, 0.125C	83%
C/6 or, 0.17C	75%
C/5 or, 0.20C	70%
C/3 or, 0.34C	60%
C/2 or, 0.50C	50%
1C	40%

SECTION 1.4 | General Information – Battery Related

Table 1.4.3 shows that a 100 Ah capacity battery will deliver 100% (i.e. full 100 Ah) capacity if it is slowly discharged over 20 Hours at the rate of 5 Amperes (50W output for a 12V inverter and 100W output for a 24V inverter). However, if it is discharged at a rate of 50 Amperes (500W output for a 12V inverter and 1000W output for a 24V inverter) then theoretically, it should provide $100 \text{ Ah} \div 50 = 2 \text{ Hours}$. However, Table 1.4.3 above shows that for 2 Hours discharge rate, the capacity is reduced to 50% i.e. 50 Ah. Therefore, at 50 Ampere discharge rate (500W output for a 12V inverter and 1000W output for a 24V inverter) the battery will actually last for $50 \text{ Ah} \div 50 \text{ Amperes} = 1 \text{ Hour}$.

1.4.13 State of Charge (SOC) of a Battery – Based on “Standing Voltage”

The “Standing Voltage” of a battery under open circuit conditions (no charger or load connected to it) can approximately indicate the State of Charge (SOC) of the battery. *The “Standing Voltage” is measured after disconnecting any charging device(s) and the battery load(s) and letting the battery “stand” idle for 3 to 8 hours before the voltage measurement is taken.* Table 1.4.4 shows the State of Charge versus Standing Voltage for a typical 12V/24V battery system at 80°F (26.7°C).

Percentage of Full Charge	Standing Voltage of Individual Cells	Standing Voltage of 12V Battery	Standing Voltage of 24V Battery
100%	2.105V	12.63V	25.26V
90%	2.10V	12.6V	25.20V
80%	2.08V	12.5V	25.00V
70%	2.05V	12.3V	24.60V
60%	2.03V	12.2V	24.40V
50%	2.02V	12.1V	24.20V
40%	2.00V	12.0V	24.00V
30%	1.97V	11.8V	23.60V
20%	1.95V	11.7V	23.40V
10%	1.93V	11.6V	23.20V
0%	= / < 1.93V	= / < 11.6V	= / < 23.20V

Check the individual cell voltages / specific gravity. If the inter-cell voltage difference is more than a 0.2V, or the specific gravity difference is 0.015 or more, the cells will require equalization. Refer to Section 1.4.3.4 and 1.4.4 regarding details on equalization). *Please note that only non-sealed / vented / flooded / wet cell batteries are equalized. Do not equalize sealed / VRLA type of AGM or Gel Cell Batteries.*

1.4.14 State of Discharge of a Loaded Battery – Low Battery / DC Input Voltage Alarm and Shutdown in Inverters

Most inverter hardware estimate the State of Discharge of the loaded battery by measuring the voltage at the inverter’s DC input terminals [considering that the DC input cables are thick enough to allow a negligible voltage drop between the battery and the inverter].

SECTION 1.4 | General Information – Battery Related

Inverters are provided with a buzzer alarm to warn that the loaded battery has been deeply discharged to around 80% of the rated capacity. *Normally, the buzzer alarm is triggered when the voltage at the DC input terminals of the inverter has dropped to around 10.5V for a 12V battery or 21V for 24V battery at C-rate discharge current of C/5 Amps and electrolyte temp. of 80°F.* The inverter is shut down if the terminal voltage at C/5 discharge current falls further to 10V for 12V battery or 20V for 24V battery.

The State of Discharge of a battery is estimated based on the measured terminal voltage of the battery. The terminal voltage of the battery is dependent upon the following:

- **Temperature of the battery electrolyte:** Temperature of the electrolyte affects the electrochemical reactions inside the battery and produces a Negative Voltage Coefficient – during charging / discharging, the terminal voltage drops with rise in temperature and rises with drop in temperature.
- **The amount of discharging current or “C-rate”:** A battery has non linear internal resistance and hence, as the discharge current increases, the battery terminal voltage decreases non-linearly.

The discharge curves in Fig. 1.4.1 show the % State of Charge versus the terminal voltage of typical Flooded Lead Acid Battery under different charge /discharge currents, i.e. “C-rates” and fixed temperature of 80°F. *(Please note that the X-Axis of the curves shows the % of State of Charge. The % of State of Discharge will be 100% - % State of Charge).*

1.4.14.1 Low DC Input Voltage Alarm in Inverters

As stated earlier at Section 1.4.14, the buzzer alarm is triggered when the voltage at the DC input terminals of the inverter has dropped to around 10.5V for a 12V battery or 21V for 24V battery at C-rate discharge current of C/5 Amps. Please note that the terminal voltage relative to a particular State of Discharge decreases with the rise in the value of the discharge current. For example, terminal voltages for a State of Discharge of 80% (State of Charge of 20%) for various discharge currents will be as given at Table 1.4.5 (Refer to Fig. 1.4.1 for parameters and values shown in Table 1.4.5):

TABLE 1.4.5 TERMINAL VOLTAGE AND SOC OF LOADED BATTERY				
Discharge Current: C-rate	Terminal Voltage at 80% State of Discharge (20% SOC)		Terminal Voltage When Completely Discharged (0% SOC)	
	12V	24V	12V	24V
C/3 A	10.45V	20.9V	09.50V	19.0V
C/5 A	10.90V	21.8V	10.30V	20.6V
C/10 A	11.50V	23.0V	11.00V	22.0V
C/20 A	11.85V	23.7V	11.50V	23.0V
C/100 A	12.15V	24.3V	11.75V	23.5V

In the example given above, the 10.5V / 21.0V Low Battery / DC Input Alarm would trigger at around 80% discharged state (20% SOC) when the C-rate discharge current is C/5 Amps. However, for lower C-rate discharge current of C/10 Amps and lower, the battery will be almost completely discharged when the alarm is sounded. *Hence, if the C-rate discharge current is lower than C/5 Amps, the battery may have completely discharged by the time the Low DC Input Alarm is sounded.*

SECTION 1.4 | General Information – Battery Related

In view of the above, it may be seen that a fixed Low DC Input Voltage Alarm is not useful. Temperature of the battery further complicates the situation. All the above analysis is based on battery electrolyte temperature of 80°F. The battery capacity varies with temperature. Battery capacity is also a function of age and charging history. Older batteries have lower capacity because of shedding of active materials, sulfation, corrosion, increasing number of charge / discharge cycles etc. Hence, the State of Discharge of a battery under load cannot be estimated accurately. However, the low DC input voltage alarm function is designed to protect the inverter from excessive current drawn at the lower voltage.

1.4.14.2 Low DC Input Voltage Shutdown in Inverters

As explained above at Section 1.4.14, at around 80% State of Discharge of the battery at C-rate discharge current of around C/5 Amps, the Low DC Input Voltage Alarm is sounded at around 10.5V for a 12V battery or, at around 21V for 24V battery to warn the user to disconnect the battery to prevent further draining of the battery. If the load is not disconnected at this stage, the batteries will be drained further to a lower voltage and to a completely discharged condition that is harmful for the battery and for the inverter.

Inverters are normally provided with a protection to shut down the output of the inverter if the DC voltage at the input terminals of the inverter drops below a threshold of around 10V for a 12V battery or, 20V for 24V battery. Referring to the Discharge Curves given in Fig 1.4.1, the State of Discharge for various C-rate discharge currents for battery voltage of 10V / 20V is as follows: *(Please note that the X-Axis of the curves shows the % of State of Charge. The % of State of Discharge will be 100% - % State of Charge):*

- 85% State of Discharge (15% State of Charge) at very high C-rate discharge current of C/3 Amps.
- 100% State of Discharge (0 % State of Charge) at high C-rate discharge current of C/5 Amps.
- 100% discharged (0% State of charge) at lower C-rate Discharge current of C/10 Amps.

It is seen that at DC input voltage of 10V / 20V, the battery is completely discharged for C-rate discharge current of C/5 and lower.

In view of the above, it may be seen that a fixed Low DC Input Voltage Shutdown is not useful. Temperature of the battery further complicates the situation. All the above analysis is based on battery electrolyte temperature of 80°F. The battery capacity varies with temperature. Battery capacity is also a function of age and charging history. Older batteries have lower capacity because of shedding of active materials, sulfation, corrosion, increasing number of charge / discharge cycles etc. Hence, the State of Discharge of a battery under load cannot be estimated accurately. However, the low DC input voltage shut-down function is designed to protect the inverter from excessive current drawn at the lower voltage.

SECTION 1.4 | General Information – Battery Related

1.4.15 Depth of Discharge of Battery and Battery Life

The more deeply a battery is discharged on each cycle, the shorter the battery life. Using more batteries than the minimum required will result in longer life for the battery bank. A typical cycle life chart is given in the Table 1.4.6 below:

Depth of Discharge % of Ah Capacity	Cycle Life of Group 27 /31	Cycle Life of Group 8D	Cycle Life of Group GC2
10	1000	1500	3800
50	320	480	1100
80	200	300	675
100	150	225	550

NOTE: It is recommended that the depth of discharge should be limited to 50%.

1.4.16 Series and Parallel Connection of Batteries

Refer to details at Section 3.4.

1.4.17 Sizing the Inverter Battery Bank

One of the most frequently asked questions is, “how long will the batteries last?” This question cannot be answered without knowing the size of the battery system and the load on the inverter. Usually this question is turned around to ask “How long do you want your load to run?”, and then specific calculation can be done to determine the proper battery bank size. There are a few basic formulae and estimation rules that are used:

1. Active Power in Watts (W) = Voltage in Volts (V) x Current in Amperes (A) x Power Factor
2. For an inverter running from a 12V battery system, the approximate DC current required from the 12V batteries is the AC power delivered by the inverter to the load in Watts (W) divided by 10 & for an inverter running from a 24V battery system, the approximate DC current required from the 24V batteries is the AC power delivered by the inverter to the load in Watts (W) divided by 20.
3. Energy required from the battery = DC current to be delivered (A) x Time in Hours (H).

The first step is to estimate the total AC watts (W) of load(s) and for how long the load(s) will operate in hours (H). The AC watts are normally indicated in the electrical nameplate for each appliance or equipment. In case AC watts (W) are not indicated, Formula 1 given above may be used to calculate the AC watts. The next step is to estimate the DC current in Amperes (A) from the AC watts as per Formula 2 above. An example of this calculation for a 12V inverter is given below:

Let us say that the total AC Watts delivered by the inverter = 1000W.

Then, using Formula 2 above, the approximate DC current to be delivered by the 12V batteries = $1000W \div 10 = 100$ Amperes, or by 24V batteries = $1000W \div 20 = 50A$.

Next, the energy required by the load in Ampere Hours (Ah) is determined.

For example, if the load is to operate for 3 hours then as per Formula 3 above, the energy to be delivered by the 12V batteries = $100 \text{ Amperes} \times 3 \text{ Hours} = 300 \text{ Ampere Hours (Ah)}$, or by the 24V batteries = $50A \times 3 \text{ Hrs} = 150 \text{ Ah}$.

SECTION 1.4 | General Information – Battery Related

Now, the capacity of the batteries is determined based on the run time and the usable capacity.

From Table 1.4.3 “Battery Capacity versus Rate of Discharge”, the usable capacity at 3 Hour discharge rate (C/3) is 60%. Hence, the actual capacity of the 12V batteries to deliver 300 Ah will be equal to: $300 \text{ Ah} \div 0.6 = 500 \text{ Ah}$, and the actual capacity of the 24V battery to deliver 150 Ah will be equal to $150 \text{ Ah} \div 0.6 = 250 \text{ Ah}$.

And finally, the actual desired rated capacity of the batteries is determined based on the fact that normally only 80% of the capacity will be available with respect to the rated capacity due to non availability of ideal and optimum operating and charging conditions. So the final requirements will be equal to:

FOR 12V BATTERY: $500 \text{ Ah} \div 0.8 = 625 \text{ Ah}$ (note that the actual energy required by the load was 300 Ah).

FOR 24V BATTERY: $250 \text{ Ah} \div 0.8 = 312.5 \text{ Ah}$ (Note that the actual energy required was 150 Ah).

It will be seen from the above that the final rated capacity of the batteries is almost 2 times the energy required by the load in Ah. Thus, as a Rule of Thumb, the Ah capacity of the batteries should be twice the energy required by the load in Ah.

1.14.18 Charging Batteries

Batteries can be charged by using good quality AC powered battery charger or from alternative energy sources like solar panels, wind or hydro systems. Make sure an appropriate Battery Charge Controller is used. It is recommended that batteries may be charged at 10% to 20% of their Ah capacity (Ah capacity based on 20 Hr Discharge Rate). Based on the application, batteries may be charged using 2-Stage / 3-Stage / 4-Stage Charging Profiles as follows:

- **Float Application Charging (2-Stage)**
Stage 1 (Bulk Stage at constant current) → Stage 2 (Absorption Stage at constant voltage. May also be called Float Stage in some applications).
- **Normal Charging (3-Stages)**
Stage 1 (Bulk Stage at constant current) → Stage 2 (Absorption Stage at constant voltage) → Stage 3 (Float Stage at constant voltage)
- **Equalization Charging (4-Stages)**
Stage 1 (Bulk Stage at constant current) → Stage 2 (Absorption Stage at constant voltage) → Stage 3 (Equalization Stage at constant voltage) → Stage 4 (Float Stage at constant voltage)

Please refer to Section 5 for details of charging algorithm used in the Battery Charger Section of EVO™ Series Inverter/Charger.

SECTION 2 | Components & Layout

2.1 MAIN UNIT: LAYOUT-FRONT (FIG 2.1)

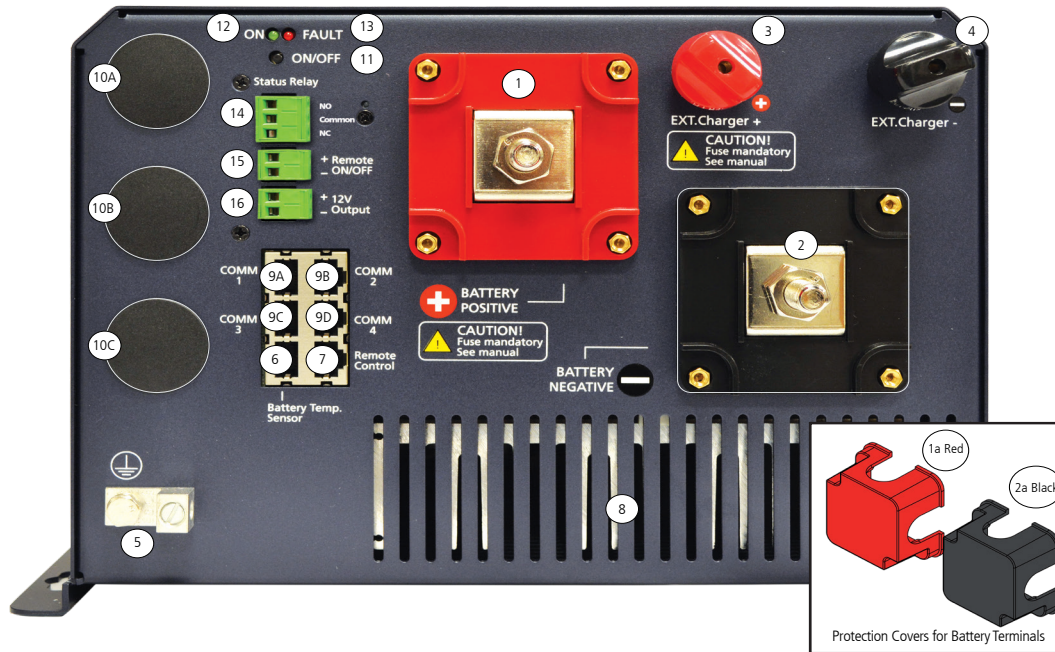

Legend for Fig 2.1

1. Battery Positive (+) Input Connector – Stud & Nut, M10 (Pitch 1.5 mm) (RED Protection Cover 1(a) is removed)
 - 1a. RED Protection Cover For Battery Positive (+) Input Connector
2. Battery Negative (-) Input Connector – Stud & Nut, M10 (Pitch 1.5 mm) (Black Protection Cover 2(a) is removed)
 - 2a. Black Protection Cover for Battery Negative (-) Input Connector
3. External Charger (+) Input Connector – Stud & Thumb Nut, M12 (Pitch 0.75 mm)
4. External Charger (-) Input Connector – Stud & Thumb Nut, M12 (Pitch 0.75 mm)
5. DC Side Grounding Connector – Hole Dia 6.5mm for wire sizes up to 25mm² (AWG #4). Set Screw M-8. This is internally connected to the metal chassis of the unit.
6. RJ-45 Jack [*Pinout at Fig 3.13*] is used for the following:
 - i. Connecting Battery Temperature Sensor EVO-BCTS (See Fig 2.5) for Lead Acid Batteries (See Section 3.15)
 - ii. Feeding potential free contact switching signal from Lithium Ion Battery Management System (BMS) to stop charging / inverting [*See Sections 3.16 and 5.11.2*]
7. RJ-45 Jack for EVO-RC Remote Control
8. Air inlet vents for 2 internal cooling fans [Additional air inlet vents at the bottom (not shown)]
- 9A, 9B. RJ-45 Jacks for Communication Ports "COMM 1" and "COMM 2" - For RS-485 networking and MODBUS Serial Communication Protocol
- 9C, 9D. RJ-45 Jacks for Communication Ports "COM 3" and "COM 4" - For "CANbus" Serial Communication Protocol (for future use)
- 10A to 10C. Knock outs for AC wiring inlet/exit wiring entry (Diameter: 27.8mm / 1 3/32") (For 3/4" conduit/fittings)
11. ON/OFF Push Button
12. Green LED "ON"
13. Red LED "Fault"
14. Output Terminals for Status Relay - Screw M 2.5; Wire size: up to 4mm² / AWG #12
 - Contact ratings: 125 VAC / 30 VDC ; 3A
 - NO (Normally Open)
 - Common
 - NC (Normally Closed)

}	(i) When the Relay is OFF, "NO" and "Common" contacts are open and "NC" and "Common" contacts are closed.
}	(ii) When the Relay is ON, "NO" and "Common" contacts are closed and "NC" and "Common" contacts are open.
15. +12V Input Terminals for "Remote On Off" (9 to 15V, 3mA) - Screw M 2.5; AWG #30 to #12
16. Output Terminals for +12.5 to 11.5 VDC source (up to 100mA) (available only when the unit is ON) - Screw M 2.5; Wire size: up to 4mm² / AWG#12

SECTION 2 | Components & Layout

2.2 MAIN UNIT: LAYOUT-BACK (FIG 2.2)

Legend for Fig 2.2

1. Air outlet vents for 2 internal fans



Fig 2.2 Layout-Back

2.3 MAIN UNIT: LAYOUT-AC SIDE (FIG 2.3)

Legend for Fig 2.3

1. Cover plate for pocket for AC Input/Output terminals
2. Pocket for AC Input/Output Terminals (behind cover plate 1)
3. AC Input/Output Terminal Block
 - Terminal hole diameter: 6mm for up to AWG #6
 - Set Screw: M4
4. Grid Input - Line
5. Grid Input - Ground
6. Grid Input - Neutral
7. Generator Input - Line
8. Generator Input - Ground
9. Generator Input - Neutral
10. AC Output - Line
11. AC Output - Ground
12. AC Output - Neutral
13. Male/Female Insulated Quick Disconnect "QD" for disabling Output Neutral to Chassis Ground bond in Inverter Mode *[Please see Section 4.5.1(c) and Fig 3.12]*

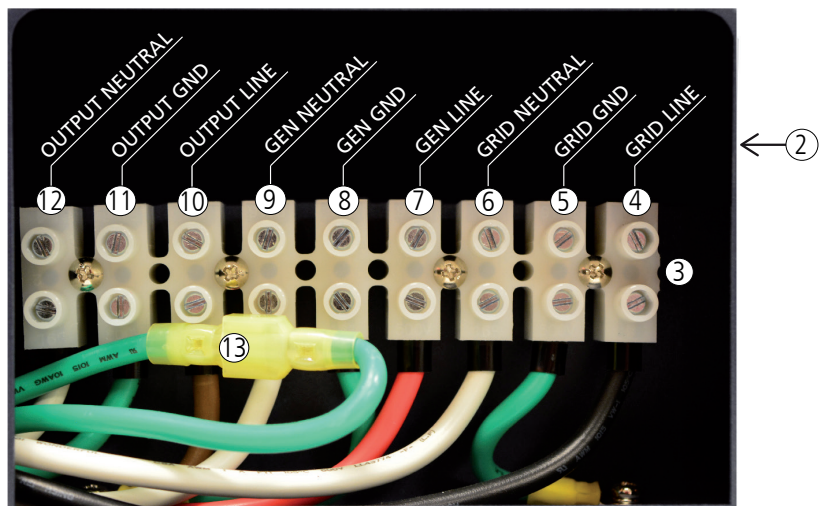
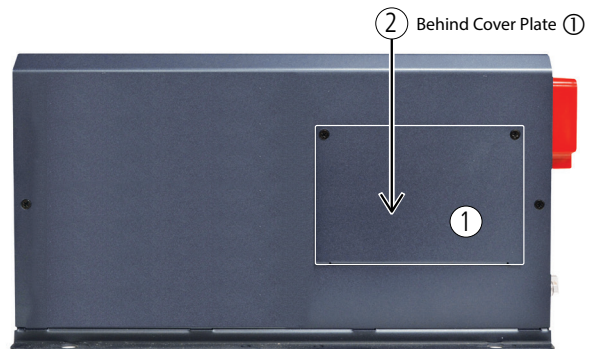

Fig 2.3 Layout-AC Side (Behind Cover Plate 1)

SECTION 2 | Components & Layout

2.4 REMOTE CONTROL EVO-RC (FIG 2.4) [OPTIONAL]

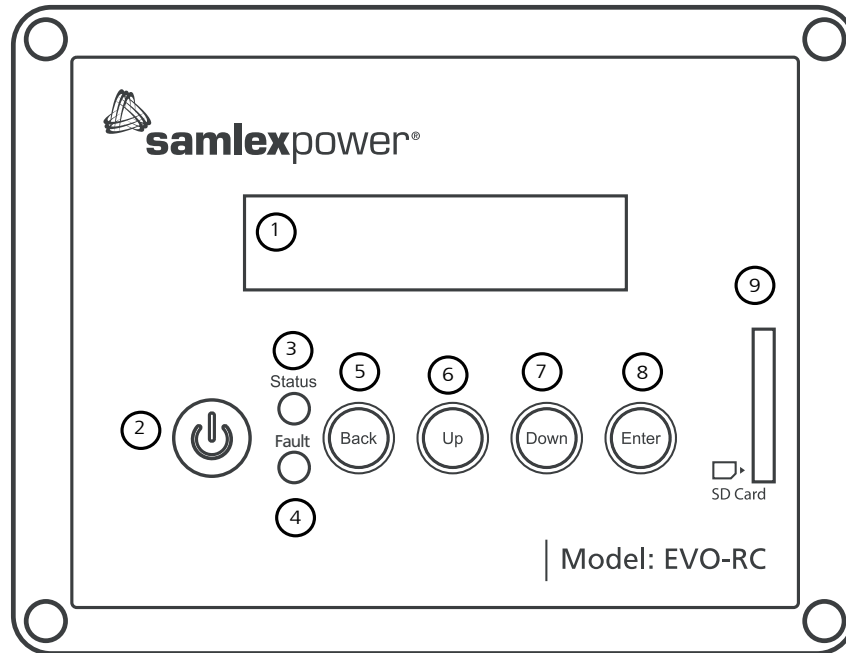

Fig 2.4(a) Optional Remote Control EVO-RC

1. LCD Screen - 2 rows of 16 characters each
2. ON/OFF Key
3. Green LED "Status"
4. Red LED "Fault"
5. Navigation Key "Back"
6. Navigation Key "Up"
7. Navigation Key "Down"
8. Navigation Key "Enter"
9. SD Card Slot - FAT16/32 format; Up to 16GB
10. RJ-45 Jack (At the back-not shown)
11. RJ-45 Data Cable (Straight Wired), 10 meter/33 feet length {Fig 2.4(b)}



Fig 2.4(b) Cable for Remote Control

SECTION 2 | Components & Layout

2.5 BATTERY TEMPERATURE SENSOR EVO-BCTS [FIG 2.5 (a)]

Refer to section 3.15 for details.

Note: Mount the sensor on the Positive or Negative terminal stud on the battery as shown in Fig 2.5(b)

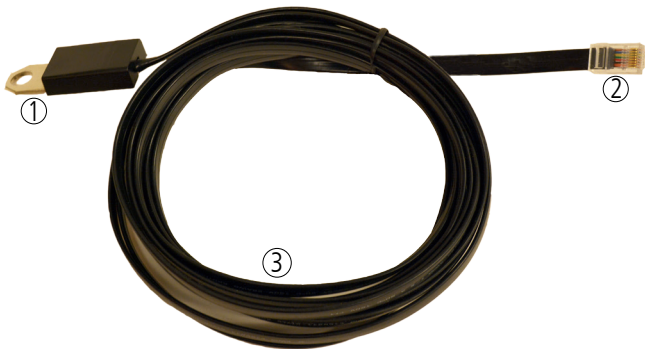

Fig 2.5(a) Temperature Sensor Model EVO-BCTS



Fig 2.5(b) Temperature Sensor Installation

LEGEND for Fig. 2.5(a)

1. Temperature Sensor with Ring Terminal: Mounting hole: 10mm/0.39" suitable for 3/8" or 5/16" battery studs
2. RJ-45 Plug: Plug this into the RJ-45 Jack marked "Battery Temp. Sensor" (6, Fig 2.1). See pinout of mating RJ-45 at Fig 3.13.
3. 5 meter/16.5 ft cable

2.6 CONTENTS OF PACKAGE

- Inverter/Charger
- Temperature Sensor EVO-BCTS [Fig 2.5(a)]
- DC Terminal Covers (1a, 1b: Fig 2.1) (Fitted on the unit with 2 screws each)
- Mating Connectors (14, 15, 16: Fig 2.1)



2 pieces (15, 16 Fig 2.1)



1 piece (14 Fig 2.1)

- Wire End Terminals for AC Wiring (Fig 3.11)

Model	AWG#10	AWG #8	AWG#6
EVO-2212 and EVO-2224	3	6	-
EVO-3012 and EVO-4024	-	9	6

- Owner's Manual
- Quick Start Guide

SECTION 3 | Installation

3.1 SAFETY OF INSTALLATION



WARNING!

Please ensure safety instructions given under Section 1 are strictly followed.



MISE EN GARDE

Se il vous plaît assurer consignes de sécurité fournies à la section 1 sont strictement suivies.

3.2 OVERALL DIMENSIONS

The overall dimensions and the location of the mounting holes are shown in Fig. 3.1.

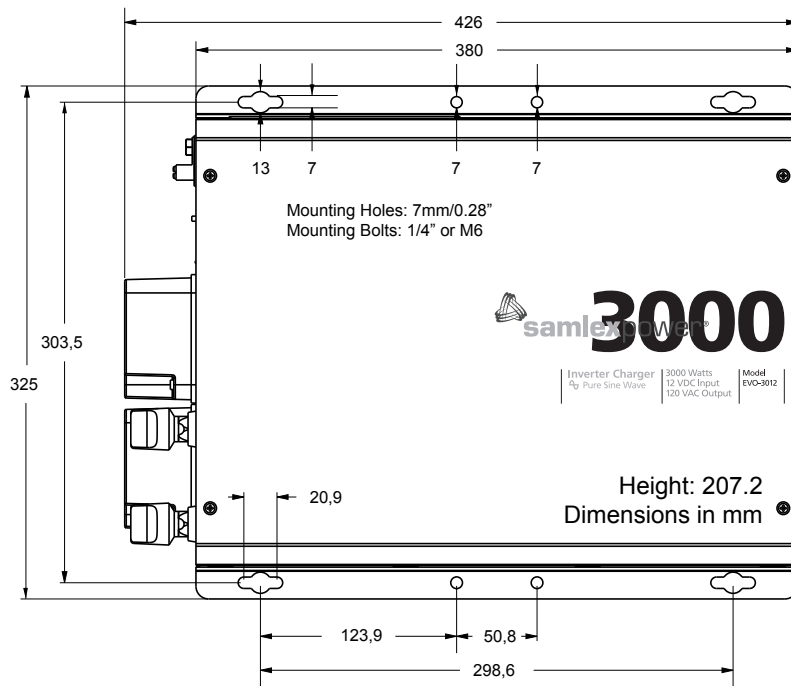

Fig. 3.1 Mounting Dimensions

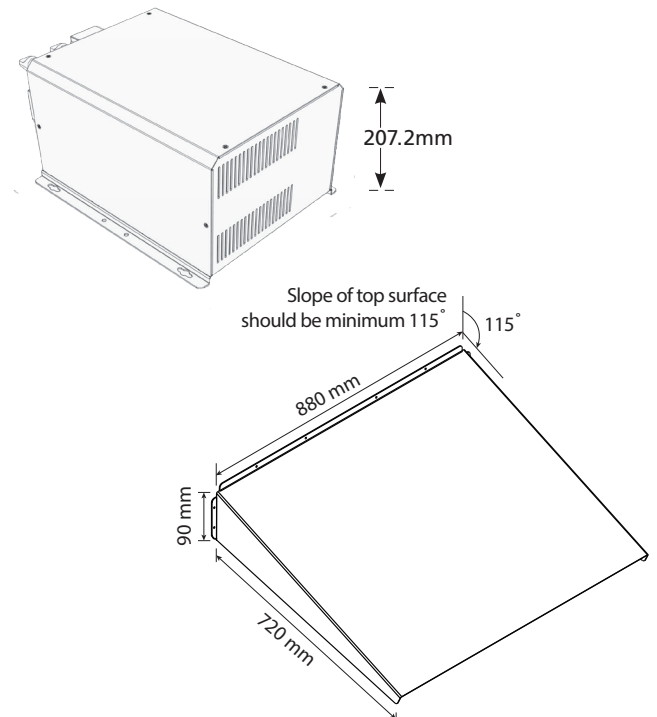

Fig. 3.1(a) Dimensions of Drip Shield

3.3 MOUNTING OF THE UNIT

In order to meet the regulatory safety requirements, the mounting has to satisfy the following requirements:

- Mount on a non-combustible material
- The mounting surface should be able to support a weight of at least 60 Kg / 132 lbs. Use 4 pcs of 1/4" or M6 mounting bolts and lock washers
- Installation on marine craft and vessels will require use of Drip Shield on top of the unit to protect against ingress of water dripping from top. Drawing of Drip Shield is given at Fig 3.1(a). Configurations using the Drip Shield are shown under "Mounting Orientation".

Cooling: The unit has openings on the front, bottom and back for cooling and ventilation. Ensure that these openings are not blocked or restricted. Install in cool, dry and well ventilated area.

SECTION 3 | Installation



CAUTION!

Ensure there is OVER 200 mm clear space surrounding the inverter for ventilation.



ATTENTION!

Assurer qu'il y a PLUS QUE 200 mm d'espace DÉGAGÉ entourant l'onduleur pour faciliter la ventilation.

Mounting Orientation:

- Mount horizontally on a horizontal surface (e.g. table top or a shelf). Please see Fig. 3.2.

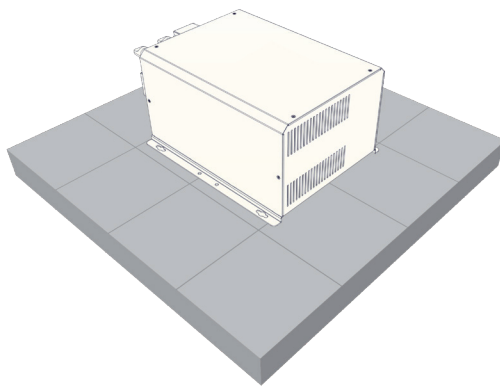

(a) Non Marine Installation

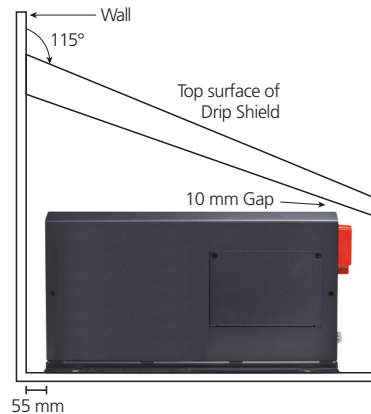

(b) Marine Installation

Fig 3.2 Mounting Arrangement: Horizontally On Horizontal Surface

- Mount horizontally on a vertical surface (like a wall) with the fan axis horizontal and the DC input terminals facing left. Please see Fig. 3.3.

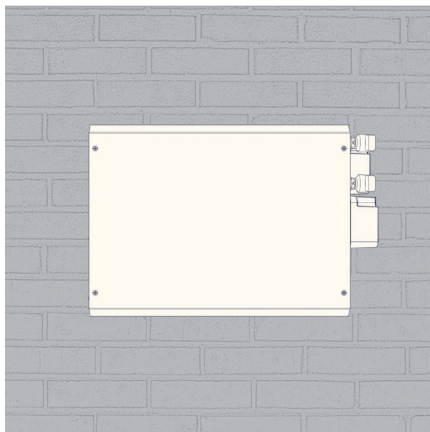

(a) Non Marine Installation

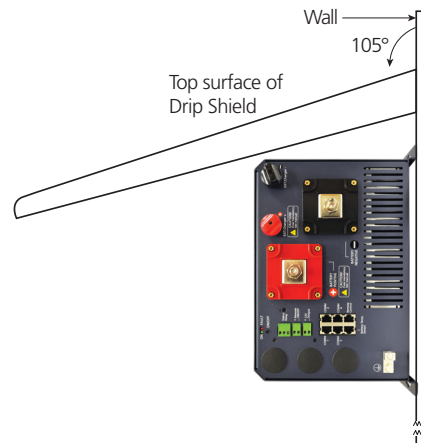

(b) Marine Installation

Fig 3.3 Mounting Arrangement 1: On Vertical Surface

SECTION 3 | Installation

- Mount vertically on a vertical surface, see Fig. 3.4. Protect against possibility of small objects or water entering the ventilation openings on the top. (If necessary, install a suitable sloping guard at least 200mm from the top surface). Also, ensure there is no combustible material directly under the unit.

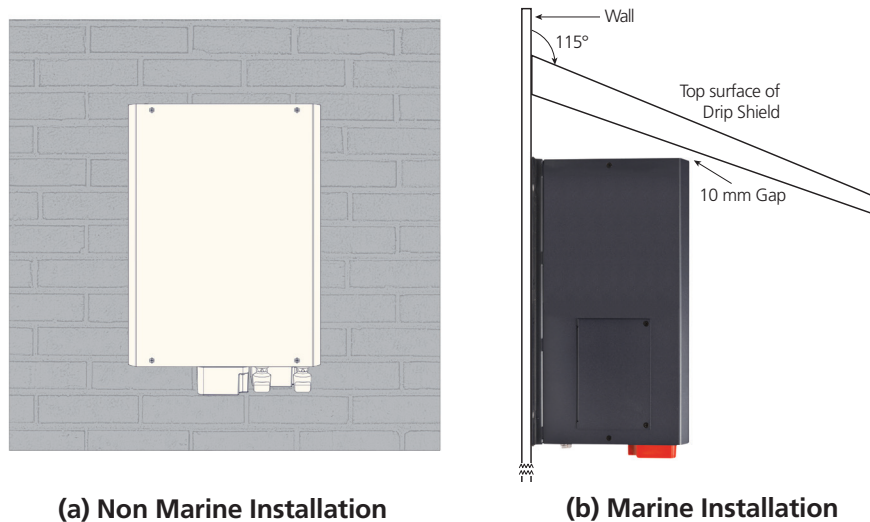

Fig 3.4 Mounting Arrangement 2: On Vertical Surface

3.4 INSTALLING BATTERIES - SERIES AND PARALLEL CONNECTION

Batteries are normally available in voltages of 2V, 6V and 12V and with different Ah capacities. A number of individual batteries can be connected in series and in parallel to form a bank of batteries with the desired increased voltage and capacity.

3.4.1 Series Connection

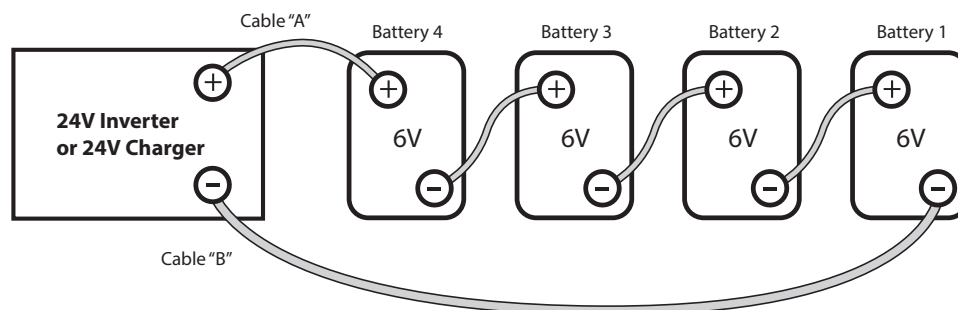

Fig 3.5 Series Connection

When two or more batteries are connected in series, their voltages add up but their Ah capacity remains the same. Fig. 3.5 shows 4 pieces of 6V, 200 Ah batteries connected in series to form a battery bank of 24V with a capacity of 200 Ah. The Positive terminal of battery 4 becomes the Positive terminal of the 24V bank. The Negative terminal of battery 4 is connected to the Positive terminal of battery 3. The Negative terminal of battery 3 is connected to the Positive terminal of battery 2. The Negative terminal of battery 2 is connected to the Positive terminal of battery 1. The Negative terminal of battery 1 becomes the Negative terminal of the 24V battery bank.

SECTION 3 | Installation

3.4.2 Parallel Connection

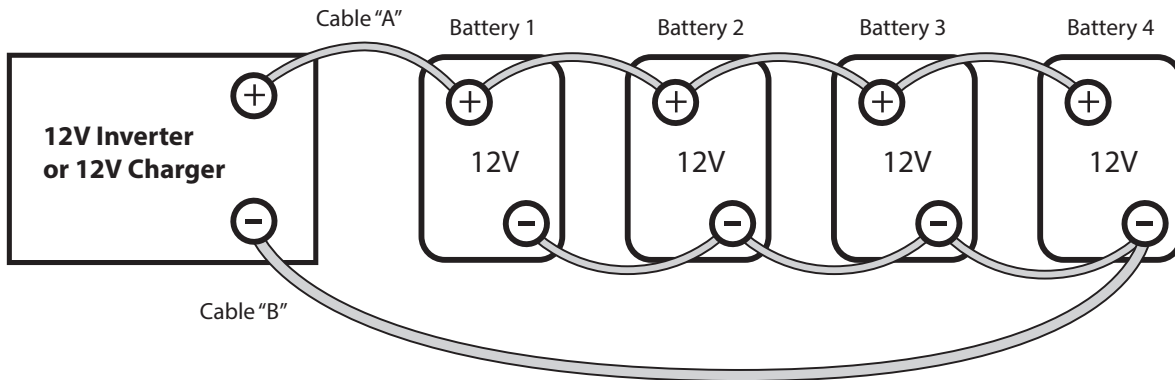

Fig 3.6 Parallel Connection

When two or more batteries are connected in parallel, their voltage remains the same but their Ah capacities add up. Fig. 3.6 above shows 4 pieces of 12V, 100 Ah batteries connected in parallel to form a battery bank of 12V with a capacity of 400 Ah. The four Positive terminals of batteries 1 to 4 are paralleled (connected together) and this common Positive connection becomes the Positive terminal of the 12V bank. Similarly, the four Negative terminals of batteries 1 to 4 are paralleled (connected together) and this common Negative connection becomes the Negative terminal of the 12V battery bank.

3.4.3 Series – Parallel Connection

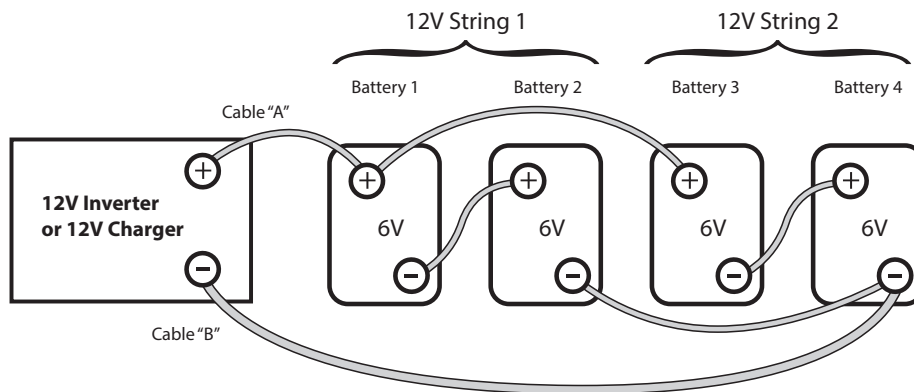

Fig. 3.7 Series-Parallel Connection

Figure 3.7 shows a series – parallel connection consisting of four 6V, 200 Ah batteries to form a 12V, 400 Ah battery bank. Two 6V, 200 Ah batteries, Batteries 1 and 2 are connected in series to form a 12V, 200 Ah battery (String 1). Similarly, two 6V, 200 Ah batteries, Batteries 3 and 4 are connected in series to form a 12V, 200 Ah battery (String 2). These two 12V, 200 Ah Strings 1 and 2 are connected in parallel to form a 12V, 400 Ah bank.

SECTION 3 | Installation

3.4.4 Wiring Order in Parallel Connection of Batteries



CAUTION!

When 2 or more batteries / battery strings are connected in parallel and are then connected to inverter/charger (See Figs 3.6 and 3.7), attention should be paid to the manner in which the inverter/charger is connected to the battery bank. Please ensure that if the Positive output cable of the inverter/charger (Cable "A") is connected to the Positive battery post of the first battery (Battery 1 in Fig 3.6) or to the Positive battery post of the first battery string (Battery 1 of String 1 in Fig. 3.7), then the Negative output cable of the inverter/charger (Cable "B") should be connected to the Negative battery post of the last battery (Battery 4 as in Fig. 3.6) or to the Negative Post of the last battery string (Battery 4 of Battery String 2 as in Fig. 3.7). This connection ensures the following:

- The resistances of the interconnecting cables will be balanced.
- All the individual batteries / battery strings will see the same series resistance.
- All the individual batteries will charge/discharge at the same charging/discharging current and thus, will be charged/discharged to the same state at the same time.
- None of the batteries will see an overcharge/overdischarge condition.

If the Positive output cable of the inverter/charger (Cable "A") is connected to the Positive battery post of the first battery (Battery 1 in Fig. 3.6) or to the Positive battery post of the first battery string (Battery 1 of String 1 in Fig. 3.7), and the Negative output cable of the inverter/charger (Cable "B") is connected to the Negative battery post of the first battery (Battery 1 as in Fig. 3.6) or to the Negative Post of the first battery string (Battery 1 of Battery String 1 as in Fig 3.7), the following abnormal conditions will result:

- The resistances of the connecting cables will not be balanced.
- The individual batteries will see different series resistances.
- All the individual batteries will be charged/discharged at different charging/discharging current and thus, will reach fully charged/discharged state at different times.
- The battery with lower series resistance will take shorter time to charge/discharge as compared to the battery which sees higher series resistance and hence, will experience over charging/over discharging and its life will be reduced.

SECTION 3 | Installation



ATTENTION!

Quand il y a 2 batteries/fils de batterie ou plus qui sont liés en parallèle et branché à la fois, à un chargeur (Voir Figs. 3.6 et 3.7), il faut faire attention à la manière dont le chargeur est branché à la banque de batterie. Veuillez assurer que le câble positif de sortie du chargeur de batterie (Câble A) est lié à la borne positive de la première batterie (La batterie 1 dans la Fig. 3.6) ou à la borne positive de batterie qui est liée au premier fil (Le fil 1 et la batterie 1, Fig 3.7), et puis le câble négatif de sortie du chargeur de batterie (Câble B) est lié à la borne négative de la dernière batterie (La Batterie 4 dans la Fig. 3.6) ou à la borne négative de batterie qui est liée au dernier fil (Le fil 2 et La batterie 4 dans la Fig. 3.7). Cette connexion assure la suivante:

- Les résistances des câbles interconnectés seront équilibrées
- Tous les batteries/ fils de batterie dans la série auront la même résistance
- Toutes les batteries individuelles vont recharger au même courant, ainsi elles seront rechargées à l'état pareille, au même temps
- Aucune des batteries auront une condition de surcharge.

Si le câble positif de sortie du chargeur de batterie (Câble A) est lié à la borne positive de la première batterie (La batterie 1 dans la Fig. 3.6) ou à la borne positive de batterie qui est liée au premier fil (Le fil 1 et La Batterie 1, Fig 3.7), et puis le câble négatif de sortie du chargeur de batterie (Câble B) est lié à la borne négative de la première batterie (La batterie 1 dans la Fig. 3.6) ou à la borne négative de batterie qui est liée au premier fil (Le fil 1 de La Batterie 1 dans la Fig. 3.7), les conditions anormales résulteront:

- Les résistances des câbles interconnectés seront pas équilibrées
- Tous les batteries/ fils de batterie dans la série n'auront pas la même résistance
- Toutes les batteries individuelles vont recharger à des courants différentes, ainsi elles atteindront un état de rechargement complet mais en décalage.
- La batterie ayant le moins de résistance dans la série prendrait moins de temps pour être rechargée comparé aux autres batteries. Alors elle serait surchargée et, en conséquence aurait une vie plus courte.

SECTION 3 | Installation

3.5 DC SIDE CONNECTIONS

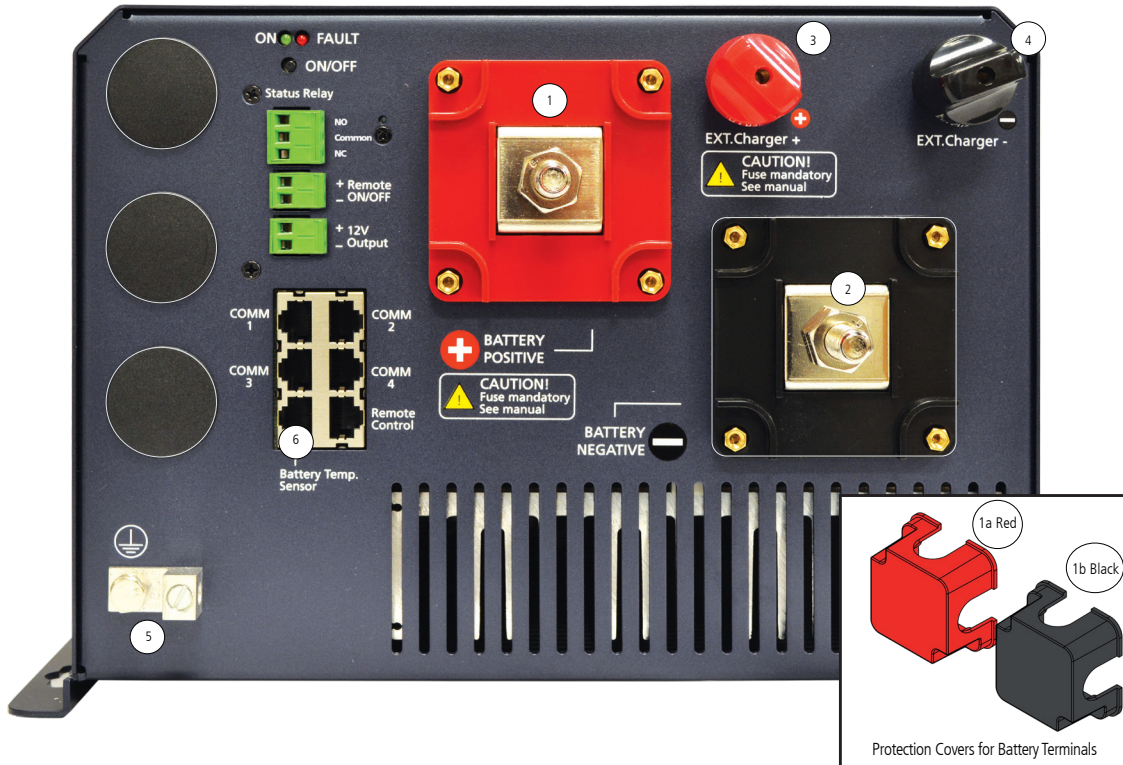

LEGEND for Fig 3.8

1. Battery Positive (+) Input Connector – Stud & Nut, M10 (Pitch 1.5 mm) (RED Protection Cover 1(a) is removed)
1a. RED Protection Cover For Battery Positive (+) Input Connector
2. Battery Negative (-) Input Connector – Stud & Nut, M10 (Pitch 1.5 mm) (Black Protection Cover 1(b) is removed)
2a. Black Protection Cover for Battery Negative (-) Input Connector
3. External Charger (+) Input Connector – Stud & Thumb Nut, M12 (Pitch 0.75 mm)
4. External Charger (-) Input Connector – Stud & Thumb Nut, M12 (Pitch 0.75 mm)
5. DC Side Grounding Connector – Hole Dia 6.5mm for up to 25mm² (AWG #4). Set Screw M-8. This is internally connected to the metal chassis of the unit
6. RJ-45 Jack for Battery Temperature Sensor EVO-BCTS

Fig 3.8 D.C Side Connections

3.5.0 Making DC Side Connections

The following DC side connections are required to be made (see Fig 3.8):

- Deep cycle batteries are connected to the battery input terminals (1) and (2). The terminals are provided with protective covers – RED for Positive and BLACK for Negative. Fit these covers once connections have been made. *For general details on sizing and charging of batteries, please refer to Section 1.4 under "General Information-Lead Acid Batteries".*
- Use appropriate external fuse (Refer to Table 3.1) within 7" of battery Positive terminal.
- External charging source, if any, is connected to the connectors (3) and (4) as shown above. **The maximum capacity of the external charging source is 50A.**
- Battery Temperature Sensor EVO-BCTS is connected to the RJ-45 Jack (6). See Fig 2.5 (a) and 2.5 (b) for details.

SECTION 3 | Installation

- DC Side Grounding Connector (5) is connected to the Earth ground / vehicle chassis ground as follows using minimum AWG #6 wire size:
 - (i) to the Bus Bar "G-B" of the DC Electrical Panel (Fig 3.12)
 - (ii) to the Bus Bar "G-B" of the Grid Electrical Panel (Fig 3.13)
 - (iii) to the RV chassis ground in RV (Figs 3.14A and 3.14B)

3.5.1 Preventing DC Input Over Voltage

It is to be ensured that the DC input voltage of this unit does not exceed 17 VDC for the 12V battery version EVO-2212 and EVO-3012, and 35 VDC for the 24V battery versions EVO-2224 and EVO-4024 to prevent permanent damage to the unit.

3.5.2 Preventing Reverse Polarity On The Input Side



CAUTION!

When making battery connections on the input side, make sure that the polarity of battery connections is correct (Connect the Positive of the battery to the Positive terminal of the unit and the Negative of the battery to the Negative terminal of the unit). If the input is connected in reverse polarity, external DC fuse in the input side will blow and may also cause permanent damage to the inverter.

Damage caused by reverse polarity is not covered by warranty.



ATTENTION!

Au moment de faire les connexions de la batterie sur le côté entrée, assurez-vous que la polarité des connexions de la batterie est correcte (Connecter la borne positive de la batterie à la borne positive de l'unité et la valeur négative de la batterie à la borne négative de l'appareil). Si l'entrée est reliée à l'inversion de polarité, DC externe fusible dans le côté d'entrée fera fondre et peut également causer des dommages permanents à l'onduleur.

Dommages causés par l'inversion de polarité n'est pas couvert par la garantie.

3.5.3 Connection From Batteries / External Charge Controller To The DC Input Side – Sizing of Cables And Fuses



WARNING!

The input section of the inverter has large value capacitors connected across the input terminals. As soon as the DC input connection loop (Battery (+) terminal → Fuse → Positive input terminal of EVO → Negative input terminal of the EVO → Battery (-) terminal) is completed, these capacitors will start charging and the unit will momentarily draw very heavy current that will produce sparking on the last contact in the input loop even when the unit is in powered down condition.

Ensure that the fuse is inserted only after all the connections in the loop have been completed so that sparking is limited to the fuse area.

SECTION 3 | Installation



MISE EN GARDE!

La section d'entrée de l'onduleur possède une grande valeur condensateurs connectés à travers les bornes d'entrée. Dès que la connexion d'entrée CC (boucle de la batterie (+) → le fusible → la borne d'entrée positive d'EVO → borne d'entrée négative de l'EVO → la batterie (-) est terminée, ces condensateurs va démarrer la charge et l'appareil se tirer momentanément actuelle très lourd qui va produire des étincelles sur le dernier contact de la boucle d'entrée même lorsque l'appareil est en état hors tension.

Assurez que le fusible est insérer seulement après que toutes les connexions sont faites dans le boucle pour que des étincelles se produisent seulement à l'endroit du fusible.

Flow of electric current in a conductor is opposed by the resistance of the conductor. The resistance of the conductor is directly proportional to the length of the conductor and inversely proportional to its cross-section (thickness). The resistance in the conductor produces undesirable effects of voltage drop and heating. The size (thickness / cross-section) of the conductors is designated by AWG (American Wire Gauge). Conductors thicker than AWG #4/0 are sized in MCM/kcmil.

Conductors are protected with insulating material rated for specific temperature e.g. 90°C/194°F. As current flow produces heat that affects insulation, there is a maximum permissible value of current (called "Ampacity") for each size of conductor based on temperature rating of its insulation. The insulating material of the cables will also be affected by the elevated operating temperature of the terminals to which these are connected. Ampacity of cables is based on UL-1741 and the National Electrical Code (NEC)-2014. Please see details given under "Notes for Table 3.1".

The DC input circuit is required to handle very large DC currents and hence, the size of the cables and connectors should be selected to ensure minimum voltage drop between the battery and the inverter. Thinner cables and loose connections will result in poor inverter performance and will produce abnormal heating leading to risk of insulation melt down and fire. Normally, the thickness of the cable should be such that the voltage drop due to the current & the resistance of the length of the cable should be less than 2%. Use oil resistant, multi-stranded copper wire cables rated at 90° C minimum. Do not use aluminum cable as it has higher resistance per unit length. Cables can be bought at a marine / welding supply store.

Effects of low voltage on common electrical loads are given below:

- **Lighting circuits - incandescent and Quartz Halogen:** A 5% voltage drop causes an approximate 10% loss in light output. This is because the bulb not only receives less power, but the cooler filament drops from white-hot towards red-hot, emitting much less visible light.
- **Lighting circuits - fluorescent:** Voltage drop causes a nearly proportional drop in light output.
- **AC induction motors** - These are commonly found in power tools, appliances, well pumps etc. They exhibit very high surge demands when starting. Significant voltage drop in these circuits may cause failure to start and possible motor damage.
- **PV battery charging circuits** - These are critical because voltage drop can cause a disproportionate loss of charge current to charge a battery. A voltage drop greater than 5% can reduce charge current to the battery by a much greater percentage.

SECTION 3 | Installation

3.5.4 Fuse Protection In The Battery Circuit

A battery is an unlimited source of current. Under short circuit conditions, a battery can supply thousands of Amperes of current. If there is a short circuit along the length of the cables that connects the battery to the inverter, thousands of Amperes of current can flow from the battery to the point of shorting and that section of the cable will become red-hot, the insulation will melt and the cable will ultimately break. This interruption of very high current will generate a hazardous, high temperature, high-energy arc with accompanying high-pressure wave that may cause fire, damage nearby objects and cause injury. To prevent occurrence of hazardous conditions under short circuit conditions, the fuse used in the battery circuit should limit the current (**should be "Current Limiting Type"**), blow in a very short time (**should be Fast Blow Type**) and at the same time, quench the arc in a safe manner. For this purpose, **UL Class T fuse or equivalent** should be used (**As per UL Standard 248-15**). This special purpose current limiting, very fast acting fuse will blow in less than 8 ms under short circuit conditions. **Appropriate capacity of the above Class T fuse or equivalent should be installed within 7" of the battery Plus (+) Terminal (Please see Table 3.1 for fuse sizing).**

Marine Rated Battery Fuses, MRBF-xxx Series made by Cooper Bussmann may also be used. These fuses comply with ISO 8820-6 for road vehicles.



WARNING!

It is mandatory to use appropriately sized external fuse in the battery and External Charger Circuits. If external fuse is not used and reverse polarity connection is made by oversight, the input section of the unit will be damaged/burnt. **Warranty will be voided in such a situation.**



MISE EN GARDE!

*Il est obligatoire d'utiliser un fusible externe de taille appropriée à la batterie et les circuits chargeur externe . Si le fusible externe est pas utilisé et les inversions de polarité est faite par la surveillance , la section d'entrée de l'unité est endommagée / brûlé . **La garantie sera annulée dans une telle situation.***

3.5.5 DC Input Connection for Battery

Battery is connected to terminals 1, 2 shown in Fig 3.8. The terminal consists of M10 Stud & Nut. Tightening torque for the nut is 70 kgf.cm (5 lbf.ft). **Sizes of cables and fuses are shown in Table 3.1.** Sizing is based on safety considerations specified in UL-1741 and NEC-2014. See details under "Notes for Table 3.1".

3.5.6 DC Input Connection for External Solar Charge Controller

External charger is connected to terminals consisting of M12 Stud with Thumb Nut (3, 4 in Fig. 5.8).

- Max current fed through these terminals should be < 50A
- Use wire size given in Table 3.1.
- Tightening torque for the Thumb Nut is 35 kgf.cm (2.5 lbf.ft)
- Use 70A fuse in series with the Positive wire to protect against short circuit along the length of the connecting wires. **Fuse should be close to the Positive Input Terminal 3.**
- Please refer to Section 5.4 for details of charging using external solar charge controller.

SECTION 3 | Installation

TABLE 3.1 SIZING OF BATTERY SIDE CABLES AND EXTERNAL BATTERY SIDE FUSES							
Item (Column 1)	Rated Continuous DC Input Current (See Note 1) (Column 2)	NEC Ampacity = 125% of Rated DC Input Current at Column 2 (See Note 2) (Column 3)	90°C Copper Conductor. Size Based on NEC Ampacity at Column (3) or 2% Voltage Drop, whichever is Thicker (See Note 3)				External Fuse Based on NEC Ampacity at Column (3) (See Note 4) (Column 9)
			Cable Running Distance between the Unit and the Battery (Cable Routing In Free Air)		Cable Running Distance between the Unit and the Battery (Cable Routing In Raceway)		
			Up to 5 ft. (Column 5)	Up to 10 ft. (Column 6)	Up to 5 ft. (Column 7)	Up to 10 ft. (Column 8)	
EVO-2212	266A	333A	AWG#3/0	AWG #4/0 (This size, based on 2% voltage drop, is thicker than NEC based size)	2 X AWG #4/0 (MCM 350)	2 X AWG #4/0 (MCM 350)	350A
EVO-2224	133A	166A	AWG #2	AWG #2	AWG #1/0	AWG #1/0	175A
EVO-3012	373A	466A	2 X AWG #3/0 (MCM 300)	2 X AWG #3/0 (MCM 300)	Not recommended	Not recommended	500A
EVO-4024	266A	333A	AWG#3/0	AWG #4/0 (2% voltage drop is thicker)	2 X AWG #4/0 (MCM 350)	2 X AWG #4/0 (MCM 350)	350A
External Charger	50A	63A	AWG #6 (2% voltage drop is thicker)	AWG #2 (2% voltage drop is thicker)	AWG #6	AWG #2 (2% voltage drop is thicker)	70A

NOTES FOR TABLE 3.1 - SIZING OF BATTERY SIDE CABLES AND EXTERNAL BATTERY SIDE FUSES

- 1) Column 2 indicates the Rated Continuous DC Input Current drawn from the battery in Inverter Mode
- 2) Column 3 indicates NEC Ampacity based on which cable conductor sizes (Columns 5 to 8) are determined. NEC Ampacity is not less than 125% of the Rated Continuous DC Input Current (Column 2) - Refer to NEC-2014 (National Electrical Code) - Section 215.2(A) (1)(a) for Feeder Circuits.
- 3) Columns 5 to 8 indicate cable conductor size that is based on the following 2 considerations. Thicker conductor out of the following 2 considerations has been chosen:
 - a) As per guidelines in NEC-2014 (National Electrical Code) - Ampacity Table 310.15(B)(16) for Raceway and Ampacity Table 310.15(B) (17) for Free Air. Conductor size is based on (i) NEC Ampacity specified at Column 3, (ii) Copper conductor with temperature rating of 90°C and (iii) Ambient temperature of 30°C / 86°F
 - b) Voltage drop across the length of cables has been limited to 2% of 12V / 24V. Voltage drop has been calculated by multiplying the Rated DC Input Current (Column 2) and the resistance of the total length of Copper conductor (the total length of conductor has been taken as 2 times the running distance between the unit and the battery to cover 2 lengths of Positive and Negative cable conductors).
- 4) Column 9 indicates the size of external fuse in the battery circuit. It is mandatory to install this fuse within 7" of the battery Positive terminal to protect the internal DC Input Section of the unit and also to protect the battery cables against short circuit. Amp rating of the fuse is based on the following considerations:
 - a) Not less than NEC Ampacity of 125% of the Rated Continuous DC Input Current (Column 3) - Refer to NEC-2014 (National Electrical Code) - Section 215.3
 - b) Closest Standard Ampere Rating of Fuse has been used - Refer to NEC-2014 (National Electrical Code) - Section 240.6(A)
 - c) Where Standard Fuse Rating does not match the required Ampacity of 125% of the Rated Continuous DC Input Current (Column 3), the next higher Standard Rating of the fuse has been used - Refer to NEC-2014 (National Electrical Code) - Section 240.4(B)
 - d) Type of fuse: Fast-acting, Current Limiting, UL Class T (UL Standard 248-15) or equivalent

SECTION 3 | Installation

3.5.7 Using Proper DC Cable Termination

The battery end and the inverter end of the wires should have proper terminal lugs that will ensure a firm and tight connection. Choose lugs to fit the wire size and the stud sizes on the inverter and battery ends.

3.5.8 Reducing RF Interference

To reduce the effect of radiated interference, shield the wires with sheathing / copper foil / braiding. For details, refer to "Limiting Electro-Magnetic Interference" at Section 1.3.4.

3.5.9 Taping Battery Wires Together To Reduce Inductance

Do not keep the battery wires far apart. Keep them taped together to reduce their inductance. Reduced inductance of the battery wires helps to reduce induced voltages. This reduces ripple in the battery wires and improves performance and efficiency. For details, refer to "Limiting Electro-Magnetic Interference" at Section 1.3.4.

3.6 AC INPUT AND OUTPUT - LAYOUT AND CONNECTION ARRANGEMENT

AC side layout and connection arrangement are shown in Fig 3.9.

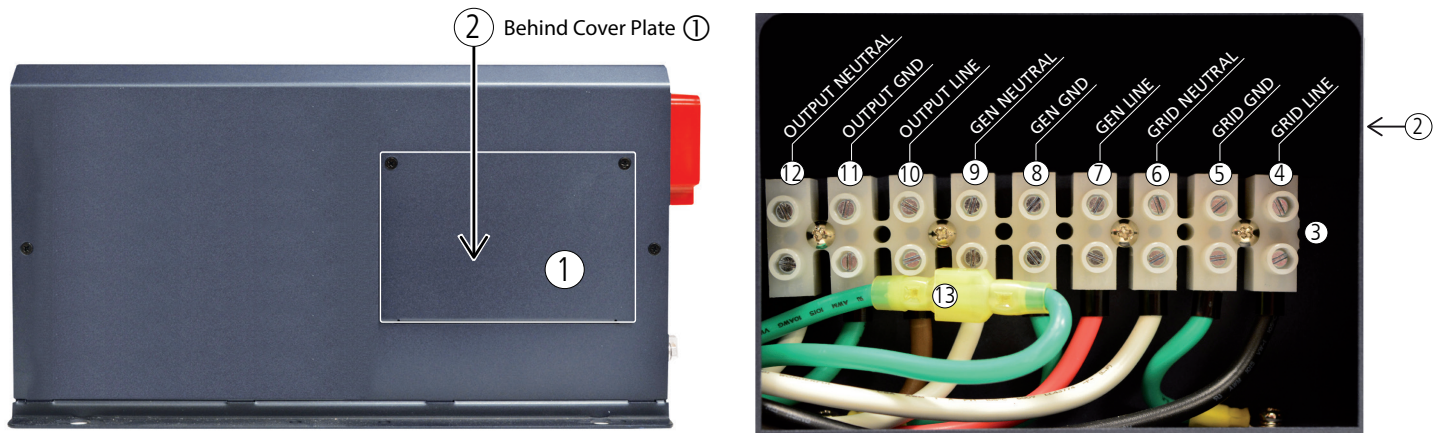

Fig 3.9 AC Input and Output

LEGEND for Fig 3.9

1. Cover plate for pocket for AC Input/Output terminals
2. Pocket for AC Input/Output Terminals (behind cover plate 1)
3. AC Input/Output Terminal Block
 - Terminal hole diameter: 6mm for up to AWG #6
 - Set Screw: M4
4. Grid Input - Line
5. Grid Input - Ground
6. Grid Input - Neutral
7. Generator Input - Line
8. Generator Input - Ground
9. Generator Input - Neutral
10. AC Output - Line
11. AC Output - Ground
12. AC Output - Neutral
13. Male/Female Insulated Quick Disconnect "QD" for disabling Output Neutral to chassis Ground bond in Inverter Mode *[Please see Section 4.5.1(c) and Fig 3.12]*

SECTION 3 | Installation

3.6.1 System Grounding and Output Neutral to Chassis Ground Bond Switching



WARNING!

- In "Inverting Mode" (default condition), the Neutral of the AC output of the unit gets bonded to the metal chassis of the unit through the internal "Neutral to Chassis Switching Relay" [Relay K4 in Figs 4.1(a) and 4.1(b)].
- In "Charging Mode", the internal "Output Neutral to Chassis Switching Relay" disconnects the Neutral of the AC output connection from the chassis of the unit. The Neutral of the AC output connection of the unit will get bonded to the Earth Ground through the Neutral to Earth Ground bond in the AC Breaker Panel/Load Center supplying Grid power / AC output connections of the generator.
- **Disabling Neutral to Ground Bond:** In some applications, the Output Neutral may be required to remain isolated from chassis/Ground at all times. For this, automatic Output Neutral to chassis Ground bond can be disabled by disconnecting the Male/Female Disconnect (13, Fig 3.9) located in the AC Wiring Compartment.
- System grounding, as required by National / Local Electrical Codes / Standards, is the responsibility of the user / system installer.

For further details please refer to Sections 4.5.1 to 4.5.3.



MISE EN GARDE!

- *En état de défaut, le neutre de la sortie CA de l'unité dans le "Mode de l'onduleur / décharge" obtient lié au châssis métallique de l'unité à travers la interne "Neutre à châssis relais de commutation".*
- *Dans "Mode de chargement", l'interne "Neutre à châssis relais de commutation" déconnecte le neutre de la connexion de sortie AC du châssis de l'unité. Le neutre de la connexion de sortie CA de l'unité va obtenir lié à la terre des masses à travers le neutre à la terre liaison au sol dans le centre de panneau de disjoncteurs AC / charge alimenter Grille / connexions de sortie CA du générateur.*
- **Désactivation du lien neutre à mise a terre:** *Dans certaines applications, il est nécessaire que la sortie neutre soit isolé du châssis/mise a terre à tout moment. Pour cela, le lien de la sortie automatique neutre au châssis/mise a terre peut être désactivé en débranchant la connexion male/femme (13 , figure 3,9) situé dans le compartiment câblage CA.*
- *Mise à la terre du système, tel que requis par la National / codes électriques locaux / normes, est de la responsabilité de l'installateur utilisateur / système.*

Pour plus de détails, veuillez vous reporter aux sections 4.5.1 à 4.5.3.

3.6.2 AC Input Considerations – Voltage And Frequency

The EVO™ unit is designed to accept 120 VAC, 60 Hz / 50 Hz single phase AC power from Grid or generator. These 120V versions come preset for 60 Hz operation. Frequency can be programmed at 50 Hz using optional Remote Control EVO-RC [See Section 4.5.2.1 of EVO-RC Remote Control Manual attached at Appendix A].

SECTION 3 | Installation

3.6.3 Preventing Paralleling of the AC Output



WARNING!

The AC output of the unit cannot be synchronized with another AC source and hence, it is not suitable for paralleling on the output side. The AC output of the unit should never be connected directly to an electrical breaker panel / load center which is also fed from another AC source. Such a connection may result in parallel operation of different power sources and AC power from the other AC source will be fed back into the unit which will instantly damage the output section of the unit and may also pose a fire and safety hazard. If an electrical breaker panel / load center is fed from this unit and this panel is also required to be powered from additional alternate AC source, the AC power from the additional AC source should first be fed to a suitable Manual/Automatic Transfer Switch and the output of the transfer switch should be connected to the electrical breaker panel / load center. To prevent possibility of paralleling and severe damage to the inverter, never use a simple jumper cable with a male plug on both ends to connect the AC output of the inverter to a handy wall receptacle in the home / RV.



MISE EN GARDE!

La sortie de courant alternatif de l'unité ne peut pas être synchronisée avec une autre source de courant alternatif et, par conséquent, il ne convient pas pour mise en parallèle du côté de la sortie. La sortie AC de l'unité ne doit jamais être connectée directement à un panneau central / de charge disjoncteur électrique qui est également alimenté par une autre source de courant alternatif. Une telle connexion peut entraîner un fonctionnement parallèle de différentes sources d'énergie et la puissance AC de l'autre source de courant alternatif est réinjecté dans l'unité qui va instantanément endommager la section de sortie de l'unité et peuvent aussi poser un risque d'incendie et de sécurité. Si un centre panneau de disjoncteur électrique / charge est alimentée à partir de cette unité et ce panneau est également nécessaire pour être alimenté à partir de suppléant supplémentaire source de courant alternatif, l'alimentation de la source de courant alternatif supplémentaire doit d'abord être introduit dans un manuel approprié / commutateur de transfert automatique et le sortie du commutateur de transfert doit être relié au centre panneau / de la charge électrique du disjoncteur. Pour éviter possibilité de mise en parallèle et de graves dommages à l'onduleur, ne jamais utiliser un câble de raccordement simple avec une fiche mâle sur les deux extrémités pour raccorder la sortie AC de l'onduleur à une prise murale à portée de main à la maison / RV.

3.6.4 Connecting to Multi-wire Branch Circuits

DO NOT directly connect the Hot side of the 120 VAC of the unit to the two Hot Legs of the 120 / 240 VAC Breaker Panel / Load Center where Multi-wire (common Neutral) Branch Circuit wiring method is used for distribution of AC power. This may lead to overloading / overheating of the Neutral conductor and is a risk of fire.

A split phase transformer (Isolated or Auto-transformer) of suitable VA rating (25 % more than the VA rating of the unit) with Primary of 120 VAC and Secondary of 120 / 240 VAC (Two 120 VAC split phases 180 degrees apart) should be used. The Hot and Neutral of the 120 VAC output of the inverter should be fed to the Primary of this transformer and the 2 Hot outputs (120 VAC split phases) and the Neutral from the Secondary of this transformer should be connected to the Electrical Breaker Panel / Load Center.

Please see details on-line under White Paper titled "120 / 240 VAC Single Split Phase System and Multi-wire Branch Circuits" at: www.samlexamerica.com (Home > Support > White Papers).

SECTION 3 | Installation

3.7 AC INPUT & OUTPUT WIRING



WARNING!

Please ensure that the AC input voltage from the Grid / Generator is connected to the AC input terminals and not to the AC output terminals and that this connection is made only when the unit is in OFF condition.

Please note that when the unit is powered on, a Self Test is carried out which includes a check if the AC input voltage from the Grid / Generator connection has been erroneously connected to the AC output terminals instead of AC input terminals. If this wrong connection is detected, (voltage > 10 VAC is seen on terminals OUTPUT LINE & OUTPUT NEUTRAL at the time of switching on of the unit), the unit will not be powered on and a message "Output Fault" will be displayed. This protection against error in connection of the AC input wiring is active only when this wrong connection is made when the unit is in OFF condition and is switched ON subsequently.

If the AC input voltage from the Grid / Generator is erroneously connected / fed to the AC output connections when the unit is ON condition, the above protection will not work and the Inverter Section will be burnt instantaneously and may become a fire hazard.



MISE EN GARDE!

Se il vous plaît faire en sorte que la tension d'entrée d'alimentation de la grille / générateur est reliée aux bornes d'entrée de courant alternatif, et non aux bornes de sortie à courant alternatif et que cette connexion est établie uniquement lorsque l'appareil est dans un état hors tension.

Se il vous plaît noter que lorsque l'appareil est sous tension, un auto-test est effectué qui inclut un contrôle si la tension d'entrée CA de la connexion réseau / générateur a été à tort connecté aux bornes de sortie CA à la place de bornes d'entrée AC. Si cette mauvaise connexion est détectée, (tension > 10 V ca se voit sur les bornes de sortie LINE et neutre de sortie au moment de la mise sous tension de l'appareil), l'unité ne sera pas allumé et un message "Sortie défaut" sera affiché. Cette protection contre les erreurs dans le cadre du câblage d'alimentation est active uniquement lorsque cette mauvaise connexion est établie lorsque l'appareil est en état hors et est allumé par la suite.

Si la tension d'entrée CA de la Grille / générateur est erronée connecté / nourri aux connexions de sortie CA lorsque l'appareil est en état, la protection ci-dessus ne fonctionnera pas et la Section de l'onduleur sera brûlé instantanément et peut devenir un risque d'incendie.

3.7.1 AC Input/Output Supply Connections

The AC input and output supply connections are located in a pocket protected by a cover with a removable front plate (1,2 Fig 3.9). Three 27.8mm / 1^{3/32}" diameter holes (10A to 10C, Fig 2.1) have been provided for cable / conduit entry. Remove the caps covering the holes and install appropriate 3/4" Trade Size Fitting for routing the AC input and output wires/conduits.

SECTION 3 | Installation

Screw down type of terminal block (3, Fig 3.9) is used for connecting the wires. The hole size for wire entry is 6 mm and set screw size is M4. It can accommodate conductors with solid or multi-stranded wire size range of AWG #6 to AWG #20.

Strip adequate insulation from the end of the wire (Fig. 3.11). Avoid nicking the wire when stripping the insulation. Wire End Terminals have been provided (see Section 2.6, page 28) for firm connection under the set screw. Insert the bare end of the wire into the barrel portion of the Wire End Terminal & crimp barrel portion using suitable crimping tool (Fig 3.11).

Insert the terminated end of the wire fully into the terminal slot till it stops. Tighten the screw firmly. Tightening torque for the screws – 7 to 12 Kgf*cm / 0.5 to 0.9 lbf*ft.

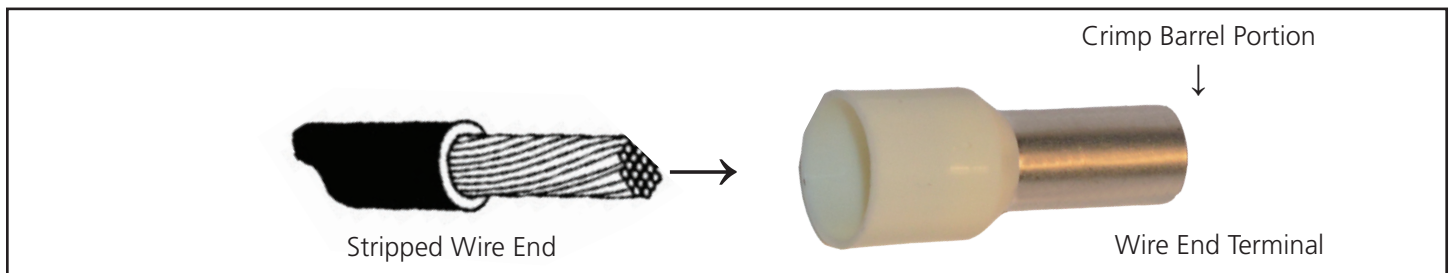

Fig 3.11 Stripped Wire End Terminal on AC Wiring

3.7.2 Tightening Torques

Tightening torques to be applied to the wiring terminals are given in Table below:

TIGHTENING TORQUES		
Battery Input Connectors	External Charger Input Connectors	AC Input and Output Connectors
70 kgf.cm (5.0 lbf.ft)	35 kgf.cm (2.5 lbf.ft)	7 to 12 kgf.cm (0.5 to 0.9 lbf.ft)

3.8 SIZING OF WIRING AND BREAKERS - AC INPUT SIDE



WARNING!

AC Breakers for the AC input circuits have NOT been provided internally. These have to be provided externally by the installer / user based on guidelines given below. Please note that guidelines given below on wire sizing and over-current protection will be superseded by the applicable National / Local Electrical Codes.



MISE EN GARDE!

Breakers AC pour les circuits d'entrée AC ont pas été fournis en interne. Ceux-ci doivent être fournies à l'extérieur par l'installateur / utilisateur sur la base des directives données ci-dessous. Se il vous plaît noter que les directives ci-dessous sur dimensionnement des câbles et protection contre les surintensités seront remplacées par les nationaux / codes électriques locaux applicables.

SECTION 3 | Installation

3.8.1 Table for Wire and Breaker Sizing - AC Input Side

Table 3.2 provides details of wire and breaker sizing for the AC input side.

AC input side wiring and breaker sizes depend upon the maximum continuous AC input current under various operating conditions described in the succeeding paragraphs.

- The Maximum Load Current on the output side has to be limited to the rated output Amp capacity of the specific model when operating in Inverter Mode (Column 1).
- When Grid / Generator input is available and the unit is operating in Charging / Pass Through Mode, the AC Input Current will be determined as follows:
 - The maximum possible AC Input Current (Column 4) for a particular model will be equal to the sum of the Rated AC Side Battery Charging Current (Column 3) and the Rated Pass Through current (Column 2). Rated Pass Through Current (Column 2) = the Rated Output Current in Inverter Mode (Column 1).
 - The AC Input current in Charging / Pass Through Mode will be restricted by the maximum Amp rating of the Generator or the Amp rating of the breaker in the Grid Branch Circuit that is feeding the unit. The AC Input Current drawn by the unit can be programmed to the desired limit (Column 4) to match the output Amp rating of the Generator or the Amp rating of breaker in the Grid Branch Circuit. Optional Remote Control EVO-RC is required to change this limit (See Appendix A, Section 4.5.2.2 for Input Settings - "GRID MAX CURRENT" / "GEN MAX CURRENT"). All the 4 models EVO-2212, 2224, 3012 and 4024 come with the "GRID MAX CURRENT" / "GEN MAX CURRENT" set at 30A (Default Setting).
 - Higher Power Models will require higher Amp rating of the Generator / the Grid Branch Circuit. Wiring and breaker sizing for the full rated AC input currents for EVO-2212, 2224, 3012 and 4024 are given at Table 3.2.

TABLE 3.2 SIZING OF GRID AND GENERATOR INPUT WIRING AND BREAKERS						
Model No. (Rated Output Power in Inverter Mode)	Rated AC Pass Through Current (See Note 2)	Rated AC Side Charging Current (See Note 3)	Total Rated AC Input Current (Columns 2 +3) (See Note 4)	NEC Ampacity = 125% of Column 5 (See Note 5)	Conductor Size Based on NEC Ampacity at Column 6 (See Note 6)	External Breaker Size Based on NEC Ampacity at Column 6 (See Note 7)
(Column 1)	(Column 2)	(Column 3)	(Column 4)	(Column 5)	(Column 6)	(Column 7)
EVO-2212 (2200VA, 18A)	18 A	15A	33A	41.25A	AWG #8	45A
EVO-2224 (2200VA, 18A)	18A	19A	37A	46.25A	AWG #8	50A
EVO-3012 (3000VA, 25A)	25A	20A	45A	56.25A	AWG #6	60A
EVO-4024 (4000VA, 33A)	33A	30A	63A	78.75A	AWG #4 or 2X AWG #6	80A

NOTES FOR TABLE 3.2 - SIZING OF GRID AND GENERATOR INPUT WIRING AND BREAKERS

- 1) Column 1 indicates the Model No and rated output power (VA) and current (A) in Inverter Mode.
- 2) Column 2 indicates the Rated AC Pass Through Current when in Charger / Pass Through Mode (value of this current = Rated AC Output Current in Inverter Mode).

SECTION 3 | Installation

- 3) Column 3 indicates the Rated AC Side Charging Current in Charger / Pass Through Mode (see rating called "Rated Continuous AC Input Current" under INTERNAL BATTERY CHARGER SECTION of Specifications at Section 7.
- 4) Column 4 indicates the total Rated AC Input Current which is the sum of the Rated AC Pass Through Current (Column 2) and the Rated AC Side Charging Current (Column 3).
- 5) Column 5 indicates NEC Ampacity based on which the wiring conductor size (Column 6) is determined. This NEC Ampacity is not less than 125% of the AC Input Current Limit (Column 4) - Refer to NEC-2014 (National Electrical Code) - Section 210.19(A)(1)(a) regarding minimum Ampacity and size of Branch Circuit Conductors.
- 6) Column 6 indicates the wiring conductor size that has been determined based on NEC-2014 (National Electrical Code) - Ampacity Table 310.15(B)(16) for Raceway. This conductor size is based on (i) NEC Ampacity (Column 6) (ii) conductor temperature of 75°C / 167°F and (iii) ambient temperature of 30°C / 86°F.
- 7) Column 7 indicates the Amp rating of EXTERNAL breaker that is required to be installed in the Load Center / Breaker Panel feeding the unit. The Amp rating of this breaker is based on the following considerations:
 - a. Not less than the NEC Ampacity (Column 5) - Refer to NEC-2014 (National Electrical Code) - Section 210.20(A) regarding overcurrent protection of Branch Circuit Conductors. However, the Amp rating of the fuse has to be \leq the Ampacity of wire size at Column 7 based on Table 310.15(B)(16) for Raceway (conductor temperature of 75°C / 167°F and ambient temperature of 30°C / 86°F).
 - b. Closest Standard Ampere Rating of Breaker has been used - Refer to NEC-2014 (National Electrical Code) - Section 240.6(A) regarding overcurrent protection
 - c. Where Standard Breaker Rating does not match the required NEC Ampacity (Column 6), the next higher Standard Rating of the breaker has been used - Refer to NEC-2014 (National Electrical Code) - Section 240.4(B) regarding over current devices
 - d. Type of breaker: Standard circuit breaker for 120VAC Load Center /Breaker Panel

3.9 SIZING OF WIRING AND BREAKERS - AC OUTPUT SIDE



WARNING!

AC Breakers for the AC output circuits have NOT been provided internally. These have to be provided externally by the installer / user based on guidelines given below. Please note that guidelines given below on wire sizing and over-current protection will be superseded by the applicable National / Local Electrical Codes.



MISE EN GARDE!

Breakers AC pour les circuits d'entrée AC ont pas été fournis en interne. Ceux-ci doivent être fournies à l'extérieur par l'installateur / utilisateur sur la base des directives données ci-dessous. Se il vous plaît noter que les directives ci-dessous sur dimensionnement des câbles et protection contre les surintensités seront remplacées par les nationaux / codes électriques locaux applicables.

SECTION 3 | Installation

3.9.1 Tables for Wire and Breaker Sizing - AC Output Side

Table 3.3 provides details of wire and breaker sizing for the AC output side.

AC wiring and breaker sizes on the AC output side are required to be determined by the Rated Load Current when operating in Inverter Mode (Column 2).

TABLE 3.3 SIZING OF AC OUTPUT WIRING AND BREAKERS				
Model No. and Rated Output Power in Inverter Mode	Rated AC Output Current in Inverter Mode	NEC Ampacity = 125% of Column 2	Conductor Size based on NEC Ampacity at Column 3	External Breaker Size based on NEC Ampacity at Column 3
(Column 1)	(Column 2)	(Column 3)	(Column 4)	(Column 5)
EVO-2212 (2200VA)	18A	22.5A	AWG #10	25A
EVO-2224 (2200VA)	18A	22.5A	AWG #10	25A
EVO-3012 (3000VA)	25A	31.25A	AWG #8	35A
EVO-4024 (4000VA)	33A	41.25A	AWG #8	45A

NOTES FOR TABLE 3.3 - AC OUTPUT WIRING AND BREAKERS

- 1) Column 1 indicates Model No and Output Power (VA)
- 2) Column 2 indicates the Rated AC Output Current in Inverter Mode
- 3) Column 3 indicates NEC Ampacity based on which the output-wiring conductor is sized. This NEC Ampacity is not less than 125% of the Rated Output Current in Inverter Mode (Column 2). - Refer to NEC-2014 (National Electrical Code) - Section 215.2(A)(1)(a) regarding Feeder Circuit Conductors. PLEASE NOTE that when the unit is operating in Inverter Mode, it is considered to be an AC source that is feeding power to the Load Center / Breaker Panel on the load side. Hence, the AC output circuit of the unit is considered to be a Feeder Circuit for purposes of NEC-2014.
- 4) Column 4 indicates conductor size for the output side wiring. The size is based on NEC-2014 (National Electrical Code) - Ampacity Table 310.15(B)(16) for Raceway. Conductor size is based on (i) NEC Ampacity (Column 3), (ii) conductor temperature of 75°C and (iii) ambient temperature of 30°C / 86°F.
- 5) Column 5 indicates the Amp rating of EXTERNAL breaker that is required to be installed in the Load Center / Breaker Panel that is being fed from the AC output from this unit. Amp rating of the breaker is based on the following considerations:
 - a) Not less than NEC Ampacity (Column 3) - Refer to NEC-2014 (National Electrical Code) - Section 215.3 regarding over-current protection of Feeder Circuit Conductors.
 - b) Closest Standard Ampere Rating of Breaker has been used - Refer to NEC-2014 (National Electrical Code) - Section 240.6(A) regarding Standard Ampere Ratings.
 - c) Where Standard Breaker Rating does not match the required NEC Ampacity at Column 3, the next higher Standard Ampere Rating of the breaker has been used - Refer to NEC-2014 (National Electrical Code) - Section 240.4(B) regarding over current devices rated 800 Amps or less.
 - d) Type of breaker: Standard circuit breaker for 120VAC Load Center /Breaker Panel

SECTION 3 | Installation

3.10 GFCI PROTECTION FOR VEHICLE APPLICATION

When this unit is installed in vehicles, ensure that Ground Fault Circuit Interrupter(s) are installed in the vehicle wiring system to protect all branch circuits. Details of tested and approved GFCI's are given in Table 1.1.5.

3.11 GROUNDING TO EARTH OR TO OTHER DESIGNATED GROUND

i INFO

Please read following on-line White Papers for complete understanding of Grounding at www.samlexamerica.com (Home > Support > White Papers):

- **"Grounded Electrical Power Distribution"**
- **"Grounding System and Lightning / Ground Fault Protection"**

Grounding means connecting (bonding) to Earth Ground or to the other designated Ground. For example, in a motorhome / caravan, the metal frame of the motorhome / caravan is normally designated as the Negative DC Ground / RV Ground. Similarly, all metal portions of boats and marine craft are bonded together and called Boat Ground.

Grounding is required for (i) protection against damage due to lightning strike and (ii) protection against electric shock due to "Ground Fault". In case of EVO, "Ground Fault" may occur due to inadvertent contact between an energized ungrounded current carrying conductor and exposed metal surface resulting in voltage getting fed to (i) the metal chassis of the EVO™ or (ii) to the metal chassis of the devices connected to EVO™ or (iii) to the metal frame/ chassis in an RV / motorhome / caravan. When this energized exposed surface is touched, the voltage will drive current through the body to Earth Ground producing electric shock. When properly grounded to Earth Ground (or Frame / Chassis Ground in motorhome or caravan), the Leakage Current Protection Device (like RCD, GFCI etc.) or Over Current Protection Device (like Circuit Breaker or Fuse) will trip and interrupt the circuit feeding power from the AC source (EVO™ / Grid / Generator) or the DC source (12V / 24V battery). Proper grounding will ensure that all exposed metal surfaces will have equal potential and will be bonded to (i) a single common Earth Ground point i.e. the Ground Rod / buried metallic water / gas pipe at the premises or (ii) the Frame / Chassis Ground in a motorhome / caravan.

3.12 GROUNDING ARRANGEMENT IN EVO SERIES

Schematic at Fig. 3.12 illustrates the grounding arrangement of EVO Series.

Internally, EVO™ consists of a DC Section and an AC Section that are isolated through a transformer. Both these sections are required to be grounded appropriately.

When using a generator, please ensure that (i) the Neutral of the generator is NOT bonded to the metal frame of the generator and (ii) the metal frame of the generator is bonded to Earth Ground through the Grounding Electrode (GE) i.e. the Ground Rod.

SECTION 3 | Installation

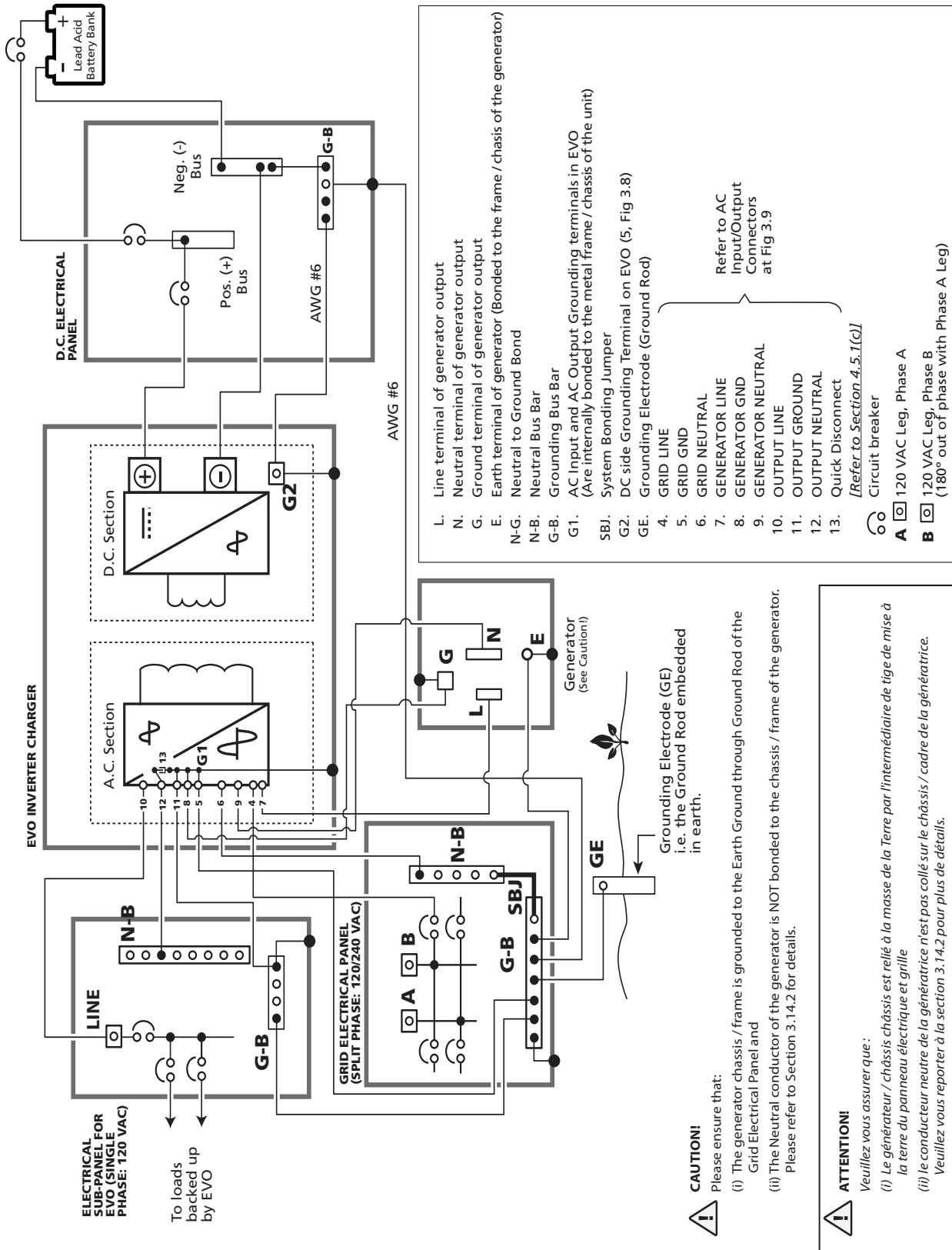

Fig 3.12 Grounding Arrangement for Shore Based Installation

SECTION 3 | Installation

3.13 DC SIDE GROUNDING (SEE FIG. 3.12)

DC side grounding involves bonding of the metal frame/chassis of EVO™, the metal chassis of the DC Electrical Panel and the Battery Negative Terminal to Earth Ground in shore based installation or to the metal frame / "Chassis" of the motorhome / caravan. This ensures that in case of a ground fault in the +12V / +24V circuit, the fuse in the +Battery line blows to clear the fault. This fuse in the +Battery line has Ampere capacity matching the rated DC input current of the EVO™ in Inverter Mode. The wire size used for DC side grounding should be minimum AWG #6 or of the same size as the battery cable, whichever is thicker (Battery cable size should have minimum Ampacity ≥ the Ampere rating of this battery fuse depending upon the model of the EVO being used).

This recommendation on sizing of the DC Side Grounding Wire will be superseded by the National / Local Electrical Codes.



CAUTION!

As per American Boat and Yacht Council (ABYC) Standard E-11 for AC and DC Electrical Systems on Boats, the size of DC side grounding wire shall not be smaller than one size under that required for current carrying conductors supplying the device. Hence, for application on EVO™ on boat / yacht, the size of the DC side grounding conductor should be of the same or one size smaller than the size of battery cable specified in Table 3.1.



ATTENTION!

Selon le « American Boat and Yacht Council » (ABYC) la norme E-11 pour le système électrique CA et CC des bateaux, la taille du fil de mise à la terre du côté CC ne doit pas être inférieure à un format sous celle requise pour les conducteurs tenant le courant pour alimenter l'appareil. Par conséquent, pour l'application EVO sur le bateau / yacht, la taille du conducteur de mise a terre côté CC devrait être de la même ou strictement une taille plus petite que la taille du câble de batterie indiqué dans le tableau 3.1.



INFO

As described at Section 3.14, the metal frame / chassis of the EVO™ (Fig 3.12, G1) is bonded to the Earth Ground "GE" (Ground Rod) for AC side grounding. It may be argued that if the metal frame / chassis of EVO is already bonded to Main Earth Ground "GE" for AC side grounding, why it is necessary to provide additional DC side grounding wiring? (Wiring that bonds DC Grounding Terminals "G2", "G-B" and GE in Fig 3.12). If separate thicker grounding wire of the same size as the battery cable was not provided for the DC side grounding and there was a ground fault in the battery circuit, very large DC fault current from Battery+ would flow through the smaller size AC grounding wires to the Battery Negative through Earth Ground. These smaller size AC side grounding wires would be damaged due to very high DC side fault current (150A to 400A depending on the Model of the EVO™ being used).

A DC Side Grounding Connector (G2) (5 in the DC side layout in Figs 2.1/3.8) is provided for connecting to the System Ground. The connector can accept wire sizes AWG # 4–6. The set screw size is M8.

SECTION 3 | Installation

A DC Distribution Panel, as shown in Fig. 3.12, is normally provided to connect the batteries and distribute DC power to the inverter and to the other DC loads.

The Negative of the battery is connected to the Neg (-) Bus of the DC Electrical Panel which, in turn, is connected to its Grounding Bus Bar (G-B). Grounding Bus Bar G-B of the DC Electrical Panel is further bonded to the Grounding Bus Bar "G-B" of the Grid Electrical Panel and then to the Grounding Electrode (GE), also called Ground Rod. Hence, the Battery Negative, the chassis of the DC Electrical Panel and the metal chassis of the EVO™ will all be bonded to the Earth Ground.

Connect the DC Grounding Terminal (G2) (5 in the DC side layout in Fig. 3.8), to the Grounding Bus Bar (G-B) in the DC Electrical Panel using AWG #6 insulated stranded copper wire. Similarly, use AWG #6 wire to connect the Grounding Bus Bar "G-B" in the DC Electrical Panel to the Grounding Bus Bar "G-B" in the Grid Electrical Panel. For application of EVO™ on a boat, the size of this wire should be of the same size or one size smaller than the battery Negative wire (See CAUTION! above).

The connections must be tight against bare metal. Use star washers to penetrate paint and corrosion. **As the Equipment Grounding Bus Bar ("G-B") in the DC Electrical Panel is bonded to the Grounding Electrode (GE) through Grounding Bus Bar "G-B" in the Grid Electrical Panel, the metal chassis of the EVO™ will be bonded to Earth Ground for protection against Ground fault on the DC side of EVO™.**

3.14.1 AC Side Grounding

Please refer to Fig 3.12.

- In EVO™, the AC Input Grounding Terminals {GEN GND (8), GRID GND (5)} and AC Output Grounding Terminals {OUTPUT GND (11)}, are internally bonded to the metal chassis of the inverter (G1)
- The Grounding Wires from Grid/Generator are connected to the AC input Ground terminals in EVO™ {GRID GND (5), GEN GND (8)}.
- The AC output Ground wire of EVO™ {OUTPUT GND (11)} is connected to the Grounding Bus Bar (G-B) of the Electrical Sub-Panel for EVO.
- The Grounding Bus Bar (G-B) of the Electrical Sub-Panel for EVO is connected to the Grounding Bus Bar (G-B) of the Grid Electrical Panel.
- The Earth Terminal (E) of the Generator (bonded to the frame / chassis of the Generator) is also connected to the Grounding Bus Bar (G-B) of the Grid Electrical Panel.
- The Grounding Bus Bar (G-B) of the Grid Electrical Panel is bonded to the Grounding Electrode (GE) i.e. the Ground Rod.
- **Thus, in keeping with the NEC requirements, the AC Grounds of EVO™, Grid Electrical Panel and the Generator will be bonded to the Earth Ground only at one single point at the Grid Electrical Panel feeding the EVO™.**

3.14.2 Grounding Requirements Of External Generator

As explained at Section 3.14.1 above and shown in Figs 3.12 and 3.14, the Neutral Terminals of Grid Input, Generator Input and AC Output are internally bonded to the metal chassis of the EVO™ and the metal chassis of the EVO™ is connected to the Earth Ground through the Ground Rod of the Grid Electrical Panel. As the internal Transfer Relay does NOT transfer the Neutral of the Grid and Generator Inputs, the Neutral Terminal of

SECTION 3 | Installation

the external Generator will get solidly connected to the Neutral of the Grid Service Neutral. With this type of Neutral connections, the external Generator will NOT be considered as a Separately Derived System as per FPN 1 in Section 250.20(D) of NEC 2011 and hence, the Neutral conductor of the external Generator is NOT required to be grounded to Earth Ground through Ground Rod as per Section 250.30 of NEC 2011.

Small portable generators supplied with receptacles will often have the Neutral conductor bonded to the generator frame. **If the generator frame gets grounded to Earth Ground, then the generator can only be used with a Transfer Switch that transfers the Neutral.**

Larger generators typically do not have the Neutral grounded to the frame.



CAUTION!

When connecting a generator to the EVO™ for shore based installation (See Figs 3.12 and 3.14), please ensure that (i) the generator chassis / frame is grounded to the Earth Ground through Ground Rod of the Grid Electrical Panel and (ii) the Neutral conductor of the generator is NOT bonded to the chassis / frame of the generator. If the bond between the Neutral conductor of the generator and it's chassis / frame is not removed, GFCI protected breaker supplying Grid power to the EVO™ will trip due to splitting of some return Neutral current through the path: Common Neutral → Neutral of Generator → Neutral to chassis / frame bond in the Generator → Neutral to Ground bond in Grid Electrical Panel → Neutral of Grid Electrical Panel (current returning through this path will not return through the GFCI protected Grid breaker and the GFCI will trip the breaker).



ATTENTION!

Lors de la connexion d'un générateur à l'EVO pour l'installation à partir du rivage (voir les figures 3.12 et 3.13), veuillez vous assurer que (i) le générateur / châssis est relié à la masse de la Terre par l'intermédiaire de tige de mise à la terre de la grille panneau électrique et (ii) le conducteur neutre de la génératrice n'est pas collé sur le châssis / cadre de la génératrice. Si la liaison entre le conducteur neutre de l'alternateur et c'est châssis / trame n'est pas enlevé, protégée GFCI breaker fournissant l'alimentation de la grille de l'EVO s voyage en raison d'un fractionnement de revenir par le chemin courant: Neutre commun → Générateur de Point Mort pour châssis / liaison châssis dans le générateur → point mort à la masse du panneau électrique grille → Point Mort du panneau électrique de la grille actuelle (retour par ce chemin ne sera pas de retour à travers la grille de protection GFCI disjoncteur et le disjoncteur se déclenche le disjoncteur).

3.14.3 Switching Of Bonding Of Output Neutral To Chassis Ground

As required by NEC and UL Standard 458, automatic switching of bonding between the Output Neutral and Chassis Ground has been provided in EVO™ through "Output Neutral and Chassis Ground Bond Switching Relay" [K4 in Figs 4.1(a) and 4.1(b)]. Switching is carried as follows:

- When operating as an inverter, the current carrying conductor of the Inverter Section that is connected to the Output Neutral terminal of the EVO™ is bonded to the metal chassis of EVO by the "Output Neutral to Chassis Ground Bond Switching Relay" [K4 in Figs 4.1(a) and 4.1(b)]. As the metal chassis of EVO is in turn bonded to the Earth Ground (in shore installations) or RV Ground (chassis of the RV) or to the Boat Ground (DC Negative

SECTION 3 | Installation

Grounding Bus Bar and the Main AC Grounding Bus Bar are tied together in a boat and this is called the “Boat Ground”), this current carrying conductor of the Inverter Section (connected to the Output Neutral Terminal) will become the Grounded Conductor (GC) or the Neutral of the Inverter Section.

- When in Charging Mode, the Neutral conductor of the Grid power/Generator will be connected to the Output Neutral terminal of EVO™. At the same time, the “Output Neutral to Chassis Ground Bond Switching Relay” [K4 in Figs 4.1(a) and 4.1(b)] will unbond (disconnect) the Output Neutral connector of EVO™ from the metal chassis of EVO™. This will ensure that the Grounded Conductor (GC) i.e. the Neutral of the Grid power/Generator is bonded to the Earth Ground at one single point at the location of the AC Power Distribution System of the Marina / RV Park / Shore Power.
- **Disabling Neutral to Ground Bond:** In some applications, the Output Neutral of EVO™ may be required to remain isolated from the chassis/Ground at all times. For this, automatic Output Neutral to Chassis Ground bond can be disabled by disconnecting the Male/Female Quick Disconnect located in the AC wiring compartment. [Please see (i) 13, Fig 3.9 and (ii) “QD” in Figs 4.1(a) and 4.1(b)].

Please read the following on-line White Papers for more details at www.samlexamerica.com (Home > Support > White Papers):

- **“Neutral to Ground Switching in RV and Marine Applications**

3.15 BATTERY TEMPERATURE SENSOR: MODEL NO. EVO-BCTS

3.15.1 Temperature Compensation of Battery Charging Voltages

Please refer to Section 5.5 for detailed information on temperature compensation of battery charging voltages using Battery Temperature Sensor EVO-BCTS.

3.15.2 Constructional Details and Installation

The Temperature Sensor consists of 5 meters / 16.5 ft cable with Temperature Sensor Head for the battery end [1 in Fig 2.5(a)] and RJ-45 Plug [2 in Fig 2.5(b)] for EVO™ end.

Temperature Sensor Head [1 in Fig 2.5(a)]: The Temperature Sensor Head is installed on the Positive / Negative battery Stud [Fig 2.5(b)] to monitor the temperature of the battery electrolyte. The Sensor Head contains an embedded Negative Temperature Coefficient (NTC) Resistor with 2 internal terminals “NTC+” and “NTC -”. Internal terminal “NTC+” is wired to Pin 4 of the RJ-45 Plug [2 in Fig 2.5(b)] and internal terminal “NTC -” is wired to Pin 5 of the RJ-45 Plug.

RJ-45 Plug [2 in Fig 2.5(b)]: The RJ-45 Plug is required to be plugged into the RJ-45 Jack marked “Battery Temp Sensor” on the front panel of EVO™ (6 in Fig 2.1). Pinout of the RJ-45 jack is shown in Fig 3.13.

RJ-45 Jack on The Front Panel of EVO™ (6, Fig 2.1) for Connecting Battery Temperature Sensor.

Pinout of this RJ-45 Jack [marked “Battery Temp Sensor” on the front panel of EVO™ (6 in Fig 2.1)] is shown at Fig 3.13 below:

SECTION 3 | Installation

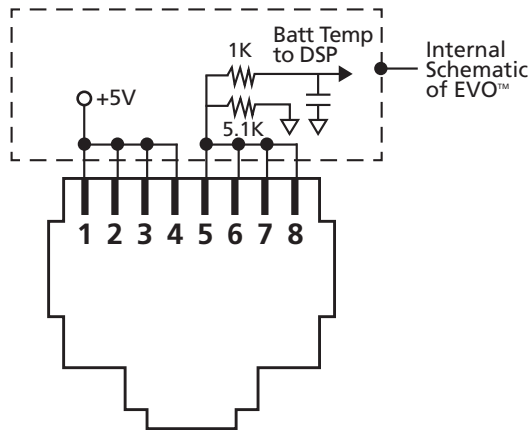

Fig 3.13 Pinout of RJ-45 Jack marked “Battery Temp Sensor” on the front panel of EVO™ (6 in Fig 2.1).

3.16 INSTALLING CONTROL INPUT WIRING FROM LITHIUM BATTERY MANAGEMENT SYSTEM (BMS) TO ENABLE / DISABLE CHARGING OR INVERTING

Refer to Section 5.11.2 regarding “**Stop Charging**” or “**Stop Inverting**” protections for Lithium Ion Batteries when parameter “BATTERY TYPE” is programmed for Option 2 - “1=Lithium” (See programming details at Section 4.4.2.22.2 in the EVO-RC Manual attached at Appendix A)

The Battery Charger Section of EVO is designed to charge 3 types of batteries - Lead Acid / Nickel Zinc (Ni-Zn) / Lithium Ion. Lead Acid and Nickel Zinc (Ni-Zn) battery charging voltages are required to be compensated based on the temperature of the battery cells. Hence, Battery Temperature Sensor Model EVO-BCTS is required to be connected to the RJ-45 Jack (6, Fig 2.1) as explained at Section 3.15.

Charging voltages of Lithium Ion Battery are not affected by temperature and hence, Battery Temperature Sensor Model EVO-BCTS is NOT required to be used when Lithium Ion batteries are used. The RJ-45 Jack (6, Fig 2.1) can be used to feed control signals from certain Lithium Ion Battery Management Systems (BMS) that may have capability of enabling / disabling “**Stop Charging**” or “**Stop Inverting**” control signals for inverter chargers. This control signal is normally generated by the BMS by switching ON (enabling) or switching OFF (disabling) potential free, Drain (+) and Source (-) terminals of mini Opto Isolated Mosfet Switch [Solid-State Relay (SSR)]. Connect the control signal output from the BMS to RJ-45 Jack (6, Fig 2.1) as follows:

- **BMS control signal terminal marked “+”:**
 - Connect to any of Pins 1/2/3/4 (Refer to Fig 3.13 for pinout of RJ-45 Jack. Pins 1 to 4 are internally shorted)
- **BMS control signal terminal marked “-”:**
 - Connect to any of Pins 5/6/7/8 (Refer to Fig 3.13 for pinout of RJ-45 Jack. Pins 5 to 8 internally shorted)

SECTION 3 | Installation

3.17 SHORE BASED INSTALLATION

3.17.1 Typical Shore Based Installation

Fig. 3.14 illustrates a typical shore based installation

- Battery is connected to the DC input connections through DC Electrical Panel with an appropriate fuse to protect the DC input cables against short circuit
- Battery Temperature Sensor Model EVO-BCTS is installed on the Positive or Negative post of the battery and connected to the RJ-45 Jack for the Temperature Sensor
- Supplementary battery charging is being carried out through a solar array and a Charge Controller connected to the DC input provided for external charge controller
- AC input to the EVO™ is fed from the Grid Panel
- AC output from the EVO™ is fed to the AC Electrical Sub-Panel for EVO™
- Automatic Generator start/stop is possible. Please see Section 4.7 for details



CAUTION!

When using generator, please ensure the following:

- Neutral of the generator is **NOT** bonded to the chassis of the generator and its chassis /frame is bonded to the Earth Ground (Ground Rod "GE").
- If the Generator is a 120VAC / 240VAC Split Single Phase with 120 VAC phase fed to the EVO™, then both 120VAC Split Phases of the generator should be equally loaded (balanced) to prevent deterioration of regulation of generator's output voltage. Poor regulation of generator output voltage may lead to interruption of charging / AC pass through in the EVO™.



ATTENTION!

Lorsque vous utilisez le générateur, vérifiez les points suivants :

- *Neutre le générateur n'est pas collé sur le châssis du générateur et le châssis / est collé à la terre (masse tige "GE").*
- *Si le générateur est a 120VCA / 240VCA Phase unique fendue avec phase 120VCA nourri à l'EVO, puis les deux 120VCA Split Phases du générateur devrait être également chargé (équilibré) pour prévenir la détérioration du règlement de tension de sortie du générateur. Une mauvaise régulation de tension de sortie du générateur peut entraîner l'interruption de la charge à l'EVO.*

SECTION 3 | Installation

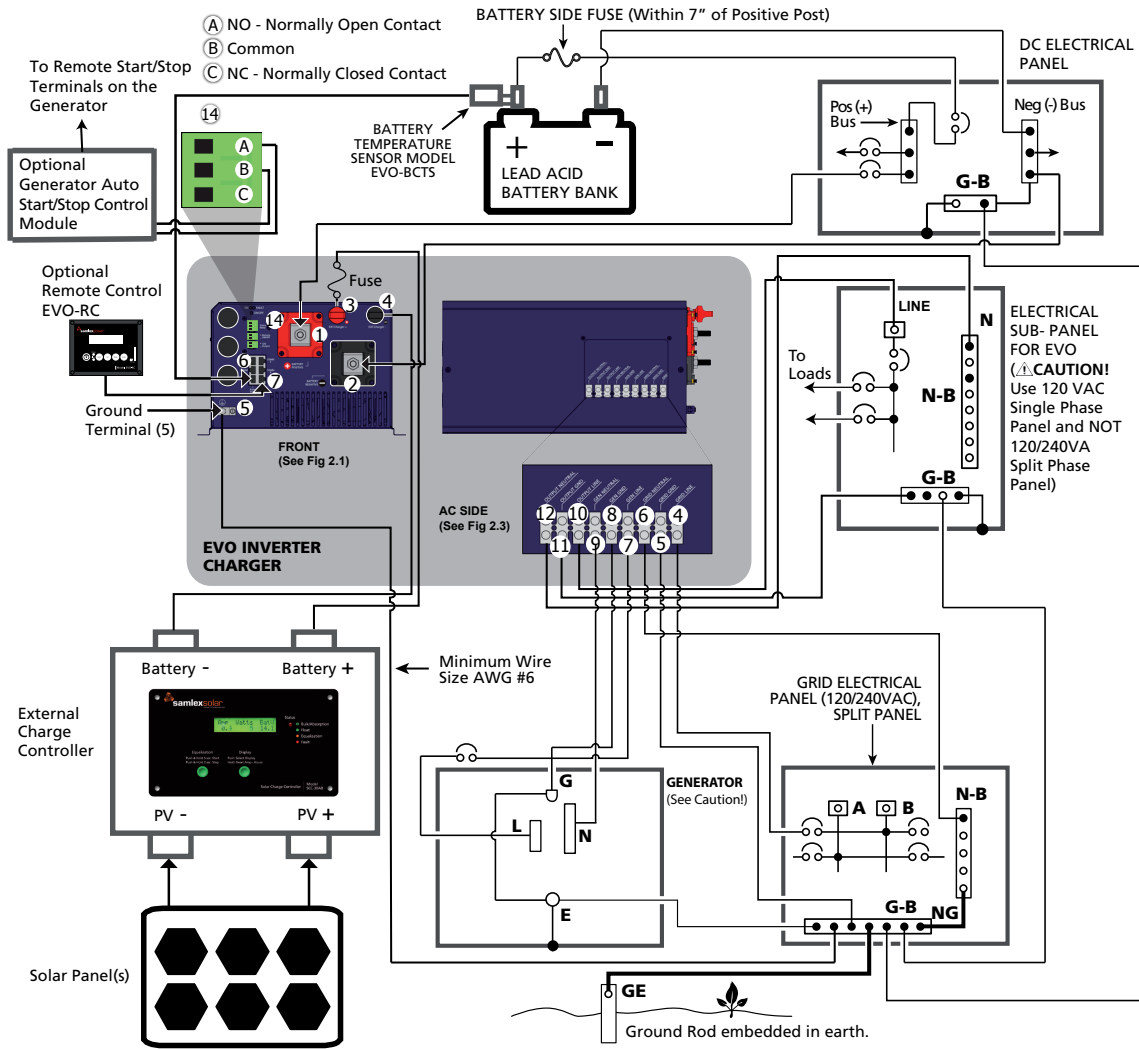

- | | | |
|--|---|--|
| <p>DC SIDE OF EVO</p> <ol style="list-style-type: none"> 1. Battery Positive 2. Battery Negative 3. External Charger Positive 4. External Charger Negative 5. Grounding Terminal 6. RF-45 Jack for Temperature Sensor 7. RJ-45 Jack for Optional Remote Control EVO-RC 14. Status Relay Terminals for initiating automatic generator start/stop | <p>AC SIDE OF EVO</p> <ol style="list-style-type: none"> 4. GRID LINE 5. GRID GND 6. GRID NEUTRAL 7. GEN LINE 8. GEN GND 9. GEN NEUTRAL 10. OUTPUT LINE 11. OUTPUT GND 12. OUTPUT NEUTRAL | <p>OTHER</p> <ul style="list-style-type: none"> Circuit breaker 120 VAC Leg A 120 VAC Leg B (Legs A&B are split phases) N-B Neutral Bus Bar NG Neutral to Ground Bond G-B Grounding Bus Bar GE Grounding Electrode (Ground Rod) E Earth Connector on generator (bonded to frame/chassis of the generator) N Neutral terminal of generator output L Line terminal of generator output G Grounding terminal of generator output |
|--|---|--|

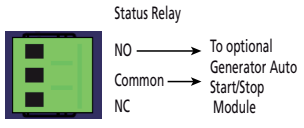

CAUTION!
Please ensure that:
(i) The generator chassis / frame is grounded to the Earth Ground through Ground Rod of the Grid Electrical Panel and
(ii) The Neutral conductor of the generator is NOT bonded to the chassis / frame of the generator. Please refer to Section 3.14.2 for details.

ATTENTION!
Veuillez vous assurer que :
(i) Le générateur / châssis châssis est relié à la masse de la Terre par l'intermédiaire de tige de mise à la terre du panneau électrique et grille
(ii) le conducteur neutre de la génératrice n'est pas collé sur le châssis / cadre de la génératrice. Veuillez vous reporter à la section 3.14.2 pour plus de détails.

Fig 3.14 Typical Shore Based Installation

SECTION 3 | Installation

3.18 MOBILE INSTALLATION - GENERAL INFORMATION

3.18.1 GFCI Protection for Vehicle Application

When this unit is installed in vehicles, it is to be ensured that Ground Fault Circuit Interrupter(s) [GFCI] are installed in the vehicle wiring system to protect all branch circuits.



WARNING!

Please ensure that Ground Fault Circuit Interrupter(s) [GFCI] are installed in the vehicle wiring system to protect all branch circuits.

GFCIs listed in Table 1.5 have been tested to operate satisfactorily and are acceptable.



MISE EN GARDE!

Veillez assurer que le(s) disjoncteur(s) de terre [GFCI] est/sont installé dans le système de câblage du véhicule pour protéger tous les circuits de dérivation.

Des disjoncteurs de terre ci-dessous ont été testé. Leur fonctionnement est acceptable, Table 1.5.

3.18.2 Requirement of Deep Cycle, Auxiliary Battery and Battery Isolator for Powering Inverters in Mobile Installations

Basic information on Lead Acid Batteries is given in Section 1.4 under "General Information - Lead Acid batteries". For details, read on-line White Paper titled "Batteries, Chargers & Alternator" at: www.samlexamerica.com (Home > Support > White Papers).

An RV / vehicle has Starter, Lighting and Ignition (SLI) battery. As explained in White Paper titled "Batteries, Chargers and Alternators", SLI batteries are designed to produce high power in short bursts for cranking.

SLI batteries use lots of thin plates to maximize the surface area of the plates for providing very large bursts of current (also specified as Cranking Amps). This allows very high starting current but causes the plates to warp when the battery is cycled. Vehicle starting typically discharges 1%–3% of a healthy SLI battery's capacity. The automotive SLI battery is not designed for repeated deep discharge where up to 80% of the battery capacity is discharged and then recharged. If an SLI battery is used for this type of deep discharge application, its useful service life will be drastically reduced. Hence, this type of battery is not recommended for the storage of energy for inverter applications. A second deep cycle auxiliary battery must be installed in the RV for powering the EVO™ (Deep cycle, auxiliary battery is shown in Figs. 3.15A and 3.15B).

When the second auxiliary deep cycle battery is used, a Battery Isolator is required that will allow parallel connection of the two batteries for charging when the alternator is ON and disconnecting the parallel connection when the alternator is stopped (Isolator is shown in Figs. 3.15A and 3.15B). The capacity of the Battery Isolator should be as follows:

SECTION 3 | Installation

- **For EVO-2012:** The maximum continuous DC current required is 266A. The capacity of the Battery Isolator should be more than 266A or more than the capacity of the alternator, whichever is higher
- **For EVO-2224:** The maximum continuous DC current required is 133A. The capacity of the Battery Isolator should be more than 133A or more than the capacity of the alternator, whichever is higher
- **For EVO-3012:** The maximum continuous DC current required is 373A. The capacity of the Battery Isolator should be more than 373A or more than the capacity of the alternator, whichever is higher
- **For EVO-4024:** The maximum continuous DC current required is 266A. The capacity of the Battery Isolator should be more than 266A or more than the capacity of the alternator, whichever is higher

3.18.3 Requirement to Keep the Neutral Conductor of Shore Power Isolated From the Chassis Ground of the RV

As explained in on-line White Paper titled “Grounded Electrical Power Distribution System” at www.samlexamerica.com (Home > Support > White Papers), in the RV, the Neutral Bus Bar is NOT bonded to the Chassis of the RV. In the RV, the Neutral is floating with respect to the chassis of the RV. This is necessary for safety because if the Neutral was bonded to the chassis of the RV and if the Neutral and the Hot got reversed by mistake, the chassis of the RV will be at 120 VAC with respect to the Earth Ground. If a person standing on the Earth Ground touches the chassis of the RV, he will be fed with 120 VAC and will receive electrical shock!

3.18.4 Typical Mobile Installation

Fig 3.15A illustrates typical RV installation using 30A, 120VAC, Single Phase Service Inlet and Fig 3.15B illustrates typical RV installation using 50A, 120/240VAC Split Phase Service Inlet:

- Auxiliary Battery is connected to the DC input connections through an appropriate fuse to protect the DC input cables against short circuit
- When AC input is not available from Grid / Generator, the auxiliary battery will be charged by the alternator through the Battery Isolator
- Battery Temperature Sensor Model BTS-EVO is installed on the Positive or Negative post of the auxiliary battery and connected to the RJ-45 Jack for the Temperature Sensor
- Supplementary battery charging is being carried out through a solar array and a Charge Controller connected to the DC input provided for external battery charger
- AC input to the EVO™ is fed from the Electrical Panel of the RV (through suitable breaker) and from the generator (through suitable breaker).
- If the RV has a 50A Service, 120VAC Single Phase input to the EVO™ can be fed from either of the 2 Split Phase Legs of the 50A RV Panel (through suitable breaker).
- AC output from the EVO™ is fed to the Electrical Sub-Panel for EVO™ (Use 120V version and NOT 120/240 Split Phase version of the Electrical Sub-panel)
- Automatic Generator start/stop is possible. Please see Section 4.7 for details.

SECTION 3 | Installation

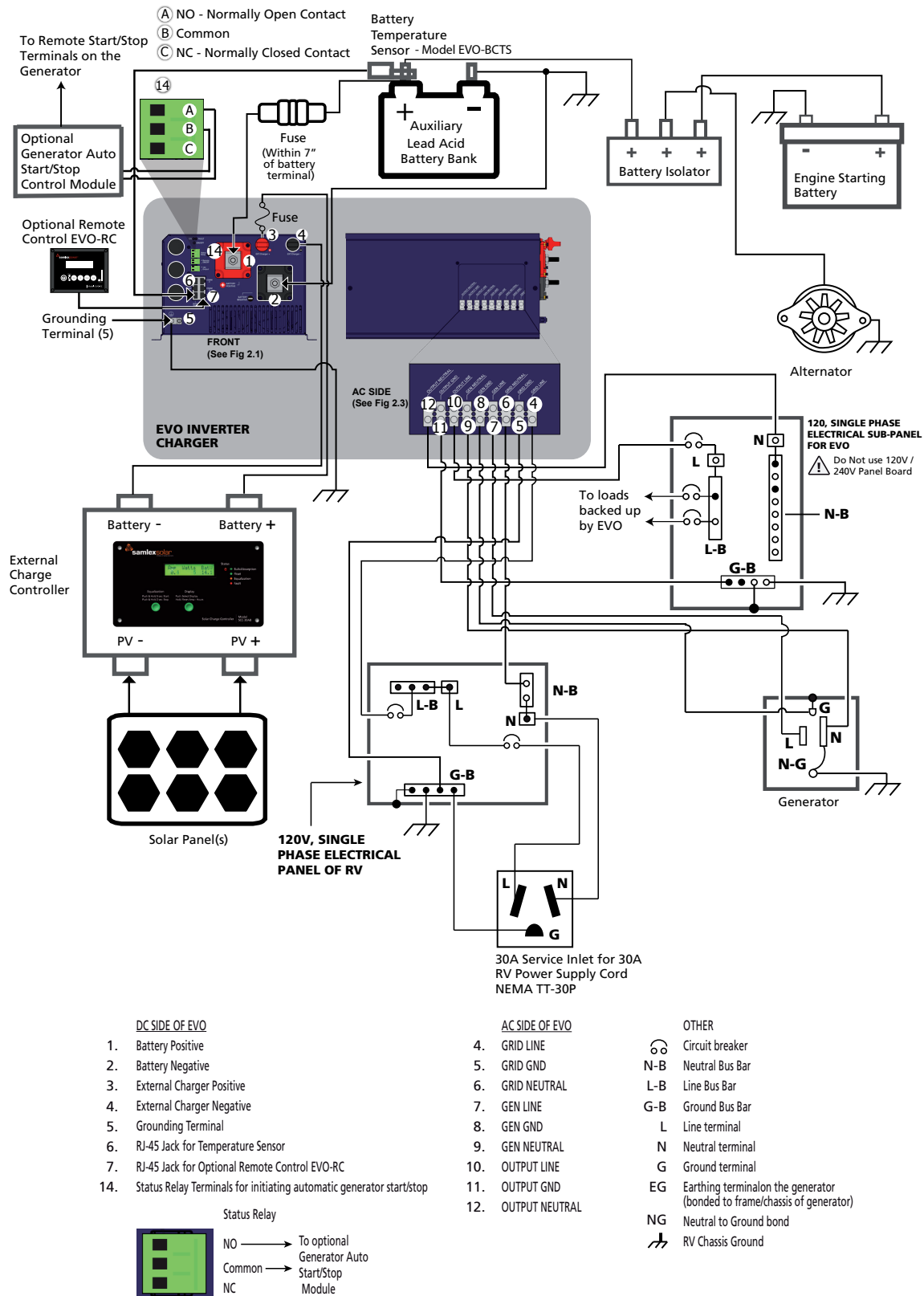
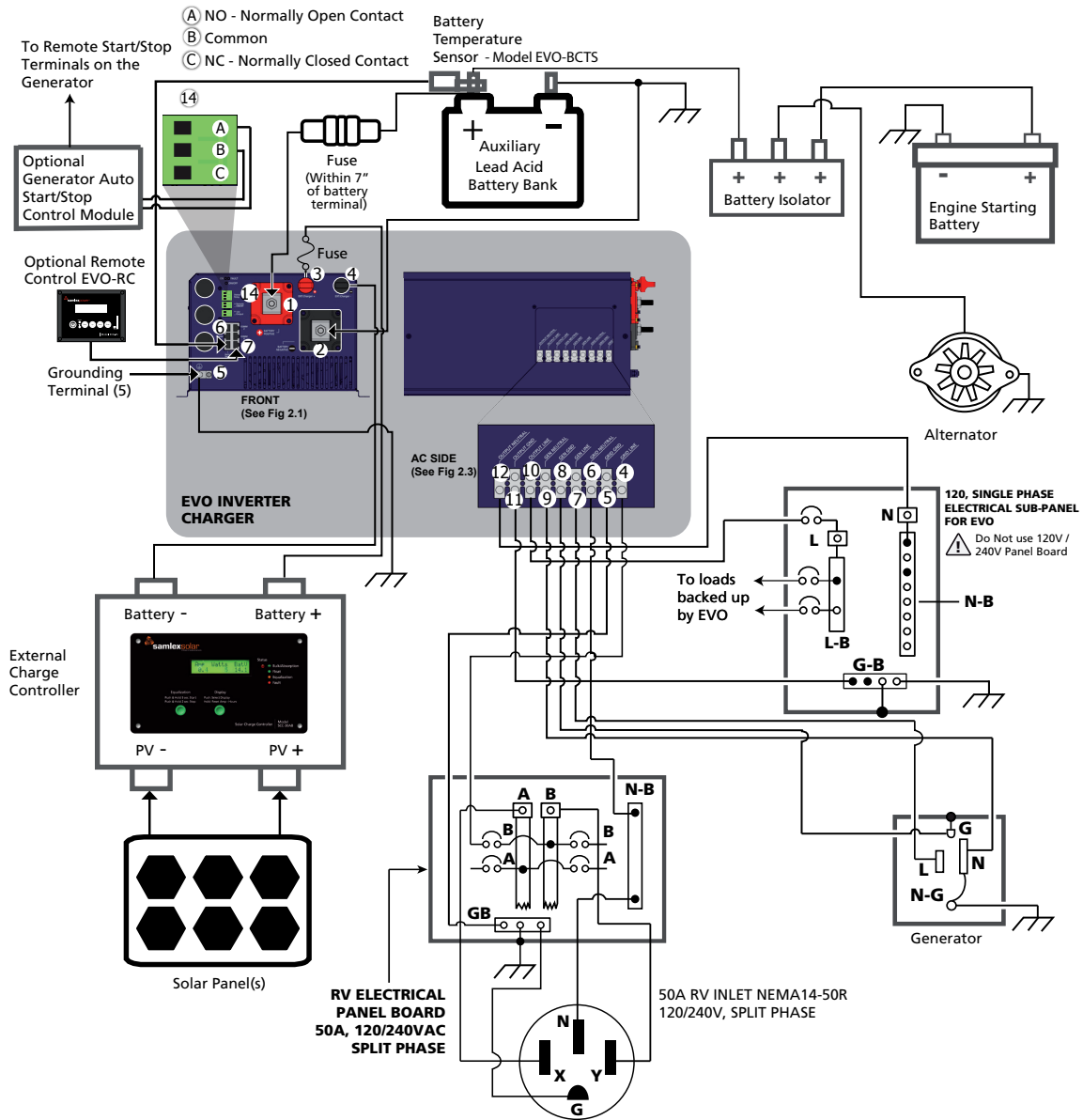

Fig 3.15A Typical Mobile Installation Using 30A, 120 VAC, Single Phase RV Service Inlet

SECTION 3 | Installation



- DC SIDE OF EVO**
1. Battery Positive
 2. Battery Negative
 3. External Charger Positive
 4. External Charger Negative
 5. Grounding Terminal
 6. RJ-45 Jack for Temperature Sensor
 7. RJ-45 Jack for Optional Remote Control EVO-RC
 14. Status Relay Terminals for initiating automatic generator start/stop

- AC SIDE OF EVO**
4. GRID LINE
 5. GRID GND
 6. GRID NEUTRAL
 7. GEN LINE
 8. GEN GND
 9. GEN NEUTRAL
 10. OUTPUT LINE
 11. OUTPUT GND
 12. OUTPUT NEUTRAL

- OTHER**
- Circuit breaker
 - N-B Neutral Bus Bar
 - L-B Line Bus Bar
 - G-B Ground Bus Bar
 - L Line terminal
 - N Neutral terminal
 - G Ground terminal
 - EG Earthing terminal on the generator (bonded to frame/chassis of generator)
 - NG Neutral to Ground bond
 - RV Chassis Ground

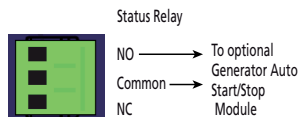

Fig 3.15B Typical Mobile Installation Using 50A, 120/240 VAC Split Phase RV Service Inlet

SECTION 4 | General Description & Principles of Operation

4.1 GENERAL DESCRIPTION

EVO Series is a Low Frequency Type, Pure Sine Wave, Single Phase Inverter-Charger with a built-in Transfer Relay. It uses high performance, 100MHz SP (Digital Signal Processing) type of micro-controller and Pulse Width Modulation (PWM) control. It is Bi-Directional i.e. it uses a common Converter Section consisting of Low Frequency Isolation Transformer and Mosfet based H-Bridge that can work in two directions as follows:

- 1) AC to DC Charging Mode: The common Converter Section is used to convert external AC input power from 2 sources (Grid or Generator or both) to DC output power to charge the batteries and at the same time, pass through the AC input power to the AC loads
- 2) DC to AC Inverting Mode: The common Converter Section is used to convert DC input power from the batteries to AC output power to feed the AC loads

The above Bi-Directional implementation allows the same power components to be used in both directions resulting in high- energy transfer efficiency with fewer components and higher reliability



Please note that as the unit is Bi-Directional with a common Converter Section as explained above, it cannot work as inverter and charger at the same time

4.2 COMPONENTS OF THE SYSTEM

It consists of 3 Sections – Inverter Section, Battery Charger Section and AC Input/Transfer Relay Section. The unit is fed with the following inputs:

- Up to 2 external, 120 VAC, Single Phase AC input power sources – Grid or Generator or both with PRIORITY for Grid if both Grid and Generator inputs are available at the same time
- DC Battery Source consisting of 12V/24V battery bank. - 4 versions of EVO are available. 2 versions for 12 VDC battery input (EVO-2212 and EVO-3012) & 2 for 24 VDC battery input (EVO-2224 and EVO-4024)
- Additional external charging source: Solar Charge Controller of up to 50A capacity. The output of the external Solar Charge Controller is routed through this unit and operates in parallel with the internal charger. The current delivered by the external charge controller is measured in real time. The internal charging current is controlled to ensure that the combined current fed to the battery does not exceed the programmed value of parameter "BULK CURRENT". This improves the life of the battery. Please see Section 5.4 for more details.

4.3 INVERTER SECTION

The Inverter Section is a heavy-duty, continuous rated, DSP micro-controller based inverter generating a Pure Sine Wave output of 120 VAC, 60 Hz / 50 Hz (60 Hz default) from the DC Battery Source. It is able to supply AC power to various types of AC loads such as resistive loads (heaters, incandescent lamps etc) or reactive loads (motors, air conditioners, refrigerators, vacuum cleaners, fans, pumps, Switched Mode Power Supplies (SMPS) used in audio / video equipment and computers, etc.).

4.3.1 Principle of working of Inverter Section

Low DC voltage from the DC Battery Source is inverted to AC voltage in two steps. Low DC voltage from the DC

SECTION 4 | General Description & Principles of Operation

Battery Source is first converted to low frequency (60 Hz or 50 Hz ; Default 60 Hz), low voltage synthesized sine wave AC using Mosfet based H-bridge configuration and high frequency (30 KHz) PWM (Pulse Width Modulation) technique. The low frequency, low voltage synthesized sine wave is then stepped up to 120 VAC pure sine wave voltage using a low frequency Isolation Transformer and filtration circuit to remove 30 KHz PWM frequency component. This type of DC to AC inversion is called Hybrid Type – a combination of low and high frequency implementation. Distinctive features of the Inverter Section are given below:

Soft Start: The inverter design incorporates “Soft Start” feature with the following advantages and protections:

- When the unit powers up, it starts in Inverting Mode first. The output voltage ramps up gradually from around 48 VAC to 120 VAC in around 200 ms. This reduces otherwise very high starting inrush current drawn by AC loads like Switched Mode Power Supplies (SMPS) and motor driven loads like fans, pumps, compressors etc. This will result in lower motor inrush current (which typically can be up to 650% of the full load current of the motor), which means lesser mechanical stresses, wear and tear and increased lifetime of the motor, coupling and fan. Additionally, the impact on the load side components is greatly reduced, meaning less likelihood of causing problematic voltage drops during starting.

Power Surge – Up to 300%:

- The inverter is able to deliver very high surge power / current of up to 300% for 1 ms followed by 200% for 100 ms. This range of high instantaneous power is delivered at the rated voltage and hence, it is able to provide very high starting torque for difficult motor driven loads like compressors and pumps that require higher Locked Rotor Current during startup.
- If the power drawn by the load exceeds the above surge ratings, the inverter protects itself by limiting the load current to 300% / 200% which results in reduction of output voltage and consequent reduction in load current. The output voltage recovers automatically when power drawn by the load drops below the above surge limits

Power Boost up to 150%: Higher percentage of rated power can be provided for limited time periods as follows:

- 150% for 5 sec
- 140% for 30 sec
- 120% for 5 min
- 110% for 30 min

4.4 DIRECT DUAL AC INPUT ARCHITECTURE

For higher reliability and redundancy, direct AC input from 2 AC input sources e.g. Grid / Generator can be fed simultaneously to separate AC Input Terminals marked "GRID" (4, 5, 6 in Fig 2.3) and "GEN" (7,8,9 in Fig 2.3). Only one AC input source is selected at one time. When both the AC input sources are available simultaneously, the AC input source connected to terminals marked "GRID" (4, 5, 6 in Fig 2.3) is given priority. Transfer between the 2 AC input sources is always routed through the inverter. Please see details under Sections 4.5.4 to 4.5.7.

4.5 TRANSFER RELAY SECTION

Transfer Relay Section is used to either feed AC input power from external AC input source (e.g. Grid/Generator) to the Battery Charger Section and at the same time, pass through the AC power from the external AC input power source to the load (As long as the external AC input power from any of the 2 AC input sources is available and

SECTION 4 | General Description & Principles of Operation

is within the programmed limits of voltage and frequency) or to transfer the load to the Inverter Section (In case of loss of the external AC input power source or if this source is not within the programmed limits of voltage and frequency). Typical transfer time is 16 milliseconds from the AC input source to Inverter and <1ms from Inverter to the AC input source. Heavy duty 70A (2x35A poles in parallel), Transfer Relay [K2, K3 in Fig 4.1(b)] is used for reliable transfer of power in EVO-4024/ EVO-3012. 40A Transfer Relay [K2, K3 in Fig 4.1(a)] is used for EVO-2212/ EVO-2224.

4.5.1 AC Transfer and Output Neutral To Chassis Ground Bond Switching

As required by NEC and UL Standard 458, automatic switching of bonding between the Output Neutral and Chassis Ground has been provided in EVO through "Output Neutral to Chassis Ground Bond Switching Relay" [K4 in Figs 4.1(a) and 4.1(b)]. Switching of bonding is carried out as follows:

- (a) When operating as an inverter, the current carrying conductor of the Inverter Section that is connected to the Output Neutral terminal of EVO is bonded to the metal chassis of EVO by the "Output Neutral to Chassis Ground Bond Switching Relay" [K4 in Figs 4.1(a) and 4.1(b)]. As the metal chassis of EVO is in turn bonded to the Earth Ground (in shore installations) or to the RV Ground (chassis of the RV) or to the Boat Ground (DC Negative Grounding Bus Bar and the Main AC Grounding Bus Bar are tied together in a boat and this is called the "Boat Ground"), this current carrying conductor of the Inverter Section (connected to the output terminal) will become the Grounded Conductor (GC) or the Neutral of the Inverter Section.
- (b) When in Charging Mode, the Neutral conductor of the Grid power/Generator will be connected to the Output Neutral terminal of EVO. At the same time, the "Output Neutral to Chassis Ground Bond Switching Relay" [K4 in Figs 4.1(a) and 4.1(b)] will unbond (disconnect) the Output Neutral connector of EVO from the metal chassis of EVO. This will ensure that the Grounded Conductor (GC) i.e. the Neutral of the Grid power/Generator is bonded to the Earth Ground at one single point at the location of the AC Power Distribution System of the Marina/RV Park/Shore Power.
- (c) **Disabling Neutral to Ground Bond:** In some applications, the Output Neutral of EVO may be required to remain isolated from the chassis/Ground at all times. For this, automatic Output Neutral to Ground bond can be disabled by disconnecting the Male/Female Quick Disconnect located in the AC wiring compartment. [Please see (i) 13, Fig 3.9 and (ii) "QD" in Figs 4.1(a) and 4.1(b)]

Please read the following on-line White Papers for more details at www.samlexamerica.com (Home > Support > White Papers):

- "Neutral to Ground Switching in RV and Marine Applications"

4.5.2 Operation of Transfer Relay and Output Neutral to Chassis Ground Bond Switching Relay – EVO-2212 and EVO-2224

Refer to Schematic at Fig 4.1(a)

The Bi-directional Transformer is used as follows:

- Feeds AC output from the Inverter Section when Grid / Generator power is not available.
- Feeds Grid / Generator power to the Battery Charger Section when Grid / Generator are available.

Switching of Hot Output (OUTPUT LINE)

- 40A rated SPDT Relays K2 and K3 are used to switch the Hot Output Connector (**OUTPUT LINE**) to either the Inverter Section or to the AC input source.
- When power from AC input source is available, relays K2 or K3 will be energized and contact 4 switches over

SECTION 4 | General Description & Principles of Operation

to contact 5 (AC input source connected to AC input terminals marked GRID (4, 5, 6 in Fig 2.3) has PRIORITY over the AC input source connected to AC input terminals marked GEN (7, 8, 9 in Fig 2.3) if both are present simultaneously). The Bidirectional Transformer works as a battery Charger. The Hot AC input from the AC input terminal marked (GRID LINE) or from the AC input terminal marked (GEN LINE) is fed to the Hot input of the Bi-directional Transformer for battery charging and at the same time, it is passed through to the Hot Out (OUTPUT LINE) for powering the AC loads.

- When AC input power fails, relays K2 / K3 will be de-energized and contact 4 switches back to contact 3. Output from the Inverter Section is fed to the Bi-directional Transformer and onwards to the Hot Out (OUTPUT LINE) for powering the AC loads.

Switching of Bonding of Output Neutral to Chassis Ground

- 40A rated SPDT Relay K4 is used to switch the bonding of the Output Neutral Connector (OUTPUT NEUTRAL) to the chassis of the unit
- When AC input Power is available, relay K4 will be energized and contact 4 switches over to contact 5. Neutral input from the terminal marked (GRID NEUTRAL) or from the terminal (GEN NEUTRAL) is fed to the Neutral input of the Bi-directional Transformer for battery charging and at the same time, it is passed through to the Output Neutral (OUTPUT NEUTRAL) for powering the AC loads. Please note that in this condition, the Output Neutral (OUTPUT NEUTRAL) is isolated from the chassis of the unit
- When AC input power fails, relay K4 will be de-energized and contact 4 switches back to contact 3. Neutral output from the Inverter Section is fed the Neutral of the Bi-directional Transformer and onwards to the output Neutral (OUTPUT NEUTRAL) for powering the AC loads. At the same time, the output Neutral (OUTPUT NEUTRAL) gets bonded to the metal chassis of the unit through the mated contacts of the Insulated Quick Disconnect "QD" located in the AC Wiring Compartment (13, Fig 3.9).

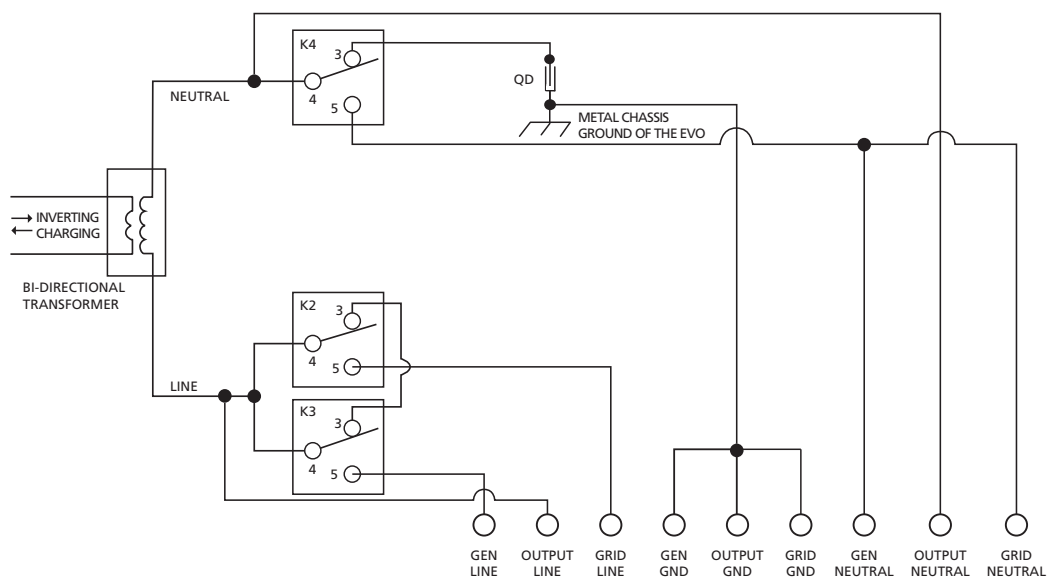

Fig 4.1(a) Operation of Transfer Relay and Switching of Bond Between Output Neutral & Metal Chassis Ground – EVO-2212 & EVO-2224 (See Legend on the next page)

SECTION 4 | General Description & Principles of Operation

Legend for Fig 4.1(a)

K2	Transfer Relay (40A) for AC source connected to terminal marked "GRID LINE"
K3	Transfer Relay (40A) for AC source connected to terminal marked "GEN LINE"
K4	Relay (40A) for Neutral to Ground bond Switching
4, 3	Normally Closed Contacts
4, 5	Normally Open Contacts
QD	Quick Disconnect (13, Fig 3.9) for disconnecting Output Neutral to Chassis Ground bond in Inverting Mode (Default - connected). <i>Refer to Section 4.5.1(c) for application information.</i>
NOTE:	Relays are de-energized in Inverting Mode and are energized in Charging Mode

4.5.3 Operation of Transfer Relays and Output Neutral to Chassis Ground Bond Switching Relay – EVO-3012 and EVO-4024

Refer to Schematic at Fig 4.1(b)

The Bi-directional Transformer is used as follows:

- Feeds AC output from the Inverter Section when AC input power is not available.
- Feeds AC input power to the Battery Charger Section when AC input power is available.

Switching of Hot Output (OUTPUT LINE)

- 70A rated DPDT Relays K2 and K3 are used to switch the Hot Output Connector (**OUTPUT LINE**) to either the Inverter Section or to the AC input source. Please note that in this relay, each of the 2 poles is rated for 35A. The 2 poles are used in parallel to increase the contact current carrying capacity to 70A.
- When AC input Power is available, relays K2 or K3 will be energized and contacts 7 and 9 will switch over to contacts 4 and 6 respectively [AC input power source connected to AC input terminals marked GRID (4, 5, 6 in Fig 2.3) has PRIORITY over AC input power source connected to AC input terminals marked GEN (7, 8, 9 in Fig 2.3) if both are present simultaneously]. The Bidirectional Transformer works as a battery Charger. The Hot AC input from the terminal marked (GRID LINE) or from the terminal marked (GEN LINE) is fed to the Hot input of the Bi-directional Transformer for battery charging and at the same time, it is passed through to the Hot Out (OUTPUT LINE) for powering the AC loads.
- When AC input power fails, relays K2 / K3 will be de-energized and contacts 7 and 9 will switch back to contacts 1 and 3 respectively. Output from the Inverter Section is fed to the Bi-directional Transformer and onwards to the Hot Out (OUTPUT LINE) for powering the AC loads.

Switching of Bonding of Output Neutral to Chassis Ground Bonding

- 70A rated DPDT Relay K4 is used to switch the bonding of the Output Neutral Connector (OUTPUT NEUTRAL) to the chassis of the unit. Please note that in this relay, each of the 2 poles is rated for 35A. The 2 poles are used in parallel to increase the contact current carrying capacity to 70A.
- When AC input power is available, relay K4 will be energized and contacts 7 and 9 will switch over to contacts 4 and 6 respectively. Neutral input from terminal (GRID NEUTRAL) or from terminal (GEN NEUTRAL) is fed to the Neutral input of the Bi-directional Transformer for battery charging and at the same time, it is passed through to the output Neutral (OUTPUT NEUTRAL) for powering the AC loads. Please note that in this condition, the Output Neutral (OUTPUT NEUTRAL) is isolated from the chassis of the unit.

SECTION 4 | General Description & Principles of Operation

- When AC power fails, relay K4 will be de-energized and contacts 7 and 9 will switch back to contacts 1 and 3 respectively. Neutral output from the Inverter Section is fed the Neutral of the Bi-directional Transformer and onwards to the output Neutral (OUTPUT NEUTRAL) for powering the AC loads. At the same time, the output Neutral (OUTPUT NEUTRAL) gets bonded to the chassis of the unit through the mated contacts of the Insulated Quick Disconnect "QD" located in the AC Wiring Compartment (13, Fig 3.9)

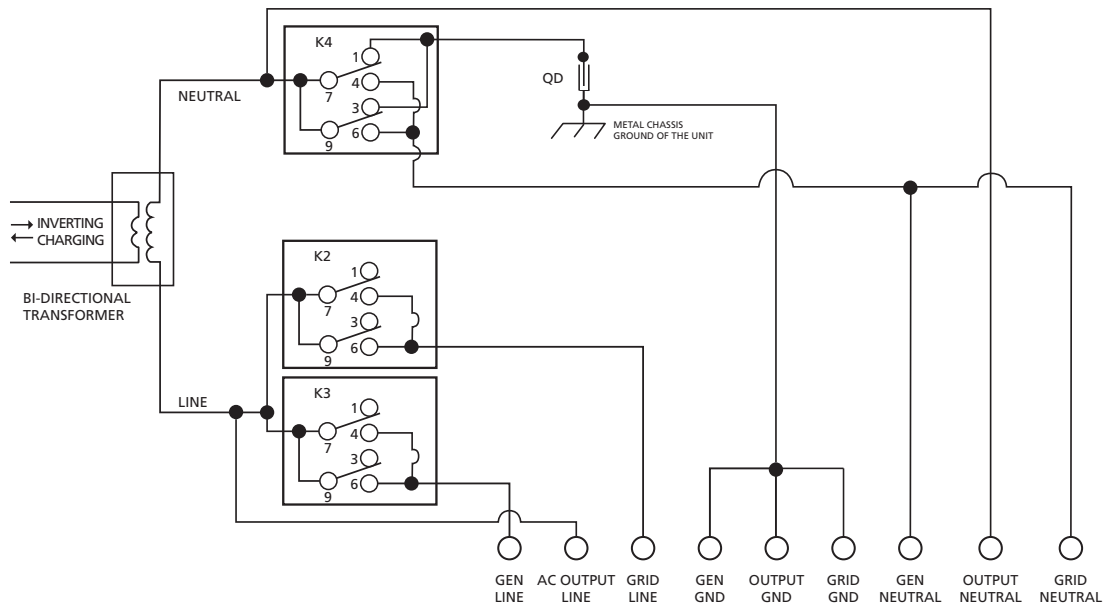

Fig 4.1(b) Operation of Transfer Relay and Switching of Bond between Output Neutral & Metal Chassis Ground – EVO 3012 & EVO-4024

Legend for Fig 4.1(b)

K2	DPDT Transfer Relay (70A) for AC input connected to terminal marked GRID LINE <ul style="list-style-type: none"> Two 35A each poles are paralleled for 70A capacity
K3	DPDT Transfer Relay (70A) for AC input connected to terminal marked GEN LINE <ul style="list-style-type: none"> Two 35A each poles are paralleled for 70A capacity
K4	DPDT Transfer Relay (70A) for Neutral to Ground Bond Switching <ul style="list-style-type: none"> Two 35A each poles are paralleled for 70A capacity
7,1 and 9,3	Normally Closed Contacts
7,4 and 9,6	Normally Open Contacts
QD	Quick Disconnect (13, Fig 3.9) for disconnecting Output Neutral to Chassis Ground bond in Inverting Mode (Default - connected). <i>Refer to Section 4.5.1(c) for application information.</i>
NOTE:	Relays are de-energized in Inverting Mode and are energized in Charging Mode

SECTION 4 | General Description & Principles of Operation

4.5.4 Synchronized Transfer of Power

4.5.4.1 General information

When the frequency and phase of output voltages of two AC power sources are the same (in sync), the two AC sources are considered to be “synchronized”.

Critical AC loads require un-interruptible AC input power. It is, therefore, necessary that when the primary AC input power is interrupted / fails, the load should be transferred to the backup AC source “very quickly” within the “holdup time” of the load(s).

When AC power feeding motors or inductive loads like transformers etc. is interrupted / fails, residual voltage is induced in the load due to “generator effect” created by a rotating motor or by the stored energy released from the inductive loads like transformer’s windings or core. The induced residual voltage in the load has the same frequency and phase as the voltage of AC input power when it failed and, this voltage does not dissipate immediately but within a few seconds. This induced residual voltage in the load can cause extremely high inrush currents to occur when such loads are “very quickly” transferred to a “non-synchronized” source of backup AC power (the loads are transferred to the “non-synchronized” backup source before the residual voltage in the load(s) has dissipated). The resulting effect, frequently described as “bumping” can initiate nuisance tripping of circuit protective devices or in extreme cases, cause mechanical damage to motor shaft and couplings. To prevent this abnormal operating condition when the load is transferred between the primary and backup AC sources “very quickly (normally within around 16 ms)”, it is to be ensured that the voltage of the backup AC power source is always kept “synchronized” with the voltage of the primary AC power source.

Synchronization control logic used in a backup AC source is required to be based on the frequency stability characteristics of the primary AC source which can be Grid or Generator. The frequency of Grid voltage is very stable. On the other hand, the frequency of Generator voltage (except Inverter Generators) may vary considerably depending upon the performance of its Speed Governor that compensates for the drop in RPM / frequency when electrical load is switched on / increased or, rise in RPM / frequency when electrical load is decreased / switched off.

4.5.4.2 Synchronization Algorithm Options in EVO for Grid and Generator Inputs

When operating as an Inverter Charger, the EVO is designed to accept external AC input power directly from two AC input sources through AC input terminals marked “GRID” (4,5,6 in Fig 2.3) and “GEN” (7,8,9 in Fig 2.3). Internally, only one AC input source is selected at one time. When both AC input sources are available simultaneously, AC input source connected to terminals marked “GRID” is given priority (See Section 4.5.7).

The frequency and phase of the internal backup Inverter Section are always kept synchronized with the AC input source. This facilitates “extremely fast” transfer time of up to 16 ms. Also, transfer from the Inverter Section to the AC input source and vice versa takes place at zero crossing of the voltage waveform – this ensures (i) negligible arcing / erosion of Transfer Relay contacts and (ii) negligible Electromagnetic Interference (EMI) associated with arcing.

2 Programming parameters “SYNC GRID” [for AC input source connected to AC input terminals marked “GRID” (4,5,6 in Fig 2.3)] and “SYNC GEN” [for AC input source connected to AC input terminals marked “GEN” (7,8,9 in Fig 2.3)] have been provided with two synchronization algorithm options each: (i) 0= Fine, or (ii) 1= Coarse as shown in TABLE 4.1. Option “0 =Fine” is recommended for AC input power source that has more stable output frequency like Grid / Inverter Generator. Option “1= Coarse” is recommended for AC input power source with less stable output frequency like Generator.

SECTION 4 | General Description & Principles of Operation

TABLE 4.1 SYNCHRONIZATION ALGORITHM OPTIONS ON AC INPUT TERMINALS

AC Input Terminals	Synchronization Algorithm Options			
	AC Input Source is Grid or Inverter Generator		AC Input Source is Generator	
	Programming Parameter	Option	Programming Parameter	Option
GRID (4,5,6 in Fig 2.3)	SYNC GRID (See NOTE 1)	0=Fine (Default)	SYNC GRID (See NOTE 1)	1=Coarse
GEN (7,8,9 in Fig 2.3)	SYNC GEN (See NOTE 2)	0=Fine	SYNC GEN (See NOTE 2)	1=Coarse (Default)

NOTES:

1. For programming details for parameter SYNC GRID, please refer to Section 4.5.2.8 in EVO-RC Remote Control Manual attached at Appendix A
2. For programming details for parameter SYNC GEN, please refer to Section 4.5.2.9 in EVO-RC Remote Control Manual attached at Appendix A

4.5.5 Transfer From Inverter Section to AC Input Source

When power from AC input source connected to terminals marked "GRID" (4,5,6 in Fig 2.3) or "GEN" (7,8,9 in Fig 2.3) is made available, its voltage and frequency are monitored for 2 sec to check if these are within the programmed limits. If yes, the output voltage of the Inverter Section is synchronized with the AC input source. This synchronization process takes few seconds. Once synchronization is completed, the load is transferred instantly (within 1 ms) to the AC input source at Zero Crossing of the voltage waveform for safer transfer and for better protection of Transfer Relay contacts. The unit now operates in "Charging Mode" with the AC power from the AC input source charging the batteries as well as providing power to the AC loads.

4.5.6 Transfer From AC Input Source to Inverter Section

When the unit is operating in "Charging Mode" with the AC input source charging the batteries as well as providing power to the AC loads, the phase and frequency of the AC input source are tracked continuously. In case AC input source fails or is disconnected, the inverter will be forced to transfer at voltage which is at the same phase and frequency at which the AC input source had been disconnected. Load will be transferred to the inverter within 16ms at zero crossing. The unit will now work in "Inverting Mode" and the batteries will start discharging.

4.5.7 Transfer Between AC Sources Connected to Terminals Marked "GRID" & "GEN"

As discussed in section 4.5.5 above, the EVO prioritizes the AC source connected to AC input terminals marked "GRID" over the AC source connected to AC input terminals marked "GEN". If the EVO is operating with the AC source connected to terminals marked "GEN" and the AC input from AC source connected to AC input terminals marked "GRID" is restored, the EVO will first transfer the load to its Inverter Section, and then transfer back to the AC source connected to AC input terminals marked "GRID". Both operations are synchronized and the transfer is at the zero crossing for a seamless transfer.

4.6 BATTERY CHARGER SECTION

The Battery Charger Section of these units provide 2/3/4 stage charging with 7 programmable charging profiles as detailed at Section 5.6. The same Isolation Transformer and the H-Bridge configuration of the Inverter Section are

SECTION 4 | General Description & Principles of Operation

used to work in the reverse direction, i.e. the AC input is stepped down and rectified to the programmed DC battery charging voltage using Pulse Width Modulation (PWM) Control. That is why it is called a Bi-directional device. Further, the charging voltages and currents are programmable to take care of a wide range of battery types like Lead Acid, Nickel-Zinc (Ni-Zn) & Lithium Ion.

Important battery charging features are as follows:

- Adaptive Charging Control for 2 Charging Profiles out of the 7 profiles
- Dynamic Input Power Diversion Control
- Parallel charging through External Charge Controller
- Temperature compensated charging
- Programmable Charging Profiles for Lead Acid, Nickel-Zinc (Ni-Zn) and Lithium Batteries

Please see details under Section 5 titled "Battery Charging in Evolution™ Series".

4.7 AUTO GENERATOR START / STOP

Auto Generator Start / Stop function has been provided using "Common" and Normally Open "NO" contacts of Status Relay (14, Fig 2.1). The relay is SPDT Type with contacts rated at 3A, 125 VAC / 30 VDC. Appropriate external Generator Auto Start / Stop Module will be required for using this function. 3 options (Options 2, 3 and 4 under programming parameter "RELAY FUNCTION") are available for carrying out this function depending upon user requirements. *For details, please refer to Section 4.8.2.5.2 in the EVO-RC Remote Control Manual attached at Appendix A.*

The "Common" and "NO" terminals are wired to the optional Generator Auto Start / Stop Control Module which, in turn, is wired to the Remote Start / Stop connections on the Generator. The AC output terminals of the Generator are wired to the Generator Input Terminals on the EVO (7, 8, 9 in Fig 2.3). *For installation details, please refer to Section 3.17 / Fig 3.14 and Section 3.18 / Fig 3.15A & B.*



INFO

It is recommended that "GSCM-Mini" Series of Generator Start / Stop Control Module, appropriate for the generator to be used, may ordered directly from Atkinson Electronics www.atkinsonelectronics.com

Based on the Generator Start Logic contained in of one of the selected Options 2, 3 or 4 (under programming parameter "RELAY FUNCTION" *[See Sections 4.8.2.5.2 in EVO-RC Remote Control Manual at Appendix A]*, the Status Relay will be switched ON (energized), its "Common" and "NO" contacts will close and the external Generator Start / Stop Control Module will initiate automatic starting of the Generator. Once the Generator has started and starts feeding AC output to EVO (within the programmed limits of voltage and frequency), the EVO will be synchronized with the Generator and once synchronization is completed, the load will be transferred instantly (*within 1 ms*) to the Generator at Zero Crossing of the voltage waveform for seamless transfer and for better protection of Transfer Relay contacts. The EVO will now operate in "Charging Mode" with the AC power from the Generator charging the batteries as well as providing power to the AC load(s).

Based on the Generator Stop Logic contained in one of the selected Options 2, 3 or 4 under programming parameter "RELAY FUNCTION" *[See Sections 4.8.2.5.2 in EVO-RC Remote Control Manual at Appendix A]*, the Status Relay will be switched OFF (de-energized), its "Common" and "NO" contacts will open and the external Generator Auto Start Control

SECTION 4 | General Description & Principles of Operation

Control Module will initiate automatic stopping of the Generator. When AC output of the generator is shut down, the EVO will automatically transfer the AC load(s) to the "Inverter Section" within 16 ms.

4.8 MODES OF OPERATION

4.8.1 Charging Mode

As long as the external AC input power from the Grid/Generator is available and is within the programmed limits of voltage and frequency, it is passed through to the AC load through the Transfer Relay Section. At the same time, the Battery Charger Section converts the external AC input power from the Grid/Generator to DC power to charge the DC Battery Source.

4.8.2 Inverting Mode

If at any instant, the external AC input power from the Grid/Generator is interrupted or is not within the programmed limits of voltage and frequency, the Transfer Relay is de-energized and the load is transferred to the Inverter Section and internal battery charging is terminated. This is called the Inverting Mode.

4.8.3 Power Saving Mode

Power Saving Mode related to inverters is a function designed to conserve battery power when the inverter is in ON condition and no AC loads are connected to it or, AC loads are connected to it but have been switched OFF. This condition is also called "No Load Condition".

When an inverter is operating under "No Load Condition", it will consume a small amount of input power from the battery to keep all internal circuits alive and be ready to deliver the full rated output voltage and power to the load once the load is switched ON. This input power drawn from the battery when no load is being supplied by the inverter is called the "No Load Power Draw" (also called "Idle Power" or "Self Power Consumption"). This "No Load Power Draw" is proportional to the size of the inverter e.g. a 150 Watt inverter may have "No Load Power Draw" of around 6W and a 3000W may have "No Load Power Draw" of around 30W. This power is wasted and drains the battery unnecessarily. It is, therefore, desirable to reduce the "No Load Power Draw" to the minimum.

The "No Load Power Draw" of EVO Series in the Normal Operating Mode is around 25 - 30W.

The EVO has an optional programmable operating mode called "Power Saving Mode" that is designed to reduce this "No Load Power Draw" to less than 8W during conditions where the Inverter Section is ON but is not supplying any load [Applicable only when the unit is operating in "Inverting Mode"].

Enabling / disabling of "Power Saving Mode" is carried out using optional Remote Control Model EVO-RC. The EVO is shipped with the "Power Saving Mode" option in "Disabled" condition [Programming Parameter "POWER SAVING" is set at "0=Disabled" in the Default condition – See Section 4.8.2.1 of the EVO-RC Remote Control Manual attached at Appendix A].

When "Power Saving Mode" is enabled, the Inverter Section will NOT provide full rated output voltage of 120 VAC of Normal Operating Mode but pulsing output voltage consisting of 3, 60 Hz cycles of "reduced 48Vrms load search voltage" every 0.5 sec. This output voltage is used to "search" if a load is being powered and also to measure the power drawn by this load [The power drawn by the load will be initially measured based on pulsing output voltage consisting of 3, 60 Hz cycles of "reduced 48VAC load search voltage" every 0.5 sec and from there, the power will be

SECTION 4 | General Description & Principles of Operation

calculated based on the rated output voltage of 120VAC for the Normal Operating Mode. Operation of the “Power Saving Mode” is controlled through the following programming parameters:

- **4.8.3.1 Parameter “ENTER POINT”** [See Section 4.8.2.2 in the EVO-RC Remote Control Manual attached at Appendix A]

This parameter determines the threshold of power drawn by the load at which the EVO will exit the Normal Operating Mode (full 120VAC output voltage; No Load Power Draw from the battery will be 25-30W) and “enter” Power Saving Mode (output voltage consisting of 3, 60 Hz cycles of “reduced 48VAC load search voltage” every 0.5 sec; No Load Power Draw from the battery will be < 8W).

The programmable range of this parameter is 4-50Watts; Default value is 6W for EVO-2212 / 2224 and 8W for EVO-3012/4024.

Whenever the Inverter Section is switched ON with “Power Saving Mode” in enabled condition, it will initially start in Normal Operating Mode [Full 120VAC output voltage; No Load Power Draw from the battery will be 25-30W]. It then measures the power drawn by the load, if any, based on Normal Operating Voltage of 120VAC. If the power drawn by the load is \leq the programmed power value of “Enter Point”, the Inverter Section will enter “Power Saving Mode” (pulsing output voltage consisting of 3, 60 Hz cycles of “reduced 48Vrms load search voltage” every 0.5 sec). It is, therefore, important to first determine the running power consumption of your load in Watts and then, ensure that the programmed value of parameter “ENTER POINT” is $>$ the running power of the load. If the running power of the load is $<$ the programmed value of parameter “ENTER POINT”, the load may turn ON initially due to higher initial startup surge power but will turn OFF when it starts drawing lower running power that is $<$ the programmed value of parameter “ENTER POINT”. (**NOTE:** The initial startup surge power of AC loads may be up to 10 times higher than their “running power” depending upon the type of AC load).

- **4.8.3.2 Parameter “WAKE UP POINT”** [See Section 4.8.2.3 in the EVO-RC Remote Control Manual attached at Appendix A]:

Once the inverter enters “Power Saving Mode” as described at Section 4.8.3.1 above [Output voltage consisting of 3, 60 Hz cycles of “reduced 48VAC load search voltage” every 0.5 sec; Power draw from the battery will be < 8W], it will continue to remain in this mode till the time the power drawn by the load is \geq than the programmed threshold of Parameter “WAKE UP POINT” [Programmable range is 4-50Watts; Default is 7W for EVO-2212 / 2224 and 10W for EVO-3012/4024]. When the power drawn by the load \geq the programmed threshold of Parameter “WAKE UP POINT”, the EVO will wake up and change to the Normal Operating Mode (full 120VAC output voltage; No Load Power Draw from the battery will be 25-30W).



Power Saving Mode should be disabled for the following loads:

- Low power loads that draw less than 5W e.g. digital clocks, satellite receivers, phones / answering machines etc.
- Audio / video / computing devices that consume normal operating power $>$ 50 W but draw less than 5W on entering Sleep Mode when switched off or , when no activity is seen for a specified time.
- Some devices like small fluorescent lights, refrigerators, microwaves, computers and other sophisticated electronics may not be detected when scanned by the output voltage characteristics of the Power

SECTION 4 | General Description & Principles of Operation

Saving Mode [Output voltage consisting of 3, 60 Hz cycles of “reduced 48VAC load search voltage” every 0.5 sec]. These devices have power supplies in their front end that do not present a load until the full 120VAC line voltage is available.

4.8.4 Power Saving Mode - Transfer Characteristics

- **Transfer from Grid / Generator to Inverter:** If qualified Grid or Generator AC input power is available (its voltage and frequency are within the programmed range), the Transfer Relay remains energized and the AC input power is passed through to the load and at the same time, the unit operates as a battery charger. If AC input power from Grid / Generator fails or is not qualified (its voltage and frequency are not within the programmed range), the Transfer Relay is de-energized and the load is transferred to the inverter. *When this transfer takes place, the inverter initially operates in Normal Mode.* If the AC load was greater than the programmed value of “Wake-up Point”, the inverter continues in Normal Mode. However, if it sees a load less than the programmed value of “Enter Point” for around 5 sec, it enters Power Saving Mode.
- **Transfer from Inverter to Grid / Generator:** As soon as qualified AC input power from Grid / Generator is available, the inverter will exit Power Saving Mode and will switch over to Normal Mode. *This switch over is necessary for synchronizing the AC output of the inverter with the AC input before transfer (Synchronization can not be carried out with pulsing wave form during Power Saving Mode).* After synchronization is completed, the load is transferred to the Grid/Generator at zero crossing of the voltage waveform.

4.8.5 Normal (Off-Line), On-Line and Charger Only Modes

EVO has 3 modes of operation as follows that can be programmed through programming parameter “MODE” *[For details, see Section 4.4.2.13 in the EVO-RC Remote Control Manual attached at Appendix A]*

- Option “0=Normal”** (Default). Also called Off-Line Mode. See details at Section 4.8.5.1 below
- Option “1=On-Line”**. See details at Section 4.8.5.2 below
- Option “2=Charger Only”**. See Section 4.8.5.3 below

4.8.5.1 Option “0=Normal” (Default). This option is also called “Off-Line UPS Mode” (UPS stands for **U**n-interruptible **P**ower **S**upply). In this mode, AC input from the source is the PRIMARY source of AC power and the batteries / Inverter Section of EVO is the BACK-UP source of DC-AC power. If qualified AC input (within the programmed voltage and frequency limits) is available, the EVO will operate in “Charging Mode” and qualified AC input will be passed through to the AC output and at the same time, the Internal AC Charger will start charging the batteries. If an external Solar Charge Controller is also connected to the External Charging Terminals (3, 4 in Fig 2.1), the internal AC Charger of EVO will limit the charging current as follows:

Value of charging current produced by EVO
Charging Section

=

(Programmed value of charging current set by parameter “BULK CURRENT” *[See Section 4.4.2.1 of EVO-RC Remote Control Manual attached at Appendix A]* **minus** (Value of current fed from the external solar charge controller)

SECTION 4 | General Description & Principles of Operation

When AC input fails or, is not within the programmed values of voltage and frequency, the unit will change over to "Inverting Mode" and the AC Output will be fed from the internal Inverter Section of EVO. When the AC input is restored, the EVO will revert back to "Charging Mode" to charge the batteries and at the same time, pass through the AC input to the AC output.

4.8.5.2 Option "1= On-Line": This option is also called "On-Line UPS Mode" (UPS stands for **U**n-interruptible **P**ower **S**upply). In this mode, the Inverter Section of the EVO is the PRIMARY DC-AC source of power. The AC input source is the BACK-UP source of AC power. In this mode, even if qualified AC input is available (within the programmed voltage and frequency limits), the EVO will still operate in "Inverting Mode" and AC output will be provided by the Inverter Section as long as the batteries are in charged condition above the specified programmed value of low battery voltage that is set through programmable parameter "LOW VOLT ALARM" [*See Section 4.4.2.8 of EVO-RC Remote Control Manual attached at Appendix A*]. When the battery discharges to the programmed voltage threshold of "LOW VOLT ALARM", or lower and remains at this threshold, or below for a sustained programmed time period set by programmable parameter "GS DETECT TIME" [*See Section 4.4.2.16 of EVO-RC Remote Control Manual attached at Appendix A*], the EVO will change over to "Charging Mode". On changing over to "Charging Mode", qualified AC input will be passed through to the AC Output and at the same time, the Internal AC Charger will start charging the battery. If an external Solar Charge Controller is also connected to the External Charging Terminals (3, 4 in Fig 2.1), the internal AC Charger will limit the charging current as follows:

$$\begin{array}{l} \text{Value of charging current produced by EVO} \\ \text{Charging Section} \end{array} = \begin{array}{l} \text{Programmed value of charging current set by} \\ \text{parameter "BULK CURRENT" [*See Section 4.4.2.1} \\ \text{of EVO-RC Remote Control Manual attached at} \\ \text{Appendix A*] minus (Value of current fed from the} \\ \text{external solar charge controller)} \end{array}$$

Under the following 2 conditions, "Charging Mode" will be terminated, and the EVO will switch back to "Inverting Mode". Switching from "Charging Mode" back to "Inverting Mode" has 2 options under programming parameter "ONLINE OPTION" [*See Section 4.4.2.14 of EVO-RC Remote Control Manual attached at Appendix A*]:

- i. When Parameter "**ONLINE OPTION**" is set at option "0= Option 1" [*See Section 4.4.2.14 in the EVO-RC Remote Control Manual attached at Appendix A*]:

EVO™ will switch back from "Charging Mode" to "Inverting Mode" after completion of 3-Stage/ 2-Stage charging profile programmed through parameter "CHARGING PROFILE" [*See Section 4.4.2.21 in the EVO-RC Remote Control Manual attached at Appendix A*]

- ii. When Parameter "**ONLINE OPTION**" is set at option "1= Option 2" [*See Section 4.4.2.4 in the EVO-RC Remote Control Manual attached at Appendix A*]:

EVO™ will switch back from "Charging Mode" to "Inverting Mode" when the batteries have charged to the voltage threshold set by parameter "RESET VOLTAGE" [*See Section 4.4.2.7 in the EVO-RC Remote Control Manual attached at Appendix A*] and have remained at this threshold or higher for time period set by parameter "GEN OFF DELAY" [*See Section 4.4.2.18 in the EVO-RC Remote Control Manual attached at Appendix A*].

SECTION 4 | General Description & Principles of Operation



INFO

Online Mode is suitable for installations where both Grid and Photovoltaic (PV) Solar Battery Charging System are available. It is also desirable in areas where Grid / Utility Energy Rates are very high and use of supplementary battery based photovoltaic power system is more cost effective.

4.8.5.3 Option "2=Charger Only".

In Off-grid DC powered homes, for efficiency consideration, all lighting and other loads / appliances are normally powered from batteries that are primarily charged through solar / wind power. Generator backup is used for powering AC to DC battery charger for charging the batteries during extended periods of cloudy / no wind conditions. To meet this requirement, the EVO™ can be programmed to operate as a battery charger ONLY i.e. when AC input power is available within the programmed limits of voltage and frequency, charging will take place and AC input will be passed through to the load(s). The unit will NOT transfer to Inverting Mode if AC input fails or is outside the programmed limits of voltage and frequency [For details, see Section 4.4.2.13.3 of EVO-RC Remote Control Manual attached at Appendix A].

4.9 TEMPERATURE SENSOR FOR BATTERY CHARGING

Battery Temperature Sensor Model EVO-BCTS [Fig 2.5(a)] has been provided to ensure optimum charging of Lead Acid/ Nickel-Zinc (Ni-Zn) batteries by modifying the charging voltages based on temperature if the battery sees very wide temperature swings. See Section 5.5 for details. Temperature compensation can be programmed with the help of optional Remote Control EVO-RC [See Section 4.4.2.5 of EVO-RC Remote Control Manual attached at Appendix A]. Range is -3 to -4 mv/ °C/cell (Default is -4 mv/ °C/cell). Without temperature compensation, the battery life is likely to be drastically reduced because the battery will be undercharged during cold conditions (will build up sulfation) or will be overcharged during hot conditions (will boil and lose excessive water). See Section 1.4.5 for more details on temperature compensation.



CAUTION!

1. Lithium Ion Battery charging does not require temperature compensation. Hence, do not use EVO-BCTS Temperature Sensor when charging Lithium Ion Batteries.
2. Automatic temperature compensation using EVO-BCTS Temperature Sensor is designed for Lead Acid Batteries based on programming parameter "COMPENSATE" [See Section 4.4.2.5 in EVO-RC Remote Control Manual attached at Appendix-A]. When charging Nickel-Zinc (Ni-Zn) batteries, ensure that the value of programming parameter "COMPENSATE" is set based on approximate linear compensation for the particular Ni-Zn battery.

SECTION 4 | General Description & Principles of Operation



ATTENTION!

1. Le chargement au lithium-ion ne nécessite pas de compensation de température. Par conséquent, n'utilisez pas le capteur de température EVO-BCTS lors du chargement de batteries au lithium-ion.
2. La compensation automatique de température à l'aide du capteur de température EVO-BCTS est conçue pour les batteries au plomb selon le paramètre de programmation "COMPENSATE" [voir la section 4.4.2.5 du manuel de la télécommande EVO-RC joint à l'annexe A]. Lors de la charge en nickel-zinc (Ni-Zn) batteries, assurez-vous que la valeur du paramètre de programmation "COMPENSATE" est définie sur la base d'une compensation linéaire approximative pour la batterie Ni-Zn concernée.

4.10 PARALLEL OPERATION WITH EXTERNAL SOLAR CHARGE CONTROLLER

The Battery Charger Section is able to operate in parallel with external Solar Charge Controller with a charging capacity of up to 50 A. The output of the external charging source is routed through this unit and operates in parallel with the internal charger. The internal charging current is controlled to ensure that the combined current fed to the battery does not exceed the programmed value of parameter "BULK CURRENT" [See Section 4.4.2.1 in the EVO-RC Remote Control Manual attached at Appendix-A]. This improves the life of the battery. Please see Section 5.4 for more details.

4.11 COOLING AND OVER TEMPERATURE PROTECTION

4.11.1 Cooling Fans

The unit is cooled by convection and by forced air cooling using 2 variable speed cooling fans. Temperature is sensed at the Power Transformer and H-Bridge Power Mosfets / Heat Sink. The fans will be switched ON at specified temperatures measured at the above sense points. The speed of the fans is increased as the temperature rises.

4.11.2 Over Temperature Protection

Refer to Fault Messages and Troubleshooting Guide at Table 7.1 of EVO-RC Remote Control Manual attached at Appendix A. The unit goes to Fault Mode and shuts down due to over temperature sensed at the Main Power Transformer and the Heat Sink for the Power Mosfets: Fault messages and temperature thresholds for shut down and auto-reset are as follows:

- **"Transformer over heat!"** : Shut down at 150°C and auto-reset at 80°C
- **"Heat sink over heat!"** : Shut down at 70°C and auto-reset at 40°C

4.11.3 Automatic Reduction Of Charging Current In Higher Ambient Temperatures

In order to protect against over temperature shut down when operating in higher ambient temperatures of 50C to 60C, the BULK CURRENT setting [See Section 4.4.2.1 in the EVO-RC Remote Control Manual attached at Appendix-A] is automatically reduced as follows based on temperature sensed at the Power Transformer and at the Heat Sink for the Power Mosfets:

- **Power Transformer:** In case the temperature is >130°C, the BULK CURRENT setting is automatically reduced by 4A (EVO-2212) / 20A (EVO-3012) / 1A (EVO-2224) / 5A (EVO-4024) every 10 sec

SECTION 4 | General Description & Principles of Operation

- **Heat Sink:** In case the temperature is $>65^{\circ}\text{C}$, the BULK CURRENT is automatically reduced by 4A (EVO-2212) / 20A (EVO-3012) / 1A (EVO-2224) / 5A (EVO-4024) every 10 sec

4.12 OPTIONAL REMOTE CONTROL EVO-RC FOR PROGRAMMING OF MODES OF OPERATION AND PARAMETERS

Optional Remote Control Model EVO-RC [Fig 2.4(a)] will be required for more advanced control and monitoring. *Please see separate Owner's Manual for EVO-RC attached at Appendix A.* The Remote Control comes with 10M / 33 ft., RJ-45 Data Cable. The Remote plugs into RJ-45 Jack on the front panel of the unit (7, Fig 2.1). It has provision for Data Logging using SD Card of up to 16 GB (FAT16 / FAT32). It also has its own Real Time Clock and Super Capacitor Type of Internal Battery. The Remote Control will be required for Firmware upgrade through the SD Card.

Detailed messaging is available through its LCD display and LEDs. This remote will also be required for programming of various parameters to suit specific requirements. Each programmable parameter has a Default Value. **This unit has been shipped with the various parameters set at the Default Values.** *Programmable and Default values are shown in Tables 6.2 to 6.6.*

SECTION 5 | Battery Charging in Evolution™ Series

5.1 PRINCIPLES OF OPERATION OF BATTERY CHARGING SECTION



INFO

For background information on batteries and charging process, please read Section 1.4, "General Information - Battery Related". All battery charging voltages are specified at battery temperature of 25°C / 77°F .

5.1.1 General Information

EVO Series is a Low Frequency Type, Pure Sine Wave, Single Phase Inverter-Charger with a built-in Transfer Relay. It uses high performance, 100MHz SP (Digital Signal Processing) type of micro-controller and Pulse Width Modulation (PWM) control. It is Bi-Directional i.e. it uses a common Converter Section consisting of Low Frequency Isolation Transformer and Mosfet based H-Bridge that can work in two directions as follows:

- 1) **AC to DC Charging Mode:** The common Converter Section is used to convert external AC input power from 2 sources (Grid or Generator or both) to DC output power to charge the batteries and at the same time, pass through the AC input power to the AC loads
- 2) **DC to AC Inverting Mode:** The common Converter Section is used to convert DC input power from the batteries to AC output power to feed the AC loads



INFO

Please note that as the unit is Bi-Directional with a common Converter Section as explained above, it cannot work as inverter and charger at the same time

SECTION 5 | Battery Charging in Evolution™ Series

During “Charging Mode”, the internal Transfer Relay is energized when AC input power from Grid / Generator is within the programmed limits of voltage and frequency and the following actions are initiated:

- AC input power is fed to the Common Converter Section for conversion to DC voltage to charge the batteries
- AC input power is simultaneously passed through to the AC loads

5.1.2 Basics of PWM (Pulse Width Modulation) Based Charging Process

5.1.2.1 AC input from Grid / Generator is fed to the Primary Winding of the Isolation Transformer. The voltage on the Secondary of the isolation Transformer is stepped down and fed to input of H-Bridge Converter that uses four N-Channel Mosfet Switches. The output of the H-Bridge is fed to the battery / battery bank. PWM (Pulse Width Modulation) technique is used for the charging process. PWM frequency is 30 kHz

5.1.2.2 The two High-Side Mosfet Switches of the H-Bridge are kept OFF and their Body Diodes are used for full-wave rectification of the stepped down AC input voltage. The average / mean value of battery charging current will vary between 0A and a Positive peak value in the form of DC Wave resembling sine wave. The charging current displayed by the EVO-RC Remote Control will be the average / mean value of the above DC Wave

5.1.2.3 The two Low-Side Mosfet Switches of the H-Bridge are switched ON / OFF together at PWM frequency of 30 kHz with variable “Duty Cycle” proportional to the desired value of charging current. When the two Low-Side Mosfets are ON for period determined by the “Duty Cycle” set by the micro-controller, the Secondary Winding will be short circuited and magnetic field proportional to the short circuit current will be created by the winding. When the two Low-Side Mosfet Switches are switched OFF, short circuit of the winding is removed resulting in collapse of the magnetic field and generation of induced voltage pulses at PWM frequency of 30 kHz with a value = $-L \frac{di}{dt}$ where “L” is the Inductance of the winding and “ $\frac{di}{dt}$ ” is the rate of decay of Short Circuit Current. Thus, higher Duty Cycle will produce induced pulses with higher voltage. When the voltage of the induced pulses is > the battery voltage, charging current pulses will be produced. The value of charging current pulses will be proportional to the difference of voltage between the voltage of the induced pulses and the battery voltage

5.1.2.4 During the Bulk Stage of charging (Section 5.7.1.1), the average / mean charging current set by programming parameter “BULK CURRENT” [See section 4.4.2.1 of EVO-RC Remote Control Manual attached at Appendix A] is held constant by controlling the “Duty Cycle” of the 30 kHz induced pulses.



INFO

When charging starts, the charging current is NOT increased to the programmed value of parameter BULK CURRENT immediately but is gradually ramped up to this value

5.1.2.5 During Absorption Stage (Section 5.7.2), Float Stage (5.7.3) and Equalization Stage (5.8.2.3), the battery voltage is held constant indirectly by controlling the “Duty Cycle” of the 30 kHz induced pulses. For example, if the battery voltage increases above the value set by parameters ABSORP VOLTAGE / FLOATING VOLTAGE / EQUALIZE VOLTAGE, the PWM “Duty Cycle” is reduced that leads to lower short circuit current of the Secondary Winding. This will reduce the voltage of the induced pulses and consequently, reduce the value of the charging current pulses. Reduced value of charging current pulses will reduce the battery voltage back to the value set by ABSORP VOLTAGE / FLOATING VOLTAGE / EQUALIZE VOLTAGE

SECTION 5 | Battery Charging in Evolution™ Series

5.1.2.6 Battery Charging Profiles

7 programmable types of 2/3/4 Stage Charging Profiles are available. Please see details under Section 5.6

5.2 DYNAMIC AC INPUT CURRENT DIVERSION CONTROL BETWEEN AC PASS THROUGH CURRENT AND BATTERY CHARGING CURRENT

EVO Models have very powerful Battery Charger Section that will require very high AC input current from the Grid / Generator (See Table 5.1).

	Rated Charging Current		Maximum Pass Through Load Power and Current	
	Max. DC Side Charging Current	Equivalent AC Side Charging Current	Pass Through Power	Pass Through Amps
EVO-3012	130A	20A	3000 VA	25A
EVO-2212	100A	15A	2200 VA	18A
EVO-4024	110A	30A	4000 VA	33A
EVO-2224	70A	19A	2200VA	18A

When batteries are being charged at or near the maximum value of charging current (See TABLE 5.1) and the pass through load current increases, the Grid / Generator supply circuit breaker may trip if the combined value of the AC side charging current (equivalent to the DC side charging current) and the pass through load current exceeds the Grid / Generator supply circuit breaker capacity. This situation is prevented by “Dynamic AC Input Current Diversion Control between AC Pass through Current and Battery Charging Current”. This is accomplished through appropriate setting of programmable parameters “GRID MAX CURRENT” / “GEN MAX CURRENT”. Optional Remote Control Model EVO-RC will be required for the above setting *[Please refer to Section 4.5.2.2 of the EVO-RC Remote Control Manual attached at Appendix A]*.

“GRID MAX CURRENT” / “GEN MAX CURRENT” (Default = 30A) should be set equal to the Ampere rating of the external Grid / Generator supply breakers. During Battery Charging Mode, if the AC pass through load current is increased resulting in the net AC input current increasing by 1A more than the programmed “GRID MAX CURRENT” / “GEN MAX CURRENT” for 1 sec, the **EVO will automatically reduce the charging current to ensure that the equivalent AC Side Charging Current + Pass Through Load Current is not more than the set value of “GRID MAX /GEN MAX CURRENT”.**

INFO

As explained above, if the net AC input current is 1A more than the value of GRID MAX CURRENT or GEN MAX CURRENT for 1 sec, the AC side charging current is clawed back to ensure that GRID MAX CURRENT / GEN MAX CURRENT value is not exceeded. If the value of pass through load current increases to a value of 1A more than the programmed value of GRID MAX CURRENT / GEN MAX CURRENT for 5 sec, input over current protection will be activated based on option to either transfer to Inverting Mode or to shut down in FAULT MODE *[Refer to details of these 2 options under parameter “INPUT OC PROTECT” at Section 4.5.2.10 in the EVO-RC Owner’s Manual attached at Appendix A]*

SECTION 5 | Battery Charging in Evolution™ Series

EXAMPLE:

- 1) Assume EVO-2212 is connected to the Grid input with Grid input supply circuit breaker capacity of 30A. Parameter settings are as follows:
 - a) "GRID MAX CURRENT" setting = the Default value of 30A.
 - b) "BULK CURRENT" setting = 100A (DC). When charging at 100A on the DC side, the corresponding AC side input current will be 15A (Based on Conversion Factor of 1A DC side charging current = 0.15A AC side charging current).
- 2) Assume that the AC pass-through load current is 10A. The total AC input current will be 25A i.e. 10A AC pass-through load current + 15A AC input side current corresponding to 100A DC side charging current [see 1(b) above]. Under this condition the EVO will operate normally because the net AC input current of 25A will be below 30A Default setting for parameter "GRID MAX CURRENT"
- 3) If now, the AC pass-through load current is increased to 25A for more than 5 sec, the total AC input current will be 40A i.e. 25A pass through load current + 15A AC side charging current corresponding to 100A DC side charging current [see 1(b) above]. As the total AC input current will be 10A more than the "GRID MAX CURRENT" for more than 1 sec, the AC input side charging current will be clawed back from 15A to 5A within less than 5 sec so that the total AC input current is limited to 30A. At reduced AC side charging current of 5A, the corresponding DC side charging current will be 33.3 A DC (Based on Conversion Factor of 1A DC side charging current = 0.15A AC side charging current).
- 4) If now, the AC pass-through load current is increased to 32A for more than 5 sec, the total AC input current will be 37A (32A pass through load current + 5A AC side charging current corresponding to 33.3A DC side charging current) . The AC side charging current will be automatically reduced from 5A (corresponding to 33.3A DC side charging current) to 0A (corresponding to 0A DC side charging current). However, now the AC input current will be still be 32A i.e. 2A more than the "GRID MAX" current setting of 30A for more than 5 sec. After 5 sec of operation under this condition, the EVO will operate as follows based the option selected through parameter "INPUT OC PROTECT" *[See details of this parameter under Section 4.5.2.10 in EVO-RC Owner's Manual attached at Appendix A]*
 - o **Parameter "INPUT OC PROTECT" set in the Default option "0=Inverter"**: The EVO will switch over to Inverter Mode to ensure that 32A AC load is maintained. If subsequently, the load reduces to 1A less than the 30A setting of GRID MAX CURRENT for 5 sec, the EVO will switch back to Charging Mode
 - o **Parameter "INPUT OC PROTECT" set for option "1= Shutdown": EVO will be shut down.**
 - There will be no AC output because the Transfer Relay will be de-energized, charging will be stopped and PWM drive to the Inverter Section will be switched off
 - Fault message "Input over current" will be displayed on the LCD screen, Green LED marked "Status" will be switched off and Red LED marked "Fault" will be switched on
 - **The unit will be latched in OFF condition and will require manual reset by powering off the unit, waiting for 1 min and then powering on again**

SECTION 5 | Battery Charging in Evolution™ Series

5.3 AUTOMATIC REDUCTION OF CHARGING CURRENT IN HIGHER AMBIENT TEMPERATURES

In order to protect against over temperature shut down when operating in higher ambient temperatures of around 50C to 60C, the BULK CURRENT setting [See section 4.4.2.1 of EVO-RC Remote Control Manual attached at Appendix A] is automatically reduced as follows based on temperature sensed at the Power Transformer and at the Heat Sink for the Power Mosfets:

- **Power Transformer:** In case the temperature is >130C, the BULK CURRENT setting is automatically reduced by (i) 4A every 10 sec for EVO-2212, (ii) 20A every 10 sec for EVO-3012, (iii) 1A every 10 sec for EVO-2224 and (iv) 5A every 10 sec for EVO-4024.
- **Heat Sink:** In case the temperature is >65C, the BULK CURRENT setting is automatically reduced by (i) 4A every 10 sec for EVO-2212, (ii) 20A every 10 sec for EVO-3012, (iii) 1A every 10 sec for EVO-2224 and (iv) 5A every 10 sec for EVO-4024.

5.4 PARALLEL CHARGING USING EXTERNAL SOLAR CHARGER

The batteries feeding the EVO™ can also be charged using appropriately sized external solar charging system. The output of the solar panels will feed to an appropriately sized external Solar Charge Controller. Output of the external Solar Charge Controller is fed to the input terminals marked "EXT Charger" (3,4 in Fig 2.1). **Maximum charging current on these terminals is to be limited to 50A. This limit should not be exceeded!**

The charging current received from the external Solar Charge Controller is directly fed to the battery terminals (1,2 in Fig 2.1) through a series connected Hall-effect Current Sensing IC with integrated shunt. The value of this current is displayed as "BATT EXT" on the optional Remote Control EVO-RC. Refer to following display screens from Fig 3.2 under Section 3.6.2 of EVO-RC Remote Control Manual attached at Appendix A.

- During Inverting Mode: Screen No. 9 under GROUP 2: INVERTING MODE screens
- During Charging Mode: Screen No. 16 under GROUP 3: CHARGING MODE
- During Power Save Mode: Screen No. 2 under GROUP 4: POWER SAVING MODE

The net Bulk Charging Current fed to the battery bank will, thus, be as follows:

- Net Bulk Charging Current fed to the battery bank= Adjusted Bulk Charging Current from the internal Battery Charging Section + Current available from the external Solar Charge Controller

Normally, Lead Acid batteries should not be charged at very high Bulk Charging Current as this will damage the batteries due to overheating and cell degradation. Normal Bulk Charging Current is in the range of 10% to 20% of the Ah capacity of the battery bank at C/20 Discharge Rate. Check with the battery manufacturer regarding recommended Bulk Charging Current for your battery bank. This value of "Bulk Charging Current" should be programmed as "BULK CURRENT" using the optional Remote Control EVO-RC [Refer to Section 4.4.2.1 in the attached Owner's Manual for EVO-RC at Appendix A].

The measured value of the charging current received from the external Solar Charge Controller is monitored by the control circuitry of the internal Battery Charging Section. The amount of Bulk Charging Current produced by the internal Battery Charging Section is adjusted in real time to satisfy the following condition:

- Internal Bulk Charging Current = Programmed Value of "Bulk Current" – External Charging Current
For example, if the "Bulk Current" in the EVO™ is programmed at say 40A and the external Solar Charge Controller is generating 15A, the internal Battery Charging Section will reduce its current from 40A to 25A so that the net charging current is equal to the programmed value of 40A.

SECTION 5 | Battery Charging in Evolution™ Series

In other Inverter Chargers where this design feature is not available and the Bulk Charging Current of the internal Battery Charger Section is fixed, the batteries are likely to be charged at high Bulk Charging Current = Fixed value of Bulk Charging Current from the internal Battery Charging Section + Current available from the External Charge Controller.



CAUTION!

Ensure that charging voltage related parameters of EVO™ like (i) ABSORP VOLTAGE, (ii) EQUALIZE VOLTAGE, (iii) FLOAT VOLTAGE and (iv) Temperature Compensation (COMPENSATE) are set / programmed to match the programmed parameters of the external charge controller. [Please refer to (i) Table 6.2, Section 6 and (ii) Sections 4.4.2.2 to 4.4.2.5 of the EVO-RC Remote Control Manual attached at Appendix A].



ATTENTION!

S'assurer que la charge de tension, les paramètres connexes d'EVO™ comme (i) La tension d'absorption, (ii) EQUALIZE VOLTAGE, (iii) Tension d'égaliser et (iv) La compensation de température (COMPENSATE) est réglée / programmée pour correspondre aux paramètres programmés du contrôleur de charge externe. [Veuillez consulter (i) le tableau 6.2, section 6 et (ii) les sections 4.4.2.2 à 4.4.2.5 du manuel d'utilisation de la télécommande EVO-RC-PLUS].

5.5 BATTERY TEMPERATURE COMPENSATION USING TEMPERATURE SENSOR: MODEL NO. EVO-BCTS

5.5.1 General Description – Battery Temperature Compensation

Please refer to Section 1.4.5 for general information on temperature compensation of battery charging voltages.

Battery Temperature Sensor Model EVO-BCTS [Fig 2.5(a)] has been provided to ensure optimum charging of Lead Acid and Nickel Zinc (Ni-Zn) Batteries by **negative** temperature compensation of the charging voltages based on the battery electrolyte temperature. The charging voltage is reduced when electrolyte temperature rises above the reference temperature of 25°C / 77°F and increased when electrolyte temperature falls below the reference temperature of 25°C / 77°F.



INFO

Charging voltages of Lithium Ion Battery are not affected by temperature and hence, Battery Temperature Sensor Model EVO-BCTS is not required to be used when Lithium Ion batteries are used.

SECTION 5 | Battery Charging in Evolution™ Series

Automatic temperature compensation will be carried out over temperature range of -20°C to $+60^{\circ}\text{C}$ based on the programmed value of the **negative** "Temperature Coefficient of Battery Charging Voltage". In EVO, this parameter is called "COMPENSATE" and is specified in "mV/C/Cell". For programming details of this parameter, please refer to the following Sections of EVO-RC Remote Manual attached at Appendix A:

- Parameter Setup Menu Map at Fig 4.1: Screen 5 against Column "GROUP 1 CHARGE CURVE"
- Programming range and defaults: Screen No. 5 of Table 4.1
- Programming procedure: Section 4.4.2.5

In addition to compensating Absorption, Float and Equalization voltages, the voltage thresholds of parameters "LOW VOLTAGE ALARM", "BATTERY LOW VOLTAGE", "RESET VOLTAGE", "BATTERY OVER VOLTAGE" and "RESET TO BULK" are also temperature compensated.

5.5.2 Constructional Details of Battery Temperature Sensor Model EVO-BCTS and Installation

The Temperature Sensor consists of 5 meters / 16.5 ft cable with Temperature Sensor Head for the battery end [1 in Fig 2.5(a)] and RJ-45 Plug [2 in Fig 2.5(a)] for EVO end.

Temperature Sensor Head [1 in Fig 2.5(a)]: The Temperature Sensor Head is installed on the Positive / Negative battery Stud [Fig 2.5(b)] to monitor the temperature of the battery electrolyte. The Sensor Head contains an embedded Negative Temperature Coefficient (NTC) Resistor with 2 internal terminals "NTC+" and "NTC -". Internal terminal "NTC+" is wired to Pin 4 of the RJ-45 Plug [2 in Fig 2.5(a)] and internal terminal "NTC -" is wired to Pin 5 of the RJ-45 Plug.

RJ-45 Plug [2 in Fig 2.5(a)]: The RJ-45 Plug is required to be plugged into the RJ-45 Jack marked "Battery Temp Sensor" on the front panel of EVO (6 in Fig 2.1). Pinout of this RJ-45 Jack is shown in Fig 5.0.

RJ-45 Jack on the Front Panel of EVO™ (6, Fig 2.1) for Connecting Battery Temperature Sensor

Pinout of this RJ-45 Jack [marked "Battery Temp Sensor" on the front panel of EVO (6 in Fig 2.1)] is shown at Fig 5.0 below (also shown at Fig 3.13):

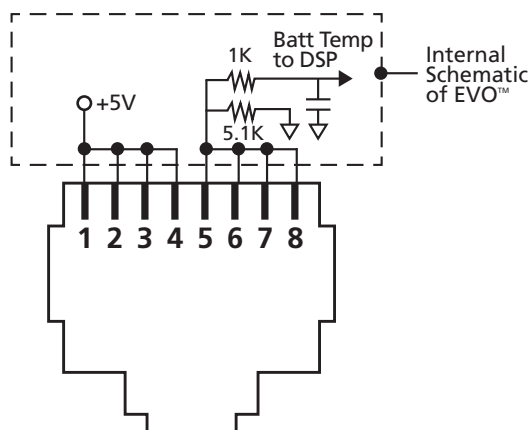

Fig 5.0 Pinout of RJ-45 Jack marked "Battery Temp Sensor" on the front panel of EVO (6 in Fig 2.1).

SECTION 5 | Battery Charging in Evolution™ Series

5.6 CHARGING PROFILES

Please refer to Section 1.4.3 regarding general information on 4 stages of battery charging. Depending upon the type of batteries to be charged and its application, 2/3/4 charging stages may be used based on the appropriate Charging Profile.

When AC input within the programmed window of voltage and frequency is available, EVO will operate as a battery charger. Option is available for 7 charging profiles as follows:

- 6 options for the following 3-Stage / 2-Stage charging profiles through programming parameter “CHARGING PROFILE” designed to cover various charging requirements for Lead Acid, Nickel-Zinc (Ni-Zn) and Lithium Ion Batteries.

- 0 = 3 Stage Adaptive (Default)
- 1 = 3 Stage Type 1
- 2 = 3 Stage Type 2
- 3 = 2 Stage Type 1
- 4 = 2 Stage Type 2
- 5 = 2 Stage Type 3



Refer to the following for more details:

- Section 5.7 for description and charging curves for 3-Stage Charging Profiles
- Section 5.10 for description and charging curves for 2-Stage Charging Profiles
- [Programming procedure at Section 4.4.2.21 in the EVO-RC Remote Control Manual attached at Appendix A](#)

- 1 option for 4-Stage Adaptive Charging Profile for Equalization for Lead Acid Batteries



Refer to the following for more details:

- Section 5.8 for description and charging profiles
- [Programming procedure at Section 4.4.2.12 in the EVO-RC Remote Control Manual attached at Appendix A](#)



CAUTION!

The Battery Management System (BMS) that comes with the type of Lithium Battery being used may need to have control over charging and discharging of the battery. For this, Pins 4 and 5 of the Temperature Sensor Jack (6, Fig 2.1; Pinout at Fig 5.0) may be used to feed potential free contact closing signal from the BMS to “Stop Charging” or “Stop Inverting” Refer to Section 5.11.2 for details.



ATTENTION!

Le système de gestion de la batterie (BMS) qui vient avec le type de batterie au lithium utilisé aura besoin d'avoir le contrôle de charge et décharge de la batterie. Pour cela, les broches 4 et 5 du capteur de température (6, Fig. 2.1; Pinout à la Fig. 5.0) peut être utilisé pour l'alimentation contact libre de signal de fermeture de la BMS à "arrêter la charge" ou "arrêter d'inverser". Se reporter à la Section 5.11.2 pour plus de détails.

SECTION 5 | Battery Charging in Evolution™ Series

5.7 3-STAGE CHARGING PROFILE - DETAILED EXPLANATION

Refer to 3 types of 3-Stage Charging Profile options at Srls. 1 to 3 in TABLE 5.2.

Fig. 5.1 shows the voltage and current charging curves with respect to time and different charging stages associated with these profiles.



INFO

4-Stage Adaptive Charging Profile for Equalization is also available and can be activated at any time during charging taking place under these 3-stage profiles. *Procedure to activate 4-Stage Adaptive Charging Profile for Equalization is described under programming parameter "EQUALIZE-4 STAGES" at Section 4.4.2.12 in the EVO-RC Remote Control Manual attached at Appendix A.*

SECTION 5 | Battery Charging in Evolution™ Series

TABLE 5.2 3 TYPES OF CHARGING PROFILE OPTIONS FOR 3-STAGE CHARGING

Srl No.	Options under Programming Parameter "CHARGING PROFILE" <i>(See Section 4.4.2.21 in EVO-RC Remote Control Manual attached at Appendix A)</i>	Charging Stages	Battery Type
1	<p>0 = 3 Stage Adaptive</p> <p><i>(Displayed as "0=3 Stg Adaptiv" in programming screen)</i></p> <p>NOTES:</p> <p>1.This is the default, <i>3-Stage Adaptive Type of Charging Profile with Adaptive Time Algorithm for Absorption Stage</i></p>	<ol style="list-style-type: none"> Stage 1 – Bulk Stage <i>(See Section 5.7.1.1 for details)</i> <ul style="list-style-type: none"> Charge at constant current (CC) = the programmed value of parameter "BULK CURRENT" (Default value is 40A. <i>For details of programming range & procedure, refer to Section 4.4.2.1 of EVO-RC Remote Control Manual attached at Appendix A</i>) Transition to Absorption Stage when voltage rises to the set value for programming parameter "ABSORP VOLTAGE" (Default value is 14.4V for EVO-2212/3012 and 28.8V for EVO-2224/4024. <i>For details of programming range & procedure, refer to Section 4.4.2.2 of EVO-RC Remote Control Manual attached at Appendix A</i>) Stage 2 - Absorption Stage <i>(See Section 5.7.2 for details)</i> <ul style="list-style-type: none"> Charge at constant voltage (CV) = the programmed value for parameter "ABSORP VOLTAGE". (Default value is 14.4V for EVO-2212/3012 and 28.8V for EVO-2224/4024. <i>For details of programming range & procedure, refer to Section 4.4.2.2 of EVO-RC Remote Control Manual attached at Appendix A</i>) Adaptive Time Algorithm: Time in Absorption Stage is computed automatically based on time in Bulk Stage <i>(See Section 5.7.2 for details)</i>. Transition to Float Stage thereafter. Stage 3 - Float Stage <i>(See Section 5.7.3 for details)</i> <ul style="list-style-type: none"> Charge at constant voltage (CV) = the programmed value of parameter "FLOATING VOLTAGE". (Default value is 13.5V for EVO-2212/3012 & 27.0V for EVO-2224/4024. <i>For details of programming range & procedure, refer to Section 4.4.2.4 of EVO-RC Remote Control Manual at Appendix A</i>) Reset to Bulk Stage under the following conditions: <ol style="list-style-type: none"> If the AC input from the Grid/Generator is disconnected and is reconnected. If battery voltage falls to the programmed value of parameter "RESET TO BULK" (Default value is 12.0V for EVO-2212/3012 & 24.0V for EVO-2224/4024. <i>For details of programming range & procedure, refer to Section 4.4.2.15 of EVO-RC Remote Control Manual at Appendix A</i>). If the charger remains in the Float Stage for 10 days 	<ul style="list-style-type: none"> Lead Acid: Flooded and sealed – AGM/Gel Cell ENSURE that there are no other DC load(s) on the batteries. Load(s) on the battery may drain full or part of the charging current and will upset the "Adaptive Time Algorithm" for Absorption Stage time
2	<p>1 = 3 Stage Type 1</p>	<ol style="list-style-type: none"> Stage 1 – Bulk Stage <i>(See Section 5.7.1.1 for details)</i> <ul style="list-style-type: none"> Charge at constant current (CC) = the programmed value of parameter "BULK CURRENT" (Default value is 40A. <i>For details of programming range & procedure, refer to Section 4.4.2.1 of EVO-RC Remote Control Manual at Appendix A</i>) Transition to Absorption Stage when voltage rises to the set value for programming parameter "ABSORP VOLTAGE" (Default value is 14.4V for EVO-2212/3012 and 28.8V for EVO-2224/4024. <i>For details of programming range & procedure, refer to Section 4.4.2.2 of EVO-RC Remote Control Manual at Appendix A</i>) Stage 2 - Absorption Stage <i>(See Section 5.7.2 for details)</i> <ul style="list-style-type: none"> Charge at constant voltage (CV) = the programmed value for parameter "ABSORP VOLTAGE". (Default value is 14.4V for EVO-2212/3012 and 28.8V for EVO-2224/4024. <i>For details of programming range & procedure, refer to Section 4.4.2.2 of EVO-RC Remote Control Manual at Appendix A</i>) Remain in Absorption Stage for time duration = programmed value of parameter "ABSORP TIME" (Default value is 60 min. <i>For details of programming range & procedure, refer to Section 4.4.2.19 of EVO-RC Remote Control Manual at Appendix A</i>) Transition to Float Stage thereafter. 	<ul style="list-style-type: none"> Lead Acid: Flooded and sealed – AGM/Gel Cell Lithium <i>(See Section 5.11 for details)</i>

SECTION 5 | Battery Charging in Evolution™ Series

		<p>3. Stage 3 - Float Stage (See Section 5.7.3 for details)</p> <ul style="list-style-type: none"> Charge at constant voltage (CV) = the programmed value of parameter "FLOATING VOLTAGE". (Default value is 13.5V for EVO-2212/3012 & 27.0V for EVO-2224/4024. For details of programming range & procedure, refer to Section 4.4.2.4 of EVO-RC Remote Control Manual at Appendix A) Reset to Bulk Stage under the following conditions: <ul style="list-style-type: none"> i. If the AC input from the Grid/Generator is disconnected and is reconnected. ii. If battery voltage falls to the programmed value of parameter "RESET TO BULK" (Default value is 12.0V for EVO-2212/3012 & 24.0V for EVO-2224/4024. For details of programming range & procedure, refer to Section 4.4.2.15 of EVO-RC Remote Control Manual at Appendix A). iii. If the charger remains in the Float Stage for 10 days 	
3	2 = 3 Stage Type 2	<p>1. Stage 1 – Bulk Stage (See Section 5.7.1.1 for details)</p> <ul style="list-style-type: none"> Charge at constant current (CC) = the programmed value of parameter "BULK CURRENT" (Default value is 40A. For details of programming range & procedure, refer to Section 4.4.2.1 of EVO-RC Remote Control Manual attached at Appendix A) Transition to Absorption Stage when voltage rises to the set value for programming parameter "ABSORP VOLTAGE" (Default value is 14.4V for EVO-2212/3012 and 28.8V for EVO-2224/4024. For details of programming range & procedure, refer to Section 4.4.2.2 of EVO-RC Remote Control Manual attached at Appendix A) <p>2. Stage 2 - Absorption Stage (See Section 5.7.2 for details)</p> <ul style="list-style-type: none"> Charge at constant voltage (CV) = the programmed value for parameter "ABSORP VOLTAGE". (Default value is 14.4V for EVO-2212/3012 and 28.8V for EVO-2224/4024. For details of programming range & procedure, refer to Section 4.4.2.2 of EVO-RC Remote Control Manual attached at Appendix A) Remain in Absorption Stage till the current reduces to value = the programmed value of parameter "ABSORP EXIT AMPS" (Default value is 4A. For details of programming range & procedure, refer to Section 4.4.2.20 of EVO-RC Manual at Appendix A) Transition to Float Stage thereafter. <p>3. Stage 3 - Float Stage (See Section 5.7.3 for details)</p> <ul style="list-style-type: none"> Charge at constant voltage (CV) = the programmed value of parameter "FLOATING VOLTAGE". (Default value is 13.5V for EVO-2212/3012 & 27.0V for EVO-2224/4024. For details of programming range & procedure, refer to Section 4.4.2.4 of EVO-RC Remote Control Manual at Appendix A) Reset to Bulk Stage under the following conditions: <ul style="list-style-type: none"> i. If the AC input from the Grid/Generator is disconnected and is reconnected. If battery voltage falls to the programmed value of parameter "RESET TO BULK" (Default value is 12.0V for EVO-2212/3012 & 24.0V for EVO-2224/4024. For details of programming range & procedure, refer to Section 4.4.2.15 of EVO-RC Remote Control Manual at Appendix A). <ul style="list-style-type: none"> ii. If the charger remains in the Float Stage for 10 days 	<ul style="list-style-type: none"> – Lead Acid: Flooded and sealed – AGM/Gel Cell – Lithium (See Section 5.11 for details)

5.7.1.1 STAGE 1 – Bulk Charge Stage

Refer to Fig 5.1 and Srl No. 1 of TABLE 5.2

During the 1st Bulk Charge Stage, the Duty Cycle of the boosted high frequency PWM voltage pulses (Section 5.1.2) is adjusted continuously to charge the battery at constant current (CC) = the programmed value of parameter "BULK CURRENT" designated as "Io" (Default value is 40A. For details of programming range & procedure for parameter "BULK CURRENT", refer to Section 4.4.2.1 of EVO-RC Remote Control Manual attached at Appendix A)

NOTE: The current will slowly ramp up to the programmed value of "BULK CURRENT"

SECTION 5 | Battery Charging in Evolution™ Series

This current is delivered to the batteries until the battery voltage approaches its Gassing Voltage i.e. Absorption Voltage which is typically around 14.4 volts for 12 volt batteries and 28.8 volts for 24 volt batteries. The desired value can be programmed using the optional Remote Control EVO-RC [Refer to parameter "ABSORP VOLTAGE" in Table 6.2 and at Section 4.4.2.2 of EVO-RC manual attached at Appendix A]. The Bulk Charge Stage restores about 75% of the battery's charge. The Gassing Voltage is the voltage at which the electrolyte in the battery begins to break down into Hydrogen and Oxygen gases. Under normal circumstances, a battery should not be charged at a voltage above its Gassing Voltage since this will cause the battery to lose electrolyte and dry out over time.

This stage is displayed as "X-CC" in the 1st line, right corner of the Charging Mode screens in the Remote Control EVO-RC. Refer to the screens shown under column – "GROUP 3: CHARGING MODE" in Fig 3.2 of EVO-RC Remote Control Manual attached at Appendix A. Character "X" denotes code for the Charging Profile that is active. (For details of codes, please see Table 3.2 under Section 3.6.2 of EVO-RC Remote Control Manual attached at Appendix A).

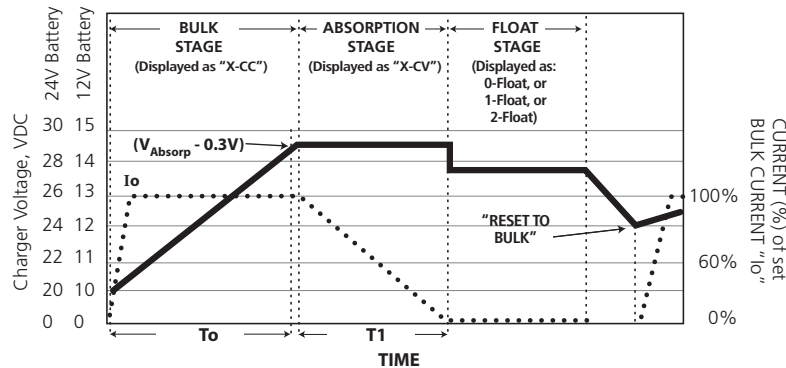

LEGEND for Fig 5.1	
	Voltage (V) Curve
	Current (I) Curve
I_o	Bulk Stage Current. <i>Please see Section 5.7.1.1</i>
T_o	Bulk Stage Time. <i>Please see Section 5.7.1.1</i>
T_1	Time in Absorption Stage. <i>Please see Section 5.7.2</i>
X-CC, X-CV, X-FLOAT	This coded information relates to the active Charging Profile and Charging Stage and is displayed in the right corner of the Charging Mode Display Screens of EVO-RC Remote Control. <i>Please see Table 3.2 under Section 3.6.3 of EVO-RC Remote Control Manual attached at Appendix A</i>
RESET TO BULK	At this point, the charger is forced to reset automatically from the operating charging stage and restart the selected CHARGING PROFILE from the 1st Stage i.e. from the Bulk Stage. <i>Please see Section 5.7.4</i>

NOTES for Fig 5.1	
1.	Voltage (V) and Current (I) curves show the battery voltage and current.
2.	The Voltage (V) and Current (I) curves shown are based on the following operating conditions: <ul style="list-style-type: none"> a) The battery is being charged exclusively by the Battery charging Section of EVO and that there is NO external charging source that is charging the battery / battery bank b) There is no external DC load on the battery / battery bank (the entire current delivered by the Charging Section of EVO is being used to charge the battery / battery bank)

Fig 5.1 Charging Curves for 3-Stage Charging Profile

SECTION 5 | Battery Charging in Evolution™ Series

The value of the "BULK CURRENT" ("Io") depends upon the total Ampere Hour (Ah) capacity of the battery or bank of batteries. A battery should never be charged at very high charging current as very high rate of charging will not return the full 100 percent capacity as the Gassing Voltage rises with higher charging current. **As a general Rule of Thumb, the BULK CURRENT "Io" for Lead Acid Batteries should be limited to 10% to 20% of the Ah capacity of the battery [Ah capacity at C-rate of discharge = C/20 (or, 0.05C)].** Higher charging current may be used for Lead Acid Batteries if permitted by the battery manufacturer. Lithium Ion & Nickel Zinc batteries may be charged at higher rates of up to 50% to 100% of their Ah capacity.

Programming range and Default values of "BULK CURRENT" ("Io") are shown in Table 6.2 and also at Table 4.1 under Section 4.4.1 of EVO-RC Remote Control Manual attached at Appendix A. The units are shipped with the "BULK CURRENT" set at the Default Value of 40A. For programming information for this parameter, please refer to Section 4.4.2.1 of EVO-RC Remote Control Manual attached at Appendix-A.

When the unit enters Charging Mode, it starts working as a battery charger and the charger will ramp up to full programmed "BULK CURRENT" until the charger reaches the programmed threshold of "ABSORP VOLTAGE".
NOTE: The charging current will slowly ramp up to the programmed value of BULK CURRENT.

For Adaptive Charging Profile Option "0=3 Stage Type 0" (See Srl. No. 1 in Table 5.2), a software timer will measure the time taken from the instant the unit enters the Bulk Charging Stage until the instant the battery voltage reaches 0.3V below the programmed "ABSORP VOLTAGE", then registers this time as Bulk Charge Time "To" and computes Absorption Time "T1" as 10 times the Bulk Charge Time "To" in the internal "T1 Timer" i.e. $T1 = To \times 10$ (Minimum value of "T1" is 1 Hr and max value is 12 Hrs). The "T1 Timer" is used to determine the time the charging will take place in the next Absorption Stage (Section 5.7.2).

5.7.1.2 Automatic Adjustments of Internal AC Charger Current When External Solar Charge Controller is Also Charging in Parallel

Please note that if an external Solar Charge Controller is also used to charge the batteries at the same time in parallel with the internal AC charger of the unit, the charging current of the internal AC charger will be controlled so that the total charging current of the external Solar Charge Controller and the internal charger is = the programmed "BULK CURRENT" ("Io").

For example, if the programmed "BULK CURRENT" ("Io") is say 40A and the charging current of the external Solar Charge Controller is 30A, the internal AC charger will output only 10A (Programmed setting of 40A – external charging current of 30A = 10A). Similarly, if the programmed setting is say 30A and the current supplied by the external Solar Charge Controller is say 50A, the internal AC charger will NOT provide any charging current.

Please refer to Section 5.4 for more details.

5.7.2 STAGE 2 – Absorption Stage

During the Absorption Stage, the Duty Cycle of the boosted high frequency PWM voltage pulses (Section 5.1.2) is adjusted continuously to keep the battery at constant voltage (CV) = the programmed value of parameter "ABSORP VOLTAGE" to ensure that the battery is further charged to the full capacity without overcharging. Programming range and Default values of "ABSORP VOLTAGE" are shown in Table 6.2. Default value is 14.4V for EVO-2212 / EVO-3012 and 28.8V for EVO-2224 / EVO-4024. For programming details of parameter "ABSORP VOLTAGE", refer to Section 4.4.2.2 of the EVO-RC manual attached at Appendix A. The Absorption Stage restores the remaining 25% of the battery's charge. The time the charger remains in the Absorption Stage is proportional to the depth of discharge of the battery. When the battery is more discharged, it will take longer time in the Bulk Charge Stage to reach the Gassing / Absorption Voltage.

SECTION 5 | Battery Charging in Evolution™ Series

For 3-Stage Adaptive Charging Profile Option "0=3 Stage Adaptive" (See Srl. No. 1 in Table 5.2), T1 Timer (explained under Bulk Stage in Section 5.7.1.1 and Fig 5.1) computes the time of charging in this stage as follows:

- Absorption Time "T1" = Bulk Charge Time "To" x 10 ("To" = Time from entering Bulk Charge Stage till battery voltage rises to 0.3V below Absorption Voltage).
- The "T1 Timer" has minimum time of 1 hour and a maximum time of 12 hours.
- When the "T1 Timer" runs out, the charger will enter the next Float Stage.
- Programming range and Default values of Absorption Voltage are shown in Table 6.2.

For the other 3-Stage Charging Profiles, "Stage 2 - Absorption Stage" is controlled as follows:

- Option "1 = 3 Stage Type 1" (See Srl. 2 of Table 5.2)
- Option "2 = 3 Stage Type 2" (See Srl. 3 of Table 5.2)

This stage is displayed as "X-CV" in the 1st line, right corner of the Charging Mode screens in the Remote Control EVO-RC. *[Refer to the screens shown under column "GROUP 3: CHARGING MODE" in Fig 3.2 of EVO-RC Remote Control Manual attached at Appendix-A. Character "x" denotes code for the Charging Profile that is active. For details of codes for the Charging Profiles, please see Table 3.2 under Section 3.6.2 of Owner's Manual for EVO-RC attached at Appendix A.]*

5.7.3 STAGE 3 – Float Stage

Float Stage is a maintenance stage in which the Duty Cycle of the boosted high frequency PWM voltage pulses (Section 5.1.2) is adjusted continuously to keep the battery voltage at level = the programmed parameter "FLOATING VOLTAGE", typically about 13.5V for 12V models and 27.0V for 24V models to maintain the battery's charge without losing electrolyte through gassing and also, prevent corrosion of Positive plate by maintaining proper Positive Plate Polarization Voltage. Programmable range of values of "FLOATING VOLTAGE" are shown in Table 6.2. Default value is 13.5V for EVO-2212 / EVO-3012 and 27.0V for EVO-2224 / EVO-4024. *For programming of parameter "FLOATING VOLTAGE", refer to Section 4.4.2.4 of EVO-RC Remote Control Manual attached at Appendix A.*

This stage is displayed as "X-FLOAT" in the 1st line, right corner of the Charging Mode screens in the Remote Control EVO-RC *[Refer to the screens shown under column "GROUP 3: CHARGING MODE" in Fig 3.2 of EVO-RC Remote Control Manual at Appendix A]. Character "x" denotes code for the Charging Profile that is active. [For details of the codes, please see Table 3.2 under Section 3.6.2 of Owner's Manual for EVO-RC attached at Appendix A].*

5.7.4 Automatic Resetting of Charging Cycle

The charging cycle will be reset to the Bulk Stage *[Section 5.8.2.1]* as follows:

- a) If the AC input from the Grid/Generator is disconnected and is reconnected
- b) If battery discharges and its voltage falls to the voltage level set by programming parameter "RESET TO BULK" *[For details, refer to Section 4.4.2.15 of EVO-RC Remote Control Manual attached at Appendix A].*
Programming range for this parameter is:
 - i. 10 to 13VDC for EVO-2212 / EVO-3012 (Default value is 12.0VDC)
 - ii. 20 to 26VDC for EVO-2224 / EVO-4024 (Default value is 24.0VDC)
- c) If the charger remains in the Float Stage for 10 days

SECTION 5 | Battery Charging in Evolution™ Series

5.8 4 STAGE ADAPTIVE CHARGING PROFILE - EQUALIZATION



CAUTION!

4-Stage Adaptive Charging Profile - Equalization should be used only for vented, flooded (non-sealed or "wet") batteries and not on sealed AGM / Gel Cell / Nickel-Zinc (Ni-Zn) / Lithium batteries and only as often as recommended by the battery manufacturer.



ATTENTION!

Profil de charge adaptative en 4 étapes - L'égalisation ne doit être utilisée que sur des batteries ventilées (non scellées ou «humides») et non sur des batteries scellées AGM / Gel / Nickel-Zinc (Ni-Zn) / Lithium et seulement aussi souvent que recommandé par le fabricant de batteries.

5.8.1 Brief Description:

4-Stage Adaptive Charging Profile for Equalization is used to equalize Flooded / Wet Cell Lead Acid Batteries. Equalization is carried out periodically – normally once per month for battery under heavy duty service and every 2 to 4 months for battery under light duty service. During the Equalization Stage, the battery is intentionally over-charged / boiled for a specified time period to equalize voltage of individual cells. Other benefits include reduction in sulfation and stirring up of the electrolyte to remove stratification. This results in maintaining the peak capacity of the battery.



INFO

Please read Section 1.4.4 regarding more details on necessity of equalizing batteries.

This 4-Stage Adaptive Charging Profile can be activated as follows:

- Using optional Remote Control Model EVO-RC. Programming Parameter "EQUALIZE-4STAGES" is required to be set at "1=Yes". *Refer to Section 4.4.2.12 of EVO-RC Manual attached at Appendix A.*
- If Remote Control EVO-RC is not available, by pressing On/Off Push Button on the front panel of the EVO (11, Fig 2.1) for 1 sec. The cycle can be stopped prematurely by pressing the On/Off Push Button for 1 sec. Please refer to Section 5.9 for more details.

5.8.2 4-Stage Adaptive Charging Profile for Equalization – Charging Curves

Fig 5.2 shows the voltage and current curves during the 4 stages under this profile. Details are explained below:

As part of this **Adaptive Equalization Algorithm**, the charging process in the Equalization Stage is based on time "**To**" which is the time the charger remains in the initial Constant Current Bulk Charging Stage. In the Bulk Charging Stage, charging takes place at constant current (referred to as "CC" at programmed value of parameter "BULK CURRENT" *[See Section 4.4.2.1 of EVO-RC Remote Control Manual attached at Appendix A]*). The charger will remain in the initial Bulk Charging Stage for a longer duration when the battery is deeply discharged and for a shorter duration if the battery has a shallow discharge.

SECTION 5 | Battery Charging in Evolution™ Series

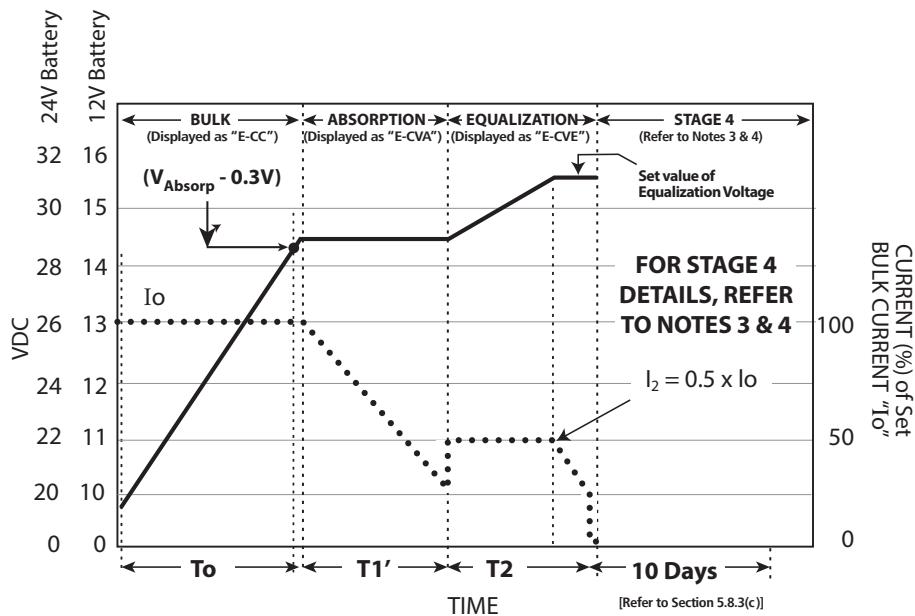

LEGEND for Fig 5.2	
	Voltage (V) Curve
	Current (I) Curve
I₀	Bulk Stage Current. <i>Please see Section 5.7.1.1</i>
T₀	Bulk Stage Time. <i>Please see Section 5.7.1.1</i>
T1'	Adaptive Time in Absorption Stage. <i>Refer to Section 5.8.2.1.2(a)</i>
T2	Adaptive Time in Equalization Stage. <i>Refer to Section 5.8.2.1.2(b)</i>
E-CC, E-CVA, E-CVE	This coded information relates to the active Charging Profile and Charging Stage and is displayed in the right corner of the Charging Mode Display Screens of EVO-RC Remote Control. <i>Please see Table 3.2 under Section 3.6.3 of EVO-RC Remote Control Manual attached at Appendix A</i>

NOTES for Fig 5.2	
1.	Voltage (V) and Current (I) curves show the battery voltage and current.
2.	Voltage (V) and Current (I) curves shown are based on the following operating conditions: <ul style="list-style-type: none"> a) The battery is being charged exclusively by the Battery charging Section of EVO and that there is NO external charging source that is charging the battery / battery bank b) There is no external DC load on the battery / battery bank (the entire current delivered by the Charging Section of EVO is being used to charge the battery / battery bank)
3.	The 4 th Stage will be the same as the last stage of the parameter CHARGING PROFILE [See Section 4.4.2.21 in the EVO-RC Remote Control Manual attached at Appendix A] from where Equalization was started. See Section 5.8.2.4 for details.
4.	See Section 5.8.3 regarding conditions under which the charger will be forced to reset automatically and restart charging in the 1 st Stage i.e. from the Bulk Stage of the programmed parameter CHARGING PROFILE [See Section 4.4.2.21 in the EVO-RC Remote Control Manual attached at Appendix A]

Fig 5.2 Charging Curves for 4-Stage Adaptive Charging Profile for Equalization

SECTION 5 | Battery Charging in Evolution™ Series

5.8.2.1 Stage 1 – Bulk Charge Stage

Refer to Section 1.4.3.1 for general information on Bulk Charge Stage and to Fig 5.2 for voltage and current curves during this stage.

5.8.2.1.1 During the 1st “Bulk Charge Stage”, the batteries will be charged at constant current (CC) = the programmed value of parameter “BULK CURRENT” (“Io”) [Default value of Parameter “BULK CURRENT” is 40A. See programming range at Table 6.2 and programming procedure at Section 4.4.2.1 in the EVO-RC Remote Control Manual attached at Appendix A]. The value of programmed parameter “BULK CURRENT” (“Io”) should normally be limited to 10% to 20% of the Ah capacity of the battery [Ah capacity at C-rate of discharge = C/20 (or, 0.05C)]. Higher current may be used if permitted by the battery manufacturer. The Bulk Charge Stage is displayed as “E-CC” in the right corner of the 1st line of Charging Mode Screens of EVO-RC Remote Control. [Please refer to codes / abbreviations in Table 3.2 under Section 3.6.2 of EVO-RC Remote Control Manual at Appendix A.]

5.8.2.1.2 A Software Timer is used to measure the time taken from the time the unit enters Bulk Stage to the time the battery voltage reaches 0.3V below the programmed value of parameter “ABSORP VOLTAGE” [Default value of parameter “ABSORP VOLTAGE” is 14.4V for EVO-2212/3012 and 28.8V for EVO-2224/4024. See programming range at Table 6.2, Section 6 and programming procedure at Section 4.4.2.2 in the EVO-RC Remote Control Manual attached at Appendix A]. This time is registered as Bulk Stage Time “To”. **As part of Adaptive Algorithm, the following times are computed based on the Bulk Stage Time “To”**

a) **Absorption Stage Time T1'** = To x 0.5

b) **Equalization Stage Time T2:**

- i. $T2 = T1' + 1 \text{ Hr} = (\text{To} \times 0.5) + 1 \text{ Hr}$; if T1' is <2 Hrs
- ii. $T2 = T1' + 2 \text{ Hrs} = (\text{To} \times 0.5) + 2 \text{ Hr}$; if T1' is > 2 Hrs but <4 Hrs
- iii. $T2 = T1' + 4 \text{ Hrs} = (\text{To} \times 0.5) + 4 \text{ Hr}$; if T1' is > 4 Hrs

5.8.2.1.3 When the battery voltage rises to the programmed value of parameter “ABSORP VOLTAGE”, the charging stage transitions to the next Stage 2 – Absorption Stage described at Section 5.8.2.2 below [Default value of parameter “ABSORP VOLTAGE” is 14.4V for EVO-2212/3012 and 28.8V for EVO-2224/4024. See programming range at Table 6.2, Section 6 and programming procedure at Section 4.4.2.2 in the EVO-RC Remote Control Manual attached at Appendix A].

5.8.2.1.4 Automatic Adjustment of Internal AC Charger Current when External Solar Charge Controller is also Charging in Parallel: Please note that if an external solar charge controller is also used to charge the batteries at the same time in parallel with the internal AC charger of the unit, the charging current of the internal AC charger will be controlled so that the total charging current of the external charger and the internal charger is = the programmed “BULK CURRENT (“Io”) [See Section 4.4.2.1 of EVO-RC Remote Control Manual at Appendix A.]

For example, if the programmed value of parameter “BULK CURRENT” (“Io”) is say 40A and the charging current from the external Solar Charge Controller is say 30A at any given instant, the internal AC charger will output only 10A (Programmed value of 40A minus external charging current of 30A = 10A). Now, if the charging current from the External Charge Controller rises to say 50A, the internal AC charger will be reduced to 0A.

5.8.2.2 Stage 2 – Adaptive Absorption Stage

Refer Section 1.4.3.2 for general information on Absorption Stage and to Fig 5.2 for voltage and current curves during this stage.

SECTION 5 | Battery Charging in Evolution™ Series

5.8.2.2.1 During the 2nd “Absorption Stage”, the batteries will be charged at constant voltage (CV) = the programmed value of parameter “ABSORP VOLTAGE” [Default value of parameter “ABSORP VOLTAGE” is 14.4V for EVO-2212/3012 and 28.8V for EVO-2224/4024. See programming range at Table 6.2, Section 6 and programming procedure at Section 4.4.2.2 in the EVO-RC Remote Control Manual attached at Appendix A]. The Absorption Stage is displayed as “E-CV” in the right corner of the 1st line of Charging Mode Screens of EVO-RC Remote Control. [Please refer to codes / abbreviations detailed at Table 3.2 under Section 3.6.2 of EVO-RC Remote Control Manual at Appendix A]. The charger remains in this stage for computed Time **T1** [Refer to Section 5.8.2.1.2(a)] and then transitions to Stage 3 – Equalization Stage described at Section 5.8.2.3 below

5.8.2.3 Stage 3 –Adaptive Equalization Stage:

Refer Section 1.4.3.4 for general information on Equalization Stage and to Fig 5.2 for voltage and current curves during this stage

In this stage, charging takes place at constant voltage at value = the programmed value of parameter “EQUALIZE VOLTAGE” [Default value is 14.40V for EVO-2212/3012 and 28.80V for EVO-2224/4024. Please see programming range at Table 6.2 and programming procedure at Section 4.4.2.3 in EVO-RC Remote Control Manual attached at Appendix A]. It remains in this stage for computed time “T2” [Refer to Section 5.8.2.1.2(b)] and then transitions to Stage 4 described at Section 5.8.2.4 below

5.8.2.4 Stage 4 – Last Stage of 4-Stage Charging Profile for Equalization:

Stage 4 of the 4-Stage Charging Profile for Equalization will be the same as the last stage of the charging profile that was active when the 4-Stage Charging Profile for Equalization was switched on. See details at Table 5.2.1 below:

Table 5.2.1 Stage 4 of 4-Stage Adaptive Charging Profile for Equalization		
Charging Profile that was active when Equalization was started (1)	Last Stage of Charging Profile at Column (1) from where Equalization was started (2)	EVO-RC display at 1st line, right corner (See Note 1) (3)
0=3 Stage Adaptive	FLOAT: Charge at constant voltage = “FLOATING VOLTAGE” • Exit to BULK STAGE when: o Voltage drops to “RESET TO BULK”, or o After 10 days in Float Stage	0-FLOAT
1=3 Stage Type 1		1-FLOAT
2= 3 Stage Type 2		2-FLOAT
3= 2 Stage Type 1	OFF	3-OFF
4= 2 Stage Type 2	Absorption Stage	4-CV
5= 2 Stage Type 3	Off	5-OFF
NOTE 1:		
This portion of display is shown in the 1st line, right hand corner of GROUP 3: CHARGING MODE screens [Column 4 of Fig 3.2 in EVO-RC Remote Control Manual attached at Appendix A].		
<ul style="list-style-type: none"> • Numerals 0 to 5 indicate the specific Charging Profile (Column 1) that is active • FLOAT / CV indicates the charging stage (CV stands for “Constant Voltage Absorption Stage) • OFF indicates that charging is OFF 		

SECTION 5 | Battery Charging in Evolution™ Series

EXAMPLE BASED ON TABLE 5.2.1

Assume that 4-Stage Charging Profile for Equalization was switched on when 3-Stage Adaptive Charging Profile option "0= 3 Stage Type 0" was active [Column (1), Table 5.2.1]. In this Charging Profile, the last i.e. the 3rd Stage is FLOAT [Column (2), Table 5.2.1]. After completing the 3rd Stage of Equalization, the 4th Stage will, therefore, be FLOAT [Column (3), Table 5.2.1]. The right-hand corner display "0-FLOAT" [Column (3), Table 5.2.1] indicates:

- "0" for the parameter CHARGING PROFILE set at Option "0=3 Stage Type 0"
- "FLOAT" indicates the last FLOAT Stage of 3-Stage Adaptive CHARGING PROFILE Option "0=3 Stage Type 0"

5.8.3 Automatic Resetting of 4-Stage Adaptive Charging Profile

The 4-Stage Adaptive Charging Profile explained at Section 5.8.2 above will be reset to the First Stage i.e. the Bulk Stage [[Section 5.8.2.1](#)] as follows:

- a) If the AC input fails and is restored or, it is disconnected and is reconnected
- b) If battery discharges and its voltage falls to the voltage level set by programming parameter "RESET TO BULK" [[For details, refer to Section 4.4.2.15 of EVO-RC Remote Control Manual attached at Appendix A](#)]. Programming range for this parameter is:
 - i. 10 to 13VDC for EVO-2212 / EVO-3012 (Default value is 12.0VDC)
 - ii. 20 to 26VDC for EVO-2224 / EVO-4024 (Default value is 24.0VDC)
- c) If the charger remains in the Float Stage for 10 days

5.9 SWITCHING ON AND SWITCHING OFF PROCEDURE FOR 4-STAGE ADAPTIVE CHARGING PROFILE FOR EQUALIZATION

The default charging profile is "3-Stage Type 0" i.e. 3-Stage Adaptive [[Refer to \(i\) Srl. No 1, Table 5.2 and \(ii\) Section 4.4.2.21 in the EVO-RC Remote Control Manual at Appendix A](#)]. 4-Stage Adaptive Charging Profile for Equalization is required to be activated manually as follows:

- **Initiating 4-Stage Adaptive Charging Profile for Equalization using ON/OFF Push Button (11, Fig 2.1) on the Front Panel (only if the Remote Control EVO-RC is not connected to the EVO Inverter Charger or, is not available):** When the unit is in Charging Mode (qualified Grid / Generator Input is available), the Green LED marked "ON" (12, Fig 2.1) will be blinking once in 1 sec interval. Press the ON/OFF Button (11, Fig 2.1) for 1 second. The ongoing Charge Profile will be terminated and Adaptive Equalization will be initiated. The Green LED marked "ON" (12, Fig 2.1) will start blinking twice in 1 sec interval to show that the 4-Stage Adaptive Charging Profile for Equalization is active. The unit will complete Equalization and terminate in the last stage of the charging profile that was active at the time the Equalization Profile was activated (Section 5.8.2.4). Henceforth, charging will continue in the initial charging profile that was active before equalization was initiated. At the same time, the Charging Profile Setting will again be reset to the original and the Green LED marked "ON" (12, Fig 2.1) will return to 1 blink in 1 sec interval. **To terminate Equalization Profile prematurely before its completion, press the ON/OFF Push Button for 1 second.**

If the unit was in Inverting Mode [[Green LED marked "ON" \(12, Fig 2.1\) steady](#)] and the Charging Profile is set to 4-Stage Adaptive Charging Profile for Equalization as above by pressing the ON/OFF Push Button for 1 second, the unit will initiate Equalization Profile [whenever qualified AC input is available from Grid / Generator](#). To terminate Equalization Profile prematurely before its completion, press the ON/OFF Push Button for 1 second.

SECTION 5 | Battery Charging in Evolution™ Series

NOTE: Procedure described above is to be used when the optional Remote Control EVO-RC has NOT been plugged into the RJ-45 Remote Control Jack (7, Fig 2.1). **Please note if the Remote Control has been plugged into the RJ-45 Jack, the above procedure cannot be activated and the ON/OFF of Equalization Profile will be controlled by the Remote Control EVO-RC.**

5.10 2-STAGE CHARGING PROFILES

2-Stage Charging Profile may be used for charging Lead Acid, Lithium Ion and Nickel-Zinc (Ni-Zn) types of batteries.

In 2-Stage Charging Profile, the battery is charged in Bulk Stage first and then in Absorption Stage or Float Stage. There is no 3rd Stage.



INFO

The 2nd Stage i.e. Absorption Stage may also be referred to as Float Stage in some applications like charging Lead Acid Battery with load (battery backup application like in Telecom battery charging, Emergency Lighting etc.). In this application, the voltage setting of the 2nd Absorption Stage is lowered to the level corresponding to the Float Stage. Please note that under this condition, the battery will not charge fully but only to around 80%.

The following 3 programming options are available for 2-Stage Charging:

- 1) Option 3 = 2 Stage Type 1: Please refer to Srl. 1 of Table 5.3 for detailed description and Fig 5.3 for Voltage - Current (V-I) Curves
- 2) Option 4 = 2 Stage Type 2: Please refer to Srl. 2 of Table 5.3 for detailed description and Fig 5.4 for Voltage - Current (V-I) Curves
- 3) Option 5 = 2 Stage Type 3: Please refer to Srl. 3 of Table 5.3 for detailed description and Fig 5.5 for Voltage - Current (V-I) Curves



INFO

Please refer to Section 5.11 for more details regarding protections available in EVO Series when using 2-Stage Charging Profiles for charging Lithium Ion Battery Packs in association with their Battery Management System (BMS).

SECTION 5 | Battery Charging in Evolution™ Series

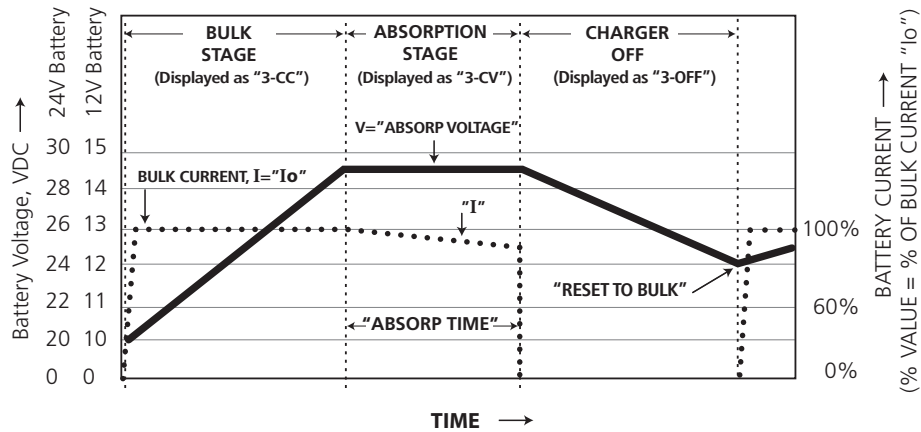

LEGEND for Fig 5.3

	Voltage (V) Curve
	Current (I) Curve
I_o	Bulk Stage Current. <i>Please see Section 5.7.1.1</i>
3-CC, 3-CV, 3-OFF	This coded information relates to the active Charging Profile and Charging Stage and is displayed in the right corner of the Charging Mode Display Screens of EVO-RC Remote Control. <i>Please see Table 3.2 under Section 3.6.3 of EVO-RC Remote Control Manual attached at Appendix A</i>

NOTES for Fig 5.3

- Please see Srl. 1 of Table 5.3 for details of charging process*
- Voltage (V) and Current (I) curves show the battery voltage and current.
- The Voltage (V) and Current (I) curves shown are based on the following operating conditions:
 - The battery is being charged exclusively by the Battery charging Section of EVO and that there is NO external charging source that is charging the battery / battery bank
 - There is no external DC load on the battery / battery bank (the entire current delivered by the Charging Section of EVO is being used to charge the battery / battery bank)

Fig 5.3 Voltage – Current (V-I) Curves for "2-Stage Type 1" Charging Profile

SECTION 5 | Battery Charging in Evolution™ Series

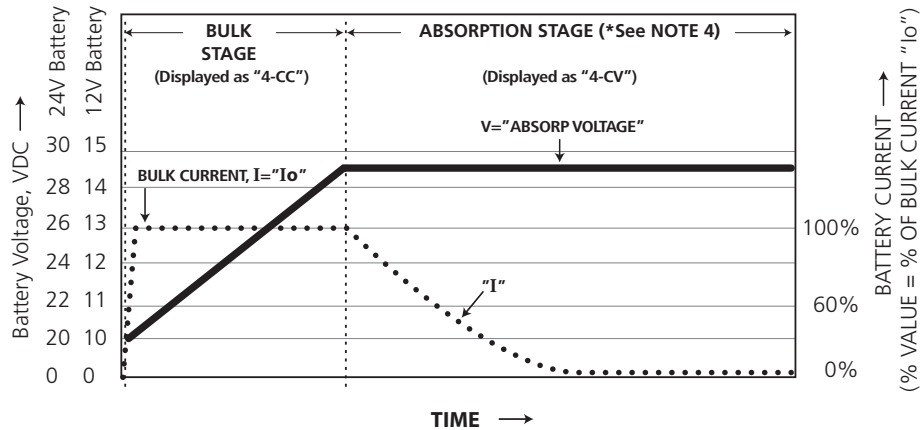

LEGEND for Fig 5.4	
—————	Voltage (V) Curve
•••••	Current (I) Curve
I_o	Bulk Stage Current. <i>Please see Section 5.7.1.1</i>
4-CC, 4-CV	This coded information relates to the active Charging Profile and Charging Stage and is displayed in the right corner of the Charging Mode Display Screens of EVO-RC Remote Control. <i>Please see Table 3.2 under Section 3.6.3 of EVO-RC Remote Control Manual attached at Appendix A</i>

NOTES for Fig 5.4	
1.	<i>Please see Srl. 1 of Table 5.3 for details of charging process</i>
2.	Voltage (V) and Current (I) curves show the battery voltage and current.
3.	The Voltage (V) and Current (I) curves shown are based on the following operating conditions: <ul style="list-style-type: none"> a) The battery is being charged exclusively by the Battery charging Section of EVO and that there is NO external charging source that is charging the battery / battery bank b) There is no external DC load on the battery / battery bank (the entire current delivered by the Charging Section of EVO is being used to charge the battery / battery bank)
4.	<i>Please see Section 5.7.4 regarding conditions under which the charger will be forced to reset automatically and restart charging from the 1st Stage i.e. Bulk Stage of the programmed CHARGING PROFILE</i>

Fig 5.4 Voltage – Current (V-I) Curves for "2-Stage Type 2" Charging Profile

SECTION 5 | Battery Charging in Evolution™ Series

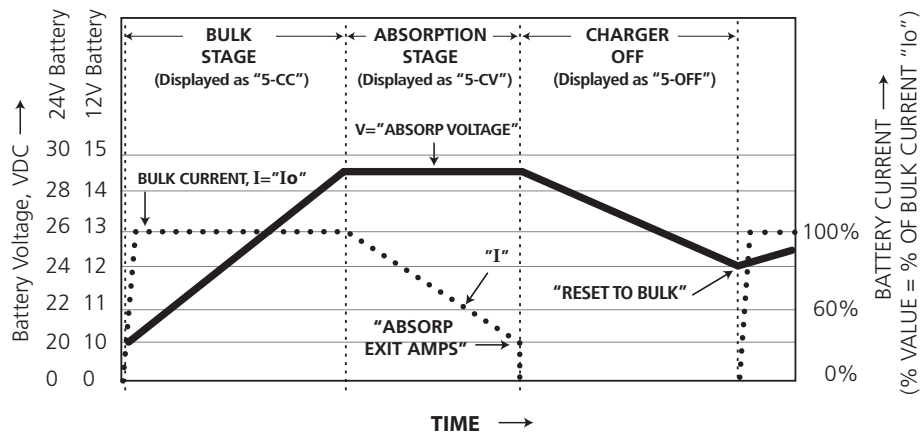

LEGEND for Fig 5.5	
	Voltage (V) Curve
	Current (I) Curve
I_o	Bulk Stage Current. <i>Please see Section 5.7.1.1.</i>
5-CC, 5-CV, 5-OFF	This coded information relates to the active Charging Profile and Charging Stage and is displayed in the right corner of the Charging Mode Display Screens of EVO-RC Remote Control. <i>Please see Table 3.2 under Section 3.6.3 of EVO-RC Remote Control Manual attached at Appendix A</i>
RESET TO BULK	At this point, the charger is forced to reset automatically from the operating charging stage and restart the selected CHARGING PROFILE from the 1 st Stage i.e. from the Bulk Stage. <i>Please see Section 5.7.4.</i>
ABSORP EXIT AMPS	When charging current in Absorption Stage drops to value set by programming parameter "ABSORP EXIT AMPS", the charger is switched off <i>[The default value of parameter "ABSORP EXIT AMPS" is 4A. For details of programming range or programming procedure, refer to Section 4.4.2.20 of the EVO-RC Remote Control Manual attached at Appendix-A]</i>

NOTES for Fig 5.5	
1.	<i>Please see Srl. 3 of Table 5.3 for details of charging process</i>
2.	Voltage (V) and Current (I) curves show the battery voltage and current.
3.	The Voltage (V) and Current (I) curves shown are based on the following operating conditions: <ul style="list-style-type: none"> a) The battery is being charged exclusively by the Battery charging Section of EVO and that there is NO external charging source that is charging the battery / battery bank b) There is no external DC load on the battery / battery bank (the entire current delivered by the Charging Section of EVO is being used to charge the battery / battery bank)

Fig 5.5 Voltage – Current (V-I) Curves for "2-Stage Type 3" Charging Profile

SECTION 5 | Battery Charging in Evolution™ Series

TABLE 5.3 3 TYPES OF CHARGING PROFILE OPTIONS FOR 2-STAGE CHARGING

Srl No.	Options under Programming Parameter "CHARGING PROFILE" <i>(See Section 4.4.2.21 in EVO-RC Remote Control Manual attached at Appendix A)</i>	Charging Stages	Battery Type
1	3=2Stage Type1 <u>REFER TO FIG 5.3 FOR VOLTAGE-CURRENT (V-I) CURVES.</u>	<p>1. Stage 1 – Bulk Stage (See Section 5.7.1.1)</p> <ul style="list-style-type: none"> Charge at constant current = the programmed value of parameter "BULK CURRENT" (Default value is 40A. <i>For details of programming range & procedure, refer to Section 4.4.2.1 of EVO-RC Remote Control Manual attached at Appendix-A</i>) Transition to Absorption Stage when voltage rises to the set value for programming parameter "ABSORP VOLTAGE" (Default value is 14.4V for EVO-2212/3012 and 28.8V for EVO-2224/4024. <i>For details of programming range & procedure, refer to Section 4.4.2.2 of EVO-RC Remote Control Manual attached at Appendix-A</i>) <p>2. Stage 2 - Absorption Stage (See Section 5.7.2)</p> <ul style="list-style-type: none"> Charge at constant voltage = the programmed value for parameter "ABSORP VOLTAGE". (Default value is 14.4V for EVO-2212/3012 and 28.8V for EVO-2224/4024. <i>For details of programming range & procedure, refer to Section 4.4.2.2 of EVO-RC Remote Control Manual attached at Appendix-A</i>) Remain in Absorption Stage till the time in Absorption Stage is = the programmed value of parameter "ABSORP TIME" (Default value is 60 min. <i>For details of programming range & procedure, refer to Section 4.4.2.19 of EVO-RC Remote Control Manual attached at Appendix-A</i>) Switch off charging after expiry of programmed value of parameter "ABSORP TIME" (Default value is 60 min. <i>For details of programming range & procedure, refer to Section 4.4.2.19 of EVO-RC Remote Control Manual attached at Appendix-A</i>) Reset to Bulk Stage under the following conditions: <ol style="list-style-type: none"> If the AC input from the Grid/Generator is disconnected and is reconnected. If battery voltage falls to the programmed value of parameter "RESET TO BULK" (Default value is 12.0V for EVO-2212/3012 & 24.0V for EVO-2224/4024. <i>For details of programming range & procedure, refer to Section 4.4.2.15 of EVO-RC Remote Control Manual attached at Appendix-A</i>) 	<ul style="list-style-type: none"> Lithium (<i>See Section 5.11</i>) Nickel Zinc (<i>See Section 5.10</i>)

SECTION 5 | Battery Charging in Evolution™ Series

<p>2</p> <p>4=2Stage Type2</p> <p><u>REFER TO FIG 5.4 FOR VOLTAGE-CURRENT (V-I) CURVES</u></p>	<p>1. Stage 1 – Bulk Stage (See Section 5.7.1.1)</p> <ul style="list-style-type: none"> Charge at constant current = the programmed value of parameter “BULK CURRENT” (Default value is 40A. <i>For details of programming range & procedure, refer to Section 4.4.2.1 of EVO-RC Remote Control Manual attached at Appendix-A)</i> Transition to Absorption Stage when voltage rises to the set value for programming parameter “ABSORP VOLTAGE” (Default value is 14.4V for EVO-2212/3012 and 28.8V for EVO-2224/4024. <i>For details of programming range & procedure, refer to Section 4.4.2.2 of EVO-RC Remote Control Manual attached at Appendix-A)</i> <p>2. Stage 2 - Absorption Stage (See Section 5.7.2)</p> <ul style="list-style-type: none"> Charge at constant voltage (CV) = the programmed value for parameter “ABSORP VOLTAGE”. (Default value is 14.4V for EVO-2212/3012 and 28.8V for EVO-2224/4024. <i>For details of programming range & procedure, refer to Section 4.4.2.2 of EVO-RC Remote Control Manual attached at Appendix-A)</i> Remain in Absorption Stage Reset to Bulk Stage under the following conditions: <ul style="list-style-type: none"> i. If the AC input from the Grid/Generator is disconnected and is reconnected. ii. If battery voltage falls to the programmed value of parameter “RESET TO BULK” (Default value is 12.0V for EVO-2212/3012 & 24.0V for EVO-2224/4024. <i>For details of programming range & procedure, refer to Section 4.4.2.15 of EVO-RC Remote Control Manual attached at Appendix-A)</i> 	<p>– Lithium (<i>See Section 5.11</i>)</p>
<p>3</p> <p>5=2Stage Type3</p> <p><u>REFER TO FIG 5.5 FOR VOLTAGE-CURRENT (V-I) CURVES</u></p>	<p>1. Stage 1 – Bulk Stage (See Section 5.7.1.1)</p> <ul style="list-style-type: none"> Charge at constant current = the programmed value of parameter “BULK CURRENT” (Default value is 40A. <i>For details of programming range & procedure, refer to Section 4.4.2.1 of EVO-RC Remote Control Manual attached at Appendix-A)</i> Transition to Absorption Stage when voltage rises to the set value for programming parameter “ABSORP VOLTAGE” (Default value is 14.4V for EVO-2212/3012 and 28.8V for EVO-2224/4024. <i>For details of programming range & procedure, refer to Section 4.4.2.2 of EVO-RC Remote Control Manual attached at Appendix-A)</i> <p>2. Stage 2 - Absorption Stage (See Section 5.7.2)</p> <ul style="list-style-type: none"> Charge at constant voltage = the programmed value for parameter “ABSORP VOLTAGE”. (Default value is 14.4V for EVO-2212/3012 and 28.8V for EVO-2224/4024. <i>For details of programming range & procedure, refer to Section 4.4.2.2 of EVO-RC Remote Control Manual attached at Appendix-A)</i> Remain in Absorption Stage till the current reduces to value = the programmed value of parameter “ABSORP EXIT AMPS” (Default value is 4A. <i>For details of programming range & procedure, refer to Section 4.4.2.20 of EVO-RC Remote Control Manual attached at Appendix-A)</i> Switch off charging after the current reduces to value = the programmed value of parameter “ABSORP EXIT AMPS” (Default value is 4A. <i>For details of programming range & procedure, refer to Section 4.4.2.20 of EVO-RC Remote Control Manual attached at Appendix-A)</i> Reset to Bulk Stage under the following conditions: <ul style="list-style-type: none"> i. If the AC input from the Grid/Generator is disconnected and is reconnected. ii. If battery voltage falls to the programmed value of parameter “RESET TO BULK” (Default value is 12.0V for EVO-2212/3012 & 24.0V for EVO-2224/4024. <i>For details of programming range & procedure, refer to Section 4.4.2.15 of EVO-RC Remote Control Manual attached at Appendix-A)</i> 	<p>– Lithium (<i>See Section 5.11</i>)</p> <p>– Nickel Zinc (<i>See Section 5.10</i>)</p>

SECTION 5 | Battery Charging in Evolution™ Series

5.11 CHARGING LITHIUM ION BATTERIES



CAUTION!

The Battery Management System (BMS) that comes with the Lithium Ion Battery being used may need to have control over charging and discharging of the battery. For this, any of Pins 1/2/3/4 and any of Pins 5/6/7/8 of the Temperature Sensor Jack (6, Fig 2.1; Pinout at Fig 3.13) may be used to feed potential free contact closing signal from the BMS to "Stop Charging" or "Stop Inverting". See Section 5.11.2 below for details.



ATTENTION!

Le système de gestion de la batterie (BMS) qui vient avec la batterie au lithium-ion utilisé peut avoir besoin d'avoir le contrôle de charge et décharge de la batterie. Pour cela, n'importe lequel des broches 1/2/3/4 et 5/6/7/8 de la prise de capteur de température (6, Fig. 2.1; Pinout à la Fig. 3.13) peut être utilisé pour l'alimentation contact libre de signal de fermeture de la BMS à "arrêter la charge" ou "arrêter d'inverser". Se reporter à la Section 5.11.2 pour plus de détails.

5.11.1 Charging Profiles for Lithium Batteries

Programming parameter "CHARGING PROFILE" is used to select up to 5 programming options for 2/3-Stage charging profiles for Lithium Ion Batteries. Details are given in Table below:

Srl. No. Table 5.2	Srl. No. of Table 5.3	Option under Parameter "CHARGING" Profile (Section 4.4.4.2.21 of EVO-RC Remote Control Manual attached at Appendix A)
2	—	"1 = 3-Stage Type 1"
3	—	"2 = 3-Stage Type 2"
—	1	"3 = 2-Stage Type 1"
—	2	"4 = 2-Stage Type 2"
—	3	"5 = 2-Stage Type 3"



INFO

Charging of Lithium Ion Batteries is not affected by temperature and hence, Battery Temperature Sensor Model EVO-BCTS [Fig 2.5(a)] is not required to be used

5.11.2 Stop Charging and Stop Inverting Protections when Charging Lithium Batteries

For background information, refer to Section 4.4.2.22.2 in the EVO-RC Remote Control Manual attached at Appendix-A. For protection against over-voltage / over-temperature / over-discharge, Lithium Ion Battery Management Systems

SECTION 5 | Battery Charging in Evolution™ Series

(BMS) will normally have capability of providing potential free relay contact closure signal that could be fed to Inverter Charger to stop charging or stop inverting. For this, the BMS will normally use miniature, Normally Open (1-Form-A), Open Drain Opto-Isolated DC Solid-State Relay (SSR). The Solid-State Relay output terminals in the BMS are normally marked "+" (Drain of Mosfet Switch) and "-" (Source of Mosfet Switch). Example of this type of relay is IXYS Part No. "CPC1002N" (60V, 700mA rating).

The following 2 types of signals are normally used by the BMS for on/off control of charging and inverting operation of the Inverter-Charger:

- **"Stop Charging" Signal:** In case of (i) over voltage of individual cell / overall battery pack, or (ii) over temperature of individual cell or overall battery pack, the signal will be "enabled" and SSR contacts will close [Drain (+) and Source (-) Terminals will be shorted].
- **"Stop Inverting" Signal:** In case of deep discharge of the battery to the level of Low Battery Cut Off Voltage, the signal will be "enabled" and the SSR contacts will close [Drain (+) and Source (-) Terminals will be shorted].

If the above two protection functions of the BMS i.e. *"Stop Charging"* and *"Stop Inverting"* are to be used for on / off control of charging and inverting operations of EVO Inverter-Charger, the following actions will be required to be undertaken:

- a) Programming parameter **"BATTERY TYPE"** must be changed from Option 1 - "0=Lead Acid" (Default setting) to Option 2 - "1=Lithium" [See Section 4.4.2.22 of EVO-RC Remote Control Manual attached at Appendix A]. With this setting, the function of front panel RJ-45 Jack marked "Battery Temp. Sensor: (6, Fig 2.1) will change from accepting and processing battery temperature signal from the Battery Temperature Sensor EVO-BCTS to accepting and processing potential free relay contact closure signal from the Solid-State Relay from the BMS to stop charging /inverting.
- b) **Wiring Connection:** Output from the SSR Terminals on the Lithium Battery BMS should be wired to the RJ-45 Jack marked "Battery Temp. Sensor" (6, Fig 2.1) as follows:
 - Connect terminal marked "+" on the SSR (Drain of Mosfet switch inside SSR) to any of pins 1/2/3/4 of RJ-45 Jack (Pinout shown below)
 - Connect terminal marked "-" on the SSR (Source of Mosfet switch inside SSR) to any of pins 5/6/7/8 of RJ-45 Jack (Pinout shown below)

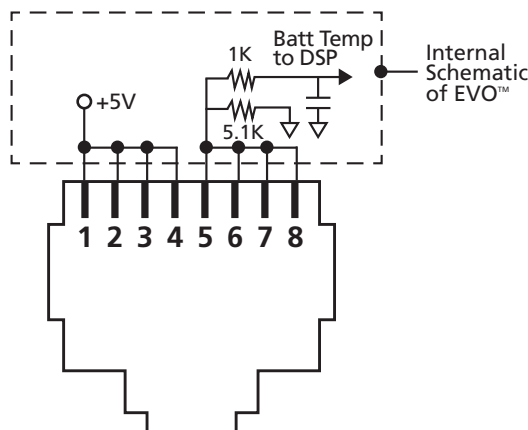

Pinout of RJ-45 Jack (marked "Battery Temp. Sensor") on the Front Panel of EVO (6, Fig 2.1)

SECTION 5 | Battery Charging in Evolution™ Series

When the Drain-Source terminals of the BMS close, Pins 1/2/3/4 and 5/6/7/8 of RJ-45 Jack will be shorted. The following actions will be activated in EVO:

- **EVO in Charging Mode:** Charging will stop (Internally, the EVO will be in Charging Mode, but the charging current will be reduced to 0A). The 1st Line of the Overall Operating Mode Display Screens shown under Column 4 for “GROUP 3: CHARGING MODE” display Screens [\[Fig 3.2 in EVO-RC Manual attached at Appendix A\]](#) will show “CHR STOP BY BMS” as shown in example below:

Example of Screen No. 1 of 19 Screens under Column 4 for GROUP 3: CHARGING MODE” [\[Fig 3.2 in EVO-RC Remote Control Manual attached at Appendix A\]](#)

CHGR	STOP	BY	BMS
OUTPUT	120	.00	V

- **EVO in Inverting Mode:** Inverting will stop (Internally, the EVO will enter Standby Mode). The 1st Line of the Operating Mode Screens shown in the Menu Map for GROUP 1: STANDBY MODE” display Screens [\[Fig 3.2 in EVO-RC Manual attached at Appendix A\]](#) will show “INV STOP BY BMS” as shown in example below:

Example of Screen No. 1 of 7 Screens under Column 1 for GROUP 1: STANDBY MODE” [\[Fig 3.2 in EVO-RC Remote Control Manual attached at Appendix A\]](#)

INV	STOP	BY	BMS
BATTERY	12	.000	V

5.12 OPERATING MODE OPTION - “CHARGER ONLY”

In Off-grid DC powered homes, for efficiency consideration, all lighting and other loads / appliances are normally powered from 12V batteries that are primarily charged through solar / wind power. Generator backup is used for powering AC to DC battery charger for charging the batteries during extended periods of cloudy / no wind conditions. To meet this requirement, the EVO™ can be programmed to operate as a battery charger ONLY i.e. when AC input power is available within the programmed limits of voltage and frequency, charging will take place and AC input will be passed through to the load(s). The unit will not transfer to Inverting Mode if AC input fails or is outside the programmed limits of voltage and frequency. [For further details refer to Section 4.4.2.13.3 in EVO-RC Remote Control Manual attached at Appendix A.](#)

SECTION 6 | Operation, Protections and Troubleshooting



CAUTIONS!

- a) Please ensure that all safety instructions at Section 1 of this manual are read and understood before operating the unit
- b) Please ensure that the unit has been installed properly as per instructions at Section 3 of this manual



ATTENTIONS!

- a) *Veillez vous assurer que toutes les instructions de sécurité de la Section 1 de ce manuel sont lues et comprises avant d'utiliser l'appareil.*
- b) *Veillez vous assurer que l'appareil a été installé correctement conformément aux instructions de la section 3 de ce manuel.*



INFO

Please ensure that charged battery has been connected to the DC Input Terminals (1 and 2 in Fig2.1). This unit will NOT operate if specified battery voltage as shown below is not available at the DC Input terminals:

- a) 12V units i.e. EVO-2212/3012..... $\geq 9.1\text{VDC}$
- b) 24V units i.e. EVO-2224/4024..... $\geq 18.1\text{VDC}$

6.1 POWERING ON / POWERING OFF USING FRONT PANEL ON/OFF BUTTON (11, FIG 2.1)



INFO

For power on / power off sequence using EVO-RC Remote Control, refer to Section 3.2 of EVO-RC Remote Control Manual attached at Appendix A.

6.1.1 Manual Power on Sequence when AC Input is in Switched Off condition / Not Connected:

To power ON the unit, press and hold the ON/OFF Button on the front panel (11, Fig 2.1) for around 3 seconds until completion of sequence shown below:

- Green LED marked "ON" (12, Fig 2.1) will blink 3 times, will go off momentarily and will then be steady Green. Now, release the ON/OFF Button. Subsequently, the lighting pattern of this LED will be controlled by various operating conditions given in Table 6.1

NOTE: *For Power on / off sequence when using the optional Remote Control EVO-RC, please refer to Section 3.2 of EVO-RC Remote Control Manual at Appendix A.*

SECTION 6 | Operation, Protections and Troubleshooting

6.1.2 Automatic Power on Sequence when AC Input Power is in Switched on Condition:

Automatic "Power on Sequence" will be initiated if:

- i. AC input power $> 70 \pm 5\text{VAC}$ is made available at the Grid / Generator Input Terminals and,
- ii. The battery voltage is $> 12\text{V}$ for EVO-2212 / 3012 and $> 24\text{V}$ for EVO-2224 / 4024. If no fault condition(s) is detected, the unit enters "Charging Mode" if AC input power is within the programmed limits of voltage and frequency or Inverting Mode if AC input power is NOT within the programmed limits of voltage and frequency.

NOTE: *For power on / power off Sequence when using the optional Remote Control EVO-RC, please refer to Section 3.2 of EVO-RC Remote Control Manual attached at Appendix A.*

6.1.3 Power off Sequence:

6.1.3.1 Power off Sequence when AC Input is in Switched off Condition / Not Connected:

When the AC input is in switched off condition / not connected and the unit is in ON condition, the unit will be operating in Inverting Mode and the Green LED marked "ON (12, Fig 2.1) will be in steady ON condition.

To power OFF the unit, press and hold the ON/OFF Button (11, Fig 2.1) for around 5 seconds. Wait for the Green LED marked "ON" (12, Fig 2.1) and Red LED marked "FAULT / ALARM" (13, Fig 2.1) to light steady and then release the ON/OFF Button. The unit will power OFF after the ON/OFF Button is released. ***[NOTE: "Power off Sequence" will complete ONLY when the Power ON/OFF Button is released!]***

NOTE: *For Power on / off Sequence when using the optional Remote Control EVO-RC, please refer to Section 3.2 of EVO-RC Remote Control Manual at Appendix A)*

6.1.3.2 Power off Sequence when AC Input Power is in Switched on Condition (AC Input Voltage $> 70 \pm 5\text{VAC}$)

Please note that as long as AC input voltage $> 70 \pm 5\text{VAC}$ is available at the Grid / Generator Input Terminals, the unit ***CANNOT BE POWERED OFF*** using the On/Off Button on the front panel of the unit or the On/Off Key on the optional Remote Control EVO-RC *[See Section 3.2.2 of EVO-RC Remote Control Manual at Appendix A]*. ***Switch off the AC input power first if the unit is required to be powered off.*** However, if the unit is in "Fault Mode", it will be possible to power off the unit with the help of On/Off Button on the front panel of the unit or the On/Off Key on the optional Remote Control EVO-RC

NOTE: *For Power on / off Sequence when using the optional Remote Control EVO-RC, please refer to Section 3.2 of EVO-RC Remote Control Manual at Appendix A.*

6.2 POWERING ON / OFF BY FEEDING EXTERNAL +12V SIGNAL TO TERMINALS MARKED "REMOTE ON/OFF" ON THE FRONT PANEL

The unit can be switched ON /OFF remotely by feeding specified format of +12VDC (+9 to 15VDC, $< 10\text{mA}$) signal to terminals marked "Remote On / Off" on the Front Panel (15, Fig 2.1). The specified +12V signal format has 2 options – "Button Type" or "Switch Type". These 2 signal format options can be programmed using the optional Remote

SECTION 6 | Operation, Protections and Troubleshooting

Control EVO-RC. These options are available under programmable parameter called "REMOTE SWITCH" grouped under Parameter Menu Map for Parameter Group 5: OTHER FUNCTION". *Please refer to the following Sections of the EVO-RC Remote Control Manual attached at Appendix A:*

- Section 4.1, Fig 4.2: Screen No. 4 under column "SELECT GROUP – OTHER FUNCTION"
- Section 4.8.1, Table 4.7: Srl No. 4 "REMOTE SWITCH"
– 0=Button Type (Default); 1=Switch Type
- Section 4.8.2.4: Detailed explanation of programmable parameter REMOTE SWITCH

6.2.1 Button Type On/Off Control Using +12V Signal (Default)

This type of external +12V signal format is used when the signal is fed through an external series connected Push Button [+12V will be fed as long as the Push Button is kept pressed]. Control logic used is as follows:

- When the EVO™ is in OFF condition, momentary feeding of +12V signal through the external Push Button for > 2 sec will turn the unit ON. The EVO™ will remain ON even when the Push Button is released
- When the EVO™ is in ON condition, momentary feeding of +12V signal through the external Push Button for > 5 sec will turn the EVO™ OFF.

NOTE: *If the external Push Button is pressed for < 5 sec, the unit will NOT switch OFF*

6.2.2 Switch Type On/Off Control Using +12V Signal

This type of external +12V signal format is used when the +12V signal (+9 to 15 VDC, < 10mA) is fed through an external, series connected On/Off Toggle / Rocker Switch or Relay contact (+12V signal will be fed continuously when the switch in ON condition / Relay contact is closed and +12V signal will be removed when the external On/Off switch is in OFF condition or the Relay contact is open). Example of this type of Remote On/Off Control signal format is the Ignition Switch in a vehicle. When the Ignition Switch is ON, 12V from the vehicle battery will be available. When the Ignition Switch is OFF, 12V will be switched OFF. Control logic used is as follows;

- When the external On/Off Switch is turned ON or when the Relay contact is closed, continuous +12V control signal will be made available and the EVO™ will turn ON. EVO™ will remain ON as long +12V control signal is available through the ON condition of the external On/Off Switch or the closed Relay contact
- When the external On/Off Switch is turned OFF or if the Relay contact opens, the +12V signal will be removed and the EVO™ will switch OFF



CAUTION!

When "Switch Type" of ON/OFF control described at Section 6.2.2 above is selected, the ON/OFF Button on the front panel of the unit (12, Fig 2.1) should NOT be used to turn ON or turn OFF the unit. The front panel ON/OFF Push Button will now follow the above "Switch Type" control logic wherein the unit will remain ON only as long as the Button is kept pressed and will turn OFF in 2 seconds after it is released.

SECTION 6 | Operation, Protections and Troubleshooting



ATTENTION!

Lorsque « Switch Type » de ON/OFF contrôle décrit ci-dessus est sélectionnée, le bouton on/off sur le panneau avant de l'unité (12, Fig 2.1) ne devraient pas servir à allumer ou éteindre l'appareil. La façade, bouton poussoir On/Off suivra désormais la logique de contrôle ci-dessus « Switch Type » dans lequel l'appareil demeurera allumé aussi longtemps que la touche est maintenue enfoncée et s'éteint après 2 secondes après que qu'il est libéré.

6.3 OPERATIONAL INFORMATION THROUGH LEDS AND BUZZER

Table 6.1 shows the operational states of the unit indicated by the following LEDs on the front panel of the unit and Buzzer:

- Green LED marked "ON" (12, Fig 2.1)
- Red LED marked "Fault" (13, Fig 2.1)

Optional Remote Control Model EVO-RC will be required for more detailed messaging that is available through its LCD display and LEDs. *This remote will also be required for programming of various parameters to suit specific requirements.*

TABLE 6.1 FRONT PANEL LED AND BUZZER INDICATIONS

Status	Green LED marked "ON" (12, Fig 2.1)	Red LED marked "Fault" (13, Fig 2.1)	Buzzer (See NOTE 1 Below)
Seen during Power-On Sequence (Refer to Section 6.1.1)	Blink 3 times & then off	Off	Off
Seen during Power-Off Sequence (Refer to Section 6.1.2)	On	On	Off
Normal charging	Blink once in 1 sec interval	Off	Off
Equalization charging	Blink twice in 1 sec interval	Off	Off
Inverting (Discharging)	On	Off	Beep once in 3 sec interval
Low battery alarm	On	Blink once in 1 sec interval	Beep once in 1 sec interval
Power saving	Blink once in 3 sec interval	Off	Off
Standby	Blink once in 5 sec interval	Off	Off
Fault	Off	On	On

NOTE 1:

The buzzer can be switched on or off through programming parameter "BUZZER" [Refer to Section 4.8.2.7 of EVO-RC Manual attached at Appendix A. The default setting is "1 = On"].

SECTION 6 | Operation, Protections and Troubleshooting

6.4 OPTIONAL REMOTE CONTROL EVO-RC (see attached Appendix A) FOR PROGRAMMING OF MODES OF OPERATION AND PARAMETERS

Optional Remote Control Model EVO-RC [Fig 2.4(a)] will be required for more advanced control and monitoring. Please see separate Owner's Manual for EVO-RC (attached at Appendix A). The Remote Control comes with 10M / 33 ft., RJ-45 Data Cable. The Remote plugs into RJ-45 Jack on the front panel of the unit (7, Fig 2.1). It has provision for Data Logging using SD Card of up to 16 GB (FAT16 / FAT32). It also has its own Real Time Clock and Super Capacitor Type of Battery.

Detailed messaging is available through its LCD display and LEDs. This remote will also be required for programming of various parameters to suit specific requirements. Each programmable parameter has a Default Value. This unit has been shipped with the various parameters set at the Default Values.

6.4.1 Programmable & Default Values of Programming Parameters

Programmable and Default values are shown in Tables 6.2 to 6.6:

TABLE 6.2 PROGRAMMABLE AND DEFAULT PARAMETERS: PARAMETER GROUP NO.1 "CHARGING CURVE"								
Parameter	Programming Range (Programming requires optional Remote Control Model EVO-RC)				Default			
	EVO-2212	EVO-3012	EVO-2224	EVO-4024	EVO-2212	EVO-3012	EVO-2224	EVO-4024
"BULK CURRENT" (See NOTE 1) (Bulk Charge Current "I _o ")	0-100A	0-130A	0-70A	0-110A	40A			
"ABSORP VOLTAGE" (Absorption Voltage)	12.00V - 16.00V		24.00V - 32.00V		14.40V		28.80V	
"EQUALIZE VOLTAGE" (Equalization Voltage)	14.00V - 16.50V		28.00V - 33.00V		14.40V		28.80V	
"FLOATING VOLTAGE" (Float Voltage)	12.00V - 15.00V		24.00V - 30.00V		13.50V		27.00V	
"COMPENSATE" (Temperature Compensation)	3mV to 5mV /C/Cell				4mV /C/Cell			
"BATT OVER VOLT" (Battery Over Voltage Shutdown)	14.00V - 17.00V		28.00V - 35.00V		16.00V		32.00V	
"RESET VOLTAGE" (Reset voltage for "BATT LOW VOLTAGE" condition)	12.00V - 17.00V		28.00V - 35.00V		14.00V		28.00V	
"LOW VOLT ALARM" (Battery Low Voltage Alarm)	9.50V to 13.50V		19.00V to 27.00V		11.00V		22.00V	
"BATT LOW VOLTAGE" (Battery Low Voltage Shutdown)	>9.00V to 13.00V		>18.00V to 26.00V		10.50V		21.00V	

SECTION 6 | Operation, Protections and Troubleshooting

"LV DETECT TIME" (Time to qualify "BATT LOW VOLTAGE" condition)	0 - 600 sec		10 sec	
"LV CUT OFF TIME" (Time in "BATT LOW VOLTAGE" condition to trigger complete shutdown)	0 - 7200 sec		1200 sec	
"EQUALIZE-4STAGES" (4 Stage Adaptive Equalization On/ Off)	0 = No (3-Stage / 2-Stage) 1 = Yes (4-Stage Equalization)		0 = No (3-Stage / 2-Stage)	
"MODE"	0 = Normal...Grid/Gen priority (Off-Line) 1 = On-Line...Inverter priority 2 = Charger Only...Charging & AC bypass only, no inverting		0 = Normal	
"ONLINE OPTION"	0 = Option 1 1 = Option 2		0 = Option 1	
"RESET TO BULK"	10.00V to 13.00V	20.00V to 26.00V	12.00V	24.00V
"GS DETECT TIME"	0 - 600 sec		10 sec	
"GEN ON TIME"	0 - 240 min		60 min	
"GEN OFF DELAY"	0 - 240 min		60 min	
"ABSORP TIME"	0 - 600 min		60 min	
"ABSORP EXIT AMPS"	0 - 20A		4A	
"CHARGING PROFILE"	0 = 3 Stage Adaptive 1 = 3 Stage Type 1 2 = 3 Stage Type 2 3 = 2 Stage Type 1 4 = 2 Stage Type 2 5 = 2 Stage Type 3		0 = 3 Stage Adaptive	
"BATTERY TYPE"	0 = Lead Acid 1 = Lithium		0 = Lead Acid	
"SAFE CHARGING"	0 - 300 min		0 min	
NOTE 1: "BULK CURRENT" value may automatically reduce in higher ambient temperatures of around 50° - 60°C if Power Transformer temperature exceeds 130°C or Heat Sink temperature exceeds 65°C. <i>(See Section 4.11.3)</i>				

SECTION 6 | Operation, Protections and Troubleshooting

Group	Parameter name	Programming Range				Default value			
		EVO-2212	EVO-3012	EVO-2224	EVO-4024	EVO-2212	EVO-3012	EVO-2224	EVO-4024
INPUT SETTING	DEFAULT FREQ	0 = 60Hz 1 = 50Hz				0 = 60Hz			
	GRID MAX CURRENT	5.00A to 40.00A	5.00A to 70.00A	5.00A to 40.00A	5.00A to 70.00A	30.00A			
	GEN MAX CURRENT	5.00A to 40.00A	5.00A to 70.00A	5.00A to 40.00A	5.00A to 70.00A	30.00A			
	HIGH CUT OFF	50 – 70Hz				65Hz			
	HIGH RESET	50 – 70Hz				64Hz			
	LOW CUT OFF	40 – 60Hz				55Hz			
	LOW RESET	40 – 60Hz				56Hz			
	SYNC GRID	0 = Fine ; 1 = Coarse				0 = Fine			
	SYNC GEN	0 = Fine ; 1 = Coarse				1 = Coarse			
	INPUT OC PROTECT	0 = INV Mode ; 1 = Shutdown				0 = INV Mode			
INPUT RECOVERY	0 = Buffered ; 1 = Direct				0 = Buffered				

Group	Parameter name	Setting range				Default value			
		EVO-2212	EVO-3012	EVO-2224	EVO-4024	EVO-2212	EVO-3012	EVO-2224	EVO-4024
INPUT - LOW LIMIT	RESET VOLTAGE	60.0 – 120.0V				105.0V			
	CUT OFF VOLT 1	60.0 – 120.0V				100.0V			
	DETECT TIME 1	0 – 2000 cycle				300 cycle			
	CUT OFF VOLT 2	60.0 – 120.0V				95.0V			
	DETECT TIME 2	0 – 2000 cycle				60 cycle			
	CUT OFF VOLT 3	60.0 – 120.0V				90.0V			
	DETECT TIME 3	0 – 2000 cycle				1 cycle			

SECTION 6 | Operation, Protections and Troubleshooting

Group	Parameter name	Setting range				Default value			
		EVO-2212	EVO-3012	EVO-2224	EVO-4024	EVO-2212	EVO-3012	EVO-2224	EVO-4024
INPUT - HIGH LIMIT	RESET VOLTAGE	120.0 – 150.0V				125.0V			
	CUT OFF VOLT 1	120.0 – 150.0V				135.0V			
	DETECT TIME 1	0 – 2000 cycle				60 cycle			
	CUT OFF VOLT 2	120.0 – 150.0V				140.0V			
	DETECT TIME 2	0 – 2000 cycle				15 cycle			
	CUT OFF VOLT 3	120.0 – 150.0V				145.0V			
	DETECT TIME 3	0 – 2000 cycle				1 cycle			

Parameter name	Setting range				Default Value			
	EVO-2212	EVO-3012	EVO-2224	EVO-4024	EVO-2212	EVO-3012	EVO-2224	EVO-4024
"POWER SAVING"	1 = Enable 0 = Disable				0 = Disable			
• "ENTER POINT"	4 – 50W				6W	8W	6W	8W
• "WAKE UP POINT"	5 – 50W				7W	10W	7W	10W
<p>"REMOTE SWITCH"</p> <ul style="list-style-type: none"> For ON /OFF control through external 12V signal fed to Remote ON / OFF terminals on the Front Panel (15, Fig 2.1) 	<p>0 = Button Type: 12V signal is fed through Push Button Type of Switch</p> <ul style="list-style-type: none"> Pressing of Push Button > 2 sec will switch the unit ON When ON, pressing Push Button > 5 sec will turn the unit OFF <p>1 = Switch Type: 12V signal is fed through contacts of Toggle Type of Switch or relay contact</p> <ul style="list-style-type: none"> ON condition (contacts closed) will turn the unit ON OFF condition (contacts open) for 2 sec will switch the unit OFF 				<p>0 = Button Type</p> <p>CAUTION! ON/OFF Logic also controls the operation of the ON/OFF Button on the front panel (11, Fig 2.1). The Default setting is "Button Type". If the ON/OFF Control is changed to external "Remote Switch", it will not be possible to switch ON/OFF the EVO Inverter/Charger from the front panel ON/OFF Push Button because it will work with Switch Type Logic. It will be ON only as long as the Push Button is kept pressed and will switch OFF when released.</p>			
Table continues on next page ▶								

SECTION 6 | Operation, Protections and Troubleshooting

TABLE 6.6 PROGRAMMABLE AND DEFAULT PARAMETERS: PARAMETER GROUP NO.5 "OTHER FUNCTIONS" (Continued)

Parameter name	Setting range				Default Value			
	EVO-2212	EVO-3012	EVO-2224	EVO-4024	EVO-2212	EVO-3012	EVO-2224	EVO-4024
"RELAY FUNCTION" (for Status Relay)	0 = Charge / Other <ul style="list-style-type: none"> • OFF in "Charging" Mode • ON in other Modes i.e. "Inverting", "Power Saving" or "Standby" 1 = Normal / Fault <ul style="list-style-type: none"> • OFF in normal operating conditions • ON in Fault Modes 2 = Generator 0 <ul style="list-style-type: none"> • ON when batteries drop to "LOW VOLT ALARM" or lower for period = "GS DETECT TIME" - Initiates Generator start • OFF after batteries are charged till the end point of the programmed option under parameter "CHARGING PROFILE" <i>[See Section 4.8.2.5.2.1 of EVO-RC Remote Control Manual attached at Appendix-A].</i> When the relay switches OFF, it initiates Generator Stop. 3 = Generator 1 <ul style="list-style-type: none"> • ON when batteries drop to "LOW VOLT ALARM" or lower for period = "GS DETECT TIME" - initiates Generator start • OFF when batteries are charged to "RESET VOLTAGE" for period = "GEN OFF TIME" - initiates Generator stop 4 = Generator 2 <ul style="list-style-type: none"> • ON when batteries drop to "LOW VOLT ALARM" or lower for period = "GS DETECT TIME" - initiates Generator start • OFF after period = "GEN ON TIME" from the time relay switched ON - initiates Generator stop 				2 = Generator 0			
"COMM ID" (Communication ID for optional Remote Control EVO-RC)	1 - 255				1			
"BUZZER"	0 = OFF ; 1 = ON				1 = On			
"DISCHARGE BEEP" (Beeping in "Discharging / Inverter Mode")	0 = OFF ; 1 = ON				0 = Off			
"DEFAULT RESET"	0 = No ; 1 = YES				0 = No			
DATA LOG TIME (For Optional Remote Control EVO-RC)	0 = Disable 3 = 30 sec 6 = 10 min 1 = 1 sec 4 = 1 min 2 = 10 sec 5 = 5 min				1 = 1 sec			
PARAMETER SAVE (For Optional Remote Control EVO-RC)	0 = No 1 = Yes				0 = No			
TEMP UNIT	0 = C 1 = F				0 = C			
PASSWORD DISABLE	0 = No 1 = Yes				0 = No			

SECTION 6 | Operation, Protections and Troubleshooting

6.5 PROTECTIONS, FAULT MESSAGES AND TROUBLESHOOTING GUIDE

The front panel of the unit has a Red LED marked "FAULT" (13, Fig 2.1). This LED will light up (steady) when the unit registers any of the **FAULT MODE** situations shown in Table 7.1 of EVO-RC Remote Control Manual at Appendix A.

Table 7.1 of EVO-RC Remote Control Manual at Appendix A shows details of protections and associated Fault/Error Messages that will be displayed on the LCD screen of the optional Remote Control EVO-RC.

NOTE: If the optional Remote Control EVO-RC (see Appendix A) is not used, it may be difficult to narrow down the probable cause of the fault.

6.6 POWERING OFF THE UNIT IN FAULT MODE

If the unit is in "Fault Mode", it will be possible to power OFF the unit with the ON/OFF Push Button on the front panel of EVO™ (11, Fig 2.1).

As explained under Section 6.1.3, as long as AC input voltage $> 70 \pm 5$ VAC is present, the unit CANNOT BE POWERED OFF using the ON / OFF Button on the front panel of the unit or on the optional Remote Control EVO-RC *[See Section 3.2.2 of EVO-RC Remote Control Manual at Appendix A]*. In order to power off using the Power ON/Off Button, switch OFF the AC input first.

6.7 12V, 100MA CAPACITY DC SOURCE FOR SIGNALING

A 12V, 100mA capacity DC source has been provided (16, Fig 2.1). This voltage may be routed through the contacts of the Status Relay (14, Fig 2.1) to feed 12V ON / OFF control signal to drive circuits of remote monitoring control of the programmable conditions of operation of the unit *[Refer to Section 4.8.2.5.1 of EVO-RC Remote Control Manual attached at Appendix A]*.

6.8 STANDBY MODE

When the EVO™ is in Standby Mode, it will stop inverting or charging / pass through.

6.8.1 General Information



1. Standby Mode may also be used to temporary halt normal operation of the Inverter Charger without switching OFF the unit completely.
2. EVO-RC Remote Control is required for switching ON/ switching OFF Standby Mode. Switching ON/ OFF of Standby Mode CANNOT be carried out from the ON/ OFF button on the front panel of EVO unless EVO-RC Remote Control has been connected to the EVO unit.

For the Standby Mode to be switched ON, the EVO™ should be in ON condition and should be operating in one of the 3 Operating Modes – "Inverting" or "Charging" or "Power Save" *[See Fig 3.2 of EVO-RC Manual attached at Appendix A]*. When Standby Mode is switched ON, the EVO™ will exit its Operating Mode.

6.8.2 Procedure to Enter and Exit Standby Mode / Status Display in Standby Mode

6.8.2.1 *For procedure to enter and exit Standby Mode, please refer to Section 3.4.1 of EVO-RC Remote Control Manual attached at Appendix A.*

SECTION 7 | Specifications

Models	EVO-2212	EVO-3012	EVO-2224	EVO-4024
INVERTER SECTION				
Output Waveform	Pure Sine Wave			
Input Battery Voltage Range	9.1 - 17 VDC		18.1 - 34 VDC	
Nominal AC Output Voltage	120 VAC \pm 5% ; Single Phase			
Output Frequency	60 Hz/ 50Hz \pm 0.1 Hz (Default 60 Hz \pm 0.1 Hz)			
Total Harmonic Distortion of Pure Sine Wave Form (THD)	< 5%			
Continuous Output Power	2200 VA	3000 VA	2200 VA	4000 VA
Continuous AC Output Current	18A	25A	18A	33A
Surge Power for 1 msec	300% (6600VA, 54A)	300% (9000VA, 75A)	300% (6600VA, 54A)	300% (12,000 VA, 99A)
Surge Power for 100 msec	200% (4400VA, 36A)	200% (6000VA, 50A)	200% (4400VA, 36A)	200% (8000VA, 66A)
Power Boost for 5 sec	150% (3300W)	150% (4500W)	150% (3300W)	150% (6000W)
Power Boost for 30 sec	140% (3080W)	140% (4200W)	140% (3080W)	140% (5600W)
Power Boost for 5 min	120% (2640W)	120% (3600W)	120% (2640W)	120% (4800W)
Power Boost for 30 min	110% (2420W)	110% (3300W)	110% (2420W)	110% (4400W)
Maximum Continuous DC Input Current	266 A	373 A	133 A	266 A
Inverter Efficiency (Peak)	90%	90%	93%	94%
No Load Power Consumption in Standby Mode (Inverting/ charging are suspended)	< 5 W			
No Load Power Consumption in Power Saving Mode	< 8 W			
No Load Power Consumption in Normal Mode (120 VAC Output, Typical)	30 watts		25 watts	
AC INPUT FROM GRID / GENERATOR				
AC Input Voltage	120VAC (60-140VAC +/- 5% selectable)			
AC Input Frequency	60Hz / 50Hz (40 Hz - 70 Hz selectable)			
Maximum Programmable (Default) AC Input Current	5-40A (Default 30A)	5-70A (Default 30A)	5-40A (Default 30A)	5-70A (Default 30A)
TRANSFER CHARACTERISTICS				
Transfer Relay Type and Capacity	SPDT, 40A	DPDT, 70A (2X35A contacts in parallel)	SPDT, 40A	DPDT, 70A (2X35A contacts in parallel)
Transfer Time – Inverter to AC Input Source	< 1 ms (Synchronized transfer at zero crossing)			
Transfer Time – AC Input Source to Inverter	Up to 16 ms (Synchronized transfer at zero crossing)			

SECTION 7 | Specifications

Models	EVO-2212	EVO-3012	EVO-2224	EVO-4024
OPERATING MODES				
Normal (Off-Line) Mode	Grid/Generator Priority (Default) <ul style="list-style-type: none"> Grid/Generator supplies AC loads and charges batteries Inverter is for backup 			
On-Line Mode	Battery / Inverter Priority (Programmable) <ul style="list-style-type: none"> Inverter supplies AC loads even if Grid/Generator is available Grid/Generator takes over when batteries are discharged to "LOW VOLT ALARM" to charge batteries and to power AC loads. AC loads are transferred back to Inverter under various programmed conditions 			
Charger Only Mode	<ul style="list-style-type: none"> Charging & AC Bypass only. No Inverting 			
INTERNAL BATTERY CHARGER SECTION				
AC Input Voltage Range	120 VAC (60 to 140 VAC +/-5% selectable) ; 60 Hz / 50 Hz (40 -70 Hz selectable) ; Single Phase			
Rated Continuous AC Input Current	15A, AC	20A, AC	19A, AC	30A, AC
AC Input Power Factor	> 0.95			
Programmable Bulk Charging Current and Voltage	0 - 100A, DC 12 - 16.5 VDC	0 - 130A, DC 12 - 16.5 VDC	0 - 70A, DC 24 - 33 VDC	0 - 110A, DC 24 - 33 VDC
Charger Efficiency	75%		86%	85%
Charging Profiles & Control	7 types of charging profiles to cover Lead Acid, Lithium Ion & Nickel-Zinc types of batteries: <ul style="list-style-type: none"> Three, 3-Stage Profiles (1 with Adaptive Control) Three, 2-Stage Profiles One, 4-Stage Equalization Profile (with Adaptive Control) 			
Battery Temperature Compensation	<ul style="list-style-type: none"> Battery Temperature Sensor included Compensation Range from -20° C to 60° C 			
EXTERNAL BATTERY CHARGER SECTION (Solar Charge Controller)				
Charging Voltage Range	13 - 16.5 VDC	13 - 16.5 VDC	26 - 33 VDC	26 -33 VDC
Maximum Charging Current	50A			
COOLING, PROTECTIONS AND ALARMS				
Cooling	2 Fans – Temperature Controlled, Variable Speed			
Protections and Alarms	Battery Low Voltage Alarm and Low / Over Voltage Shut Down			
	Shut Down under Input Over Current, Output Over Current, Output Overload and Output Short			
	Transformer and Heat Sink Overheat Shut Down			
	Immunity Against Conducted Electrical Transients in Vehicles			
OPTIONAL REMOTE CONTROL				
Model No.	EVO-RC (see Appendix A)			
Specifications	<ul style="list-style-type: none"> Advanced Features for programming various parameters and modes of operation 2 Rows of 16 Character Alpha Numeric LCD Display for messaging Up to 16 GB SD Card Slot for Data Logging Comes with 10M / 33ft RJ-45 Data Cable 			

SECTION 7 | Specifications

COMPLIANCE				
Safety Compliance	<ul style="list-style-type: none"> • Intertek-ETL listed: Conforms to ANSI / UL STD. 1741 • Intertek-ETL listed: Certified to CAN / CSA STD. C22.2 No. 107.1-01 • Intertek-ETL listed: Conforms to ANSI / UL STD. 458 with Marine Supplement* 			
EMI / EMC Compliance	• Certified to FCC Part 15(B), Class A			
RoHS Compliance	• Certified to RoHS Directive 2011/65/EU			
ENVIRONMENTAL SPECIFICATIONS				
Operating Temperature	-20° C to +60° C (-4° F to 140° F)			
Storage Temperature	-40° C to +70° C (-40° F to 158° F)			
Operating Humidity	0 to 95% RH non condensing			
WEIGHTS AND DIMENSIONS				
Dimensions: W x D x H	325 x 426 x 207 mm; 12.79 x 16.77 x 8.15 in			
Weights:	27 Kg / 59 lb.	29 kg / 64 lb.	26 Kg / 57 lb.	29 Kg / 64 LB

NOTES:

- (1) All AC power ratings in the Inverter Section are specified at Power Factor = 0.95
- (2) All specifications given above are at ambient temperature of 25°C / 77°F unless specified otherwise
- (3) Specifications are subject to change without notice
- (4) *Marine Supplement is valid when installed using Drip Shield. Please see Figs 3.1(a), 3.2(b), 3.3(b) and 3.4(b).

SECTION 8 | Warranty

3 YEAR LIMITED WARRANTY

EVO Series Inverter/Chargers manufactured by Samlex America, Inc. (the “Warrantor”) are warranted to be free from defects in workmanship and materials under normal use and service. The warranty period is 3 years for the United States and Canada, and is in effect from the date of purchase by the user (the “Purchaser”).

Warranty outside of the United States and Canada is limited to 6 months. For a warranty claim, the Purchaser should contact the place of purchase to obtain a Return Authorization Number.

The defective part or unit should be returned at the Purchaser’s expense to the authorized location. A written statement describing the nature of the defect, the date of purchase, the place of purchase, and the Purchaser’s name, address and telephone number should also be included.

If upon the Warrantor’s examination, the defect proves to be the result of defective material or workmanship, the equipment will be repaired or replaced at the Warrantor’s option without charge, and returned to the Purchaser at the Warrantor’s expense. (Contiguous US and Canada only) using a carrier of the warrantor’s choice.

Warranty service shall be performed only by the Warrantor. Any attempt to remedy the defect by anyone other than the Warrantor shall render this warranty void. The warranty does not apply to units with a serial number that has been altered, removed or modified in any way.

There is no warranty for defects or damages to equipment or parts caused by:

- Installation, alternation, inspection or removal
- Normal wear and tear
- Abuse or misuse of the equipment including exposure to excessive heat, salt or fresh water spray, or water immersion
- Corrosion, fire, lightening, biological infestations or Acts of God
- Repairs attempted by anyone other than the Warrantor
- Improper use, contrary to operational instructions provided in product manual
- Shipping or transport

No other express warranty is hereby given and there are no warranties which extend beyond those described herein. This warranty is expressly in lieu of any other expressed or implied warranties, including any implied warranty of merchantability, fitness for the ordinary purposes for which such goods are used, or fitness for a particular purpose, or any other obligations on the part of the Warrantor or its employees and representatives.

There shall be no responsibility or liability whatsoever on the part of the Warrantor or its employees and representatives for injury to any persons, or damage to person or persons, or damage to property, or loss of income or profit, or any other consequential or resulting damage which may be claimed to have been incurred through the use or sale of the equipment, including any possible failure of malfunction of the equipment, or part thereof. The Warrantor assumes no liability for incidental or consequential damages of any kind.

Samlex America Inc. (the “Warrantor”)
www.samlexamerica.com

Contact Information

Toll Free Numbers

Ph: 1 800 561 5885

Fax: 1 888 814 5210

Local Numbers

Ph: 604 525 3836

Fax: 604 525 5221

Website

www.samlexamerica.com

USA Shipping Warehouses

Kent, WA

Plymouth, MI

Canadian Shipping Warehouse

Delta, BC

Email purchase orders to
orders@samlexamerica.com



APPENDIX A



samlexpower®

**Remote Control
for Evolution
Series Inverter/
Charger**

Model: EVO-RC

**Owner's
Manual**

Please read this
manual BEFORE
operating.

Firmware:
Rev 026

EVO™ INVERTER/CHARGER MANUAL | Index

SECTION 1	
Introduction and Layout	3
SECTION 2	
Installation	5
SECTION 3	
Operation	7
SECTION 4	
Parameter Setup	19
SECTION 5	
SD Card	70
SECTION 6	
Monitoring of Operation Using LED and Buzzer	76
SECTION 7	
Fault Messages and Troubleshooting Guide	77
SECTION 8	
Specifications	82
SECTION 9	
Warranty	83

Disclaimer of Liability

UNLESS SPECIFICALLY AGREED TO IN WRITING, SAMLEX AMERICA INC.:

1. MAKES NO WARRANTY AS TO THE ACCURACY, SUFFICIENCY OR SUITABILITY OF ANY TECHNICAL OR OTHER INFORMATION PROVIDED IN ITS MANUALS OR OTHER DOCUMENTATION.
2. ASSUMES NO RESPONSIBILITY OR LIABILITY FOR LOSSES, DAMAGES, COSTS OR EXPENSES, WHETHER SPECIAL, DIRECT, INDIRECT, CONSEQUENTIAL OR INCIDENTAL, WHICH MIGHT ARISE OUT OF THE USE OF SUCH INFORMATION. THE USE OF ANY SUCH INFORMATION WILL BE ENTIRELY AT THE USERS RISK.

Samlex America reserves the right to revise this document and to periodically make changes to the content hereof without obligation or organization of such revisions or changes.

Copyright Notice/Notice of Copyright

Copyright © 2019 by Samlex America Inc. All rights reserved. Permission to copy, distribute and/or modify this document is prohibited without express written permission by Samlex America Inc.

1.0 INTRODUCTION AND LAYOUT

EVO-RC Remote Control allows you to monitor and customize the operating parameters of Samlex Evolution™ Series Inverter/Charger Models EVO-2212, 2224, 3012 and 4024.

It has its own internal Real Time Clock (RTC) and Super Capacitor type of battery for clock operation.

1.1 LAYOUT AND DIMENSIONS

1. LCD Screen - 2 rows of 16 characters each
2. ON/OFF Key
3. Green LED "Status"
4. Red LED "Fault"
5. Navigation Key "Back"
6. Navigation Key "Up"
7. Navigation Key "Down"
8. Navigation Key "Enter"
9. SD Card Slot - FAT16/32 format; Up to 16GB
10. RJ-45 Jack (*At the back-not shown*). See pinout below:

Pin #	Signal
1	12V
2	12V
3	ON/OFF
4	D+
5	D-
6	NC
7	GND
8	GND

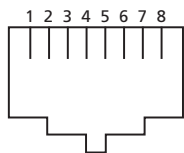

(View - Looking into the Jack)

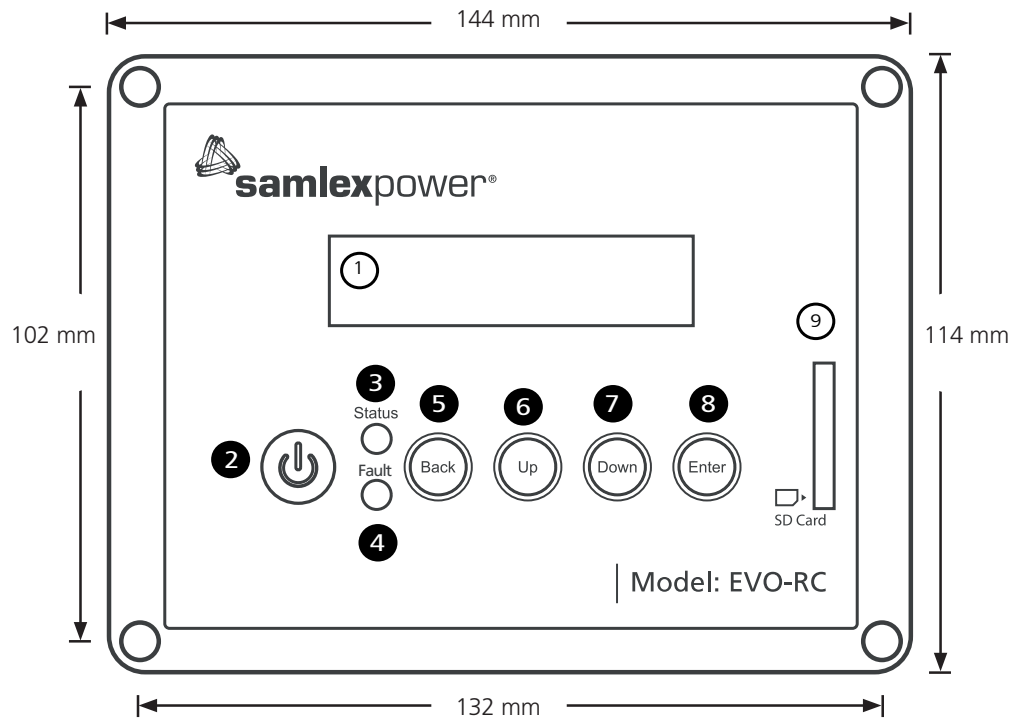

Fig 1.1 Optional Remote Control EVO-RC - Layout & Dimensions

1.2 CONNECTING CABLE

Connecting cable shown in Fig 1.2(a) has been provided to connect EVO-RC Remote Control to EVO Inverter Charger Models EVO-2212 / EVO-3012 / EVO-2224 / EVO-4024. Details of the connecting cable are as follows:

- Length of cable [1, Fig 1.2(a)] : 10m / 33ft
- No. of conductors: 8
- RJ-45 (8P8C) Plugs on either end [2, Fig 1.2(a)]. Pinouts and interconnection of the RJ-45 Plugs are shown in Fig 1.2(b)



Fig 1.2 (a) Connecting Cable

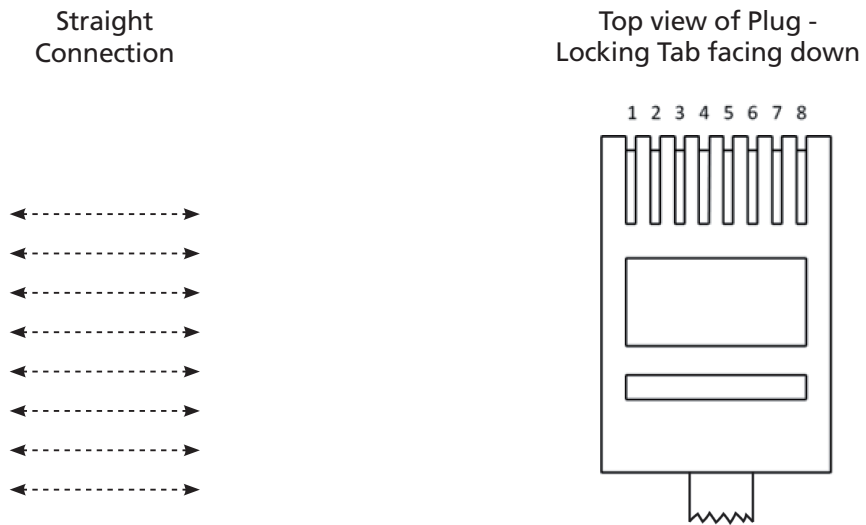

8P 8C, RJ-45 Modular Plug

Fig 1.2 (b) Pinout and Interconnection of RJ-45 Plugs

2.1 INSTALLATION GUIDELINES

The remote control is provided with 10M/33ft, Connecting Cable (*See Section 1.2*). Check the proposed routing distance of the wire and use longer wire, if necessary.

- Flush mounting of the Remote requires appropriate cut-out in the wall/panel (*Dotted line in Fig 2.1*) For this, a paper template has been provided with the unit. Take necessary precautions to ensure any wiring/plumbing running behind the wall/panel is not damaged.
- Route the wire to ensure there are no kinks.
- Use appropriate grommets when the wire is passed through holes in studs/partitions to prevent damage to insulation.

2.1.2 TOOLS REQUIRED

Following tools are recommended:

- Phillips Head Screwdriver
- Knife/Saw
- Paper Template for cut-out (supplied with the unit)
- Level
- Pencil
- Hand Drill
- Drill Bit (2.5mm / #39)

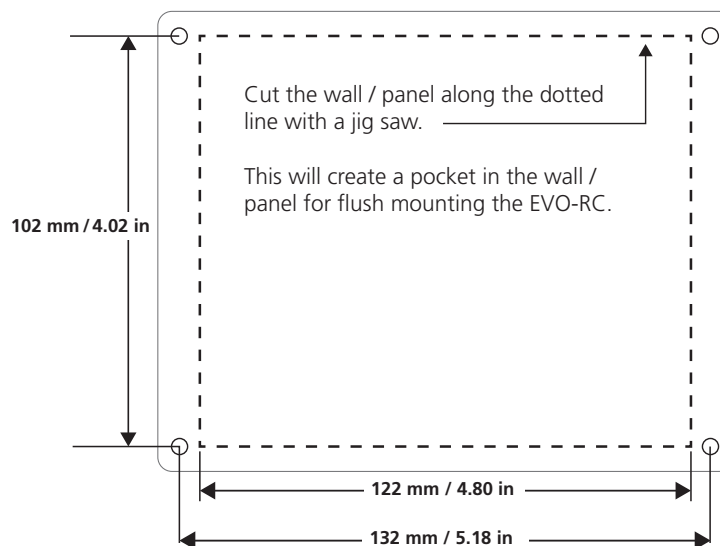

Fig 2.1 EVO-RC Remote Cutout Dimensions for Wall/ Panel Mounting

2.2 FLUSH MOUNT INSTALLATION

To flush mount, the wall opening must have at least a 2" (5 cm) depth to make room for the remote and cable. Also, the thickness of wall/panel board at the place of mounting should not be more than 13 mm to ensure that the RJ-45 jack opening is not obstructed (see Fig. 2.3).

1. Cut an opening in the wall using the supplied paper template (*Based on Fig 2.1*).
2. Drill four pilot holes (use 2.5mm diameter/#39 drill bit) for the 4 screws (*3mm diameter, 16mm long*) that will attach the remote to wall (refer to Figure 2.1 for hole locations and dimensions).
3. Route one end of the cable through wall opening to the EVO™ Inverter/Charger, and then plug it into the RJ-45 Remote Control Jack port on the EVO™ Inverter/Charger.

4. Take the other end of remote cable and plug it into the RJ-45 Jack at the back of the EVO-RC (**Fig. 2.3**).
5. Check the remote display to ensure the Power-up self test initiates.
6. If the self test is successful, secure the EVO-RC to the wall using the four screws (**Fig 2.2**)

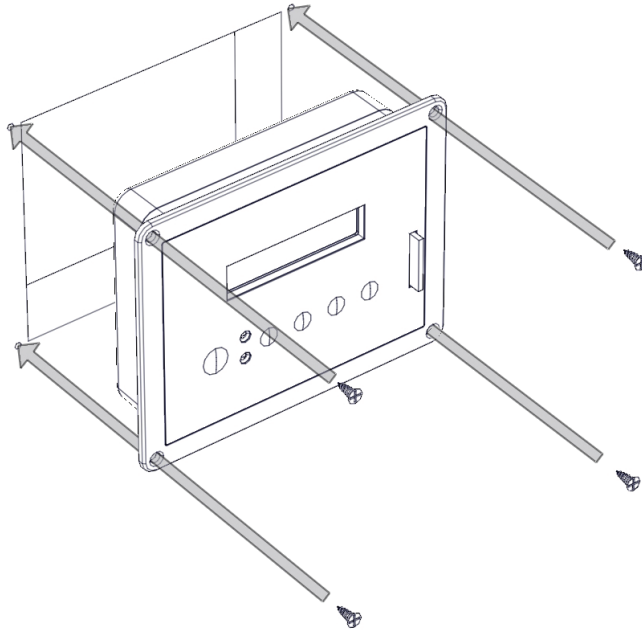

Flush mounting the EVO-RC on the wall with 4pcs, $\Phi 3\text{mm}$ self-tapping, flat head screws (supplied with the unit).

Fig 2.2 EVO-RC Flush Mounting

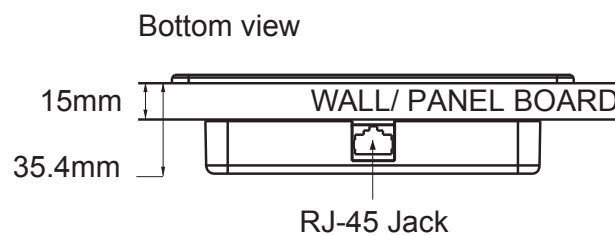

The thickness of the wall/panel board at the place of mounting should not be more than 15mm to ensure that the RJ-45 jack opening is not obstructed.

Fig 2.3 Wall/Panel Thickness

3.0 GENERAL INFORMATION

EVO-RC Remote Control provides the user with the ability to modify EVO™ Inverter/Charger's operating parameters. The default settings in EVO™ Inverter/Charger are adequate for some installations but may have to be modified for others. This Section provides details on the remote functions, status and menu maps and displays, fault messages and parameter settings.

3.1 NAVIGATING THE REMOTE

The EVO-RC provides menu items and adjustable settings to configure your EVO™ Inverter/Charger to your specific parameters. Please refer to the layout at Fig 1.1.

- **LCD Display (1)** – The 2-line (16 characters each) LCD display shows status and information for the EVO™ Inverter/Charger. All Setup Menus and faults also appear on the LCD display.
- **ON/OFF Key (2)** – The ON/OFF Key is used for switching ON/switching OFF the EVO™ Inverter/Charger.
- **Navigation Keys (5, 6, 7, 8)** – These four Keys allow simple access to menu items that assists configuring, monitoring, and troubleshooting the EVO™ Inverter/Charger.
 - **Navigation Key Functions:**
 - **Back** – Return to previous selection
 - **Up** – Scroll to higher Screen Nos. / Parameter Group Nos. in various Menu Maps
 - **Down** – Scroll to lower Screen Nos. / Parameter Group Nos. in various Menu Maps
 - **Enter** – Enter the selected option
- **Status** – Green LED indicator for indicating operating status (*See details at Section 6, Table 6.1*)
- **Alarm (Fault)** – Red LED indicator for indicating fault conditions (*See details at Section 6, Table 6.1*)
- **SD Card socket** – This slot supports SD memory card (up to 16GB; FAT 16/32). The SD Card is used for (i) Data logging of EVO™ Inverter/Charger's operational statistics and events and (ii) Saving and uploading of programmed parameters (*See Section 5: SD Card*)

3.2 POWER ON / POWER OFF



INFO

a) **Minimum battery voltage required for initiating manual switching ON of the unit is as follows:**

- **12V units ----- Higher than 9V**
- **24V units ---- Higher than 18V**

b) Please note that this unit is designed to **POWER ON AUTOMATICALLY** if (i) AC voltage of $70V \pm 5 VAC$ is available at the AC Input Terminals and (ii) DC input voltage is $> 12V$ for 12V versions of EVO™ and $>24V$ for 24V versions of EVO™. If the AC input voltage and frequency are within the programmed limits, the unit will automatically operate in "Charging Mode". If the AC input voltage and frequency are not within the programmed limits, the unit will operate in "Inverting" Mode. Further, as long as AC input voltage $> 70 \pm 5 VAC$ is present, the unit **CANNOT BE POWERED OFF** using the ON / OFF Button on the front panel of the unit or on the Remote Control EVO-RC. Switch OFF the AC input first if the unit is required to be powered off. However, if the unit is in "Fault Mode", it will be possible to power OFF the unit with the help of the ON/OFF Push Button.

c) Before proceeding, confirm that the unit is NOT in "Standby" Mode. If it is in "Standby Mode", the "Status" LED (*3, Fig 1.1*) will flash once every 5 sec and the LED screen will display one of the "Standby Mode" Screens show in Figs 3.2 (*Column 2, GROUP 1*). Press the On/Off Push Button (*2, Fig 1.1*) on the EVO-RC to exit the "Standby Mode" to the current operating mode. Refer to Section 3.4 for more details on "Standby Mode".

3.2.1 Power ON - AC INPUT IS NOT PRESENT

The sequence given below in Fig 3.1(a) is applicable *when there is no AC input* and the unit is switched ON.

Press On/Off Key and hold for 2 second to turn the EVO™ Inverter/Charger ON.

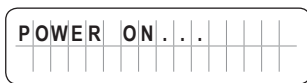

Screen (a)



Screen (b)

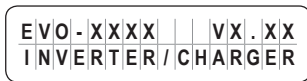

Screen (c)



Screen (d)

When the EVO™ Inverter/Charger is OFF and the On/Off Key is pressed and held, the LCD screen shows "POWER ON..." [Screen (a)] and the Status LED flashes 3 times. On/Off key may be released now. After 2 seconds, EVO-RC starts to search for the communication ID of the EVO™ Inverter/Charger it is attached to. The LCD screen shows "SEARCHING ID ..." [Screen (b)] and the ID number which is found is shown at the end of the line. When the default ID of "1" is found, the display will then show the EVO™ Inverter/Charger Model No. and firmware version (3 digit number X.XX) [Screen (c)]. The screen will then change to the Inverting Mode Screen [Screen (d)].

**Fig 3.1(a) Power On Sequence
(No AC Input)**

3.2.2 Power OFF - AC INPUT IS NOT PRESENT

NOTE:

If the EVO™ Inverter/Charger has AC input voltage over 70 ± 5 VAC available at AC input terminals, the Power OFF function is disabled and the unit will remain in the ON condition if the power off sequence is attempted. The AC input must be removed before the unit can be powered OFF.

The sequence given below in Fig 3.1(b) is applicable when the unit is required to be powered off *when no AC input is present*.

Press On/Off Key and hold for 5 seconds to turn OFF the EVO™ Inverter/Charger.

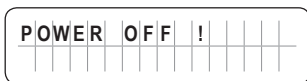

When EVO™ Inverter Charger is ON and the On/Off key is pressed and held for minimum of 5 seconds, the LCD screen will show "POWER OFF !" and both the Status and Alarm/ Fault LEDs will turn ON. Now release the On/Off key (**please note that Power Off sequence will be completed and display "POWER OFF !" will disappear only when the On/Off key is released**).

**Fig 3.1(b) Power Off Sequence
(No AC Input)**

3.3 DATE AND TIME SETUP

Set date and time as per procedure given at Section 4.9: "Group 6 Parameter Setup: Time Setting".

3.4 STANDBY MODE

When the EVO™ is in Standby Mode, inverting or charging / AC pass through will be suspended.



INFO

Standby Mode may be used to temporary halt normal operation of the Inverter/Charger without switching OFF the unit completely.

For the Standby Mode to be switched ON, the EVO™ should be in ON condition and should be operating in one of the 4 Operating Modes – "Inverting" or "Charging", "Power Saving" or "Online" (See Fig 3.2). When Standby Mode is switched ON, the EVO™ will suspend its Operating Mode.

3.4.1 Procedure to Enter and Exit Standby Mode / Status Display in Standby Mode



INFO

- EVO-RC Remote Control will be required to be connected to the EVO Inverter-Charger Unit to enter Standby Mode as explained at Section 3.4.1.1 below. Once Standby Mode has been entered using EVO-RC Remote Control, it can **ALSO** be switched off using the On/Off Push Button on the front panel of the EVO Inverter-Charger Unit (See Section 3.4.1.2)
- If EVO-RC Remote Control has **NOT** been connected to the EVO Inverter-Charger Unit, Standby Mode cannot be entered using the On/Off Push Button on the front panel of the EVO Inverter-Charger Unit

3.4.1.1 Entering Standby Mode Using Remote Control EVO-RC: Changing over from any Operating Mode ("Inverting", "Charging" or "Power Save") to Standby Mode can be carried out with the help of Remote-Control EVO-RC as follows:

- From any Operating Mode Screen ("Inverting", "Charging" or "Power Save"), press the On/Off Push Key (2, Fig 1.1) momentarily (0.1 sec)
- Screen 1 below will be displayed first for 1 sec followed by Screen 2 below for 1 sec. **This display sequence will be displayed 2 times and then, the screen will go back to the Operating Mode Screen.**
 - If Standby Mode is required to be activated, press the On/Off Push Key (2, Fig 1.1) momentarily (0.1 sec)
 - If Standby Mode is not required to be activated, press the Back Key (5, Fig 1.1) momentarily (0.1 sec)

Screen 1:

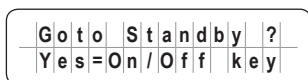

Screen 2:

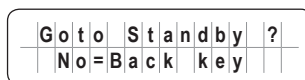

c) On entering Standby Mode, the following will be displayed:



- i. **On the EVO-RC:** The LCD will show the 1st screen of the 7 Standby Mode Screens (See Screens 1 to 7 of screens shown under Group 1, Standby Mode in Fig 3.2) and Status LED (3, Fig 1.1) will blink once every 5 sec
- ii. **On the Front Panel of EVO Inverter-Charger:** The Green LED marked "ON" (12, Fig 2.1 of the attached EVO-1212/3012/2224/4024 Inverter Charger Manual) will blink once every 5 sec. Red LED marked "FAULT" (13, Fig 2.1 of the attached EVO-1212/3012/2224/4024 Inverter-Charger Manual) and Buzzer will be off

3.4.1.2 Exiting Standby Mode: Standby Mode can be exited as follows:

- *Using EVO-RC:* To exit Standby Mode using Remote Control EVO-RC, press the On/Off Key (2, Fig 1.1) momentarily (0.1 sec).
- *From Front Panel of EVO Inverter Charger:* It is **NOT POSSIBLE** to exit Standby Mode by momentary pressing of the On/Off Push Button on the front panel of EVO (11, Fig 2.1 of the attached EVO-1212/3012/2224/4024 Inverter Charger Manual) if EVO-RC Remote in **NOT** connected to EVO.



INFO

Please note that when Standby Mode is exited, EVO Inverter-Charger Unit will execute the programmed Operating Mode from the beginning. *It will **NOT** start from the last condition of the operating stage it was in when Standby Mode was activated.*

3.5. FAULT MESSAGES & CLEARING FAULTS

If any fault occurs, the LCD screen will display the Fault Message and the Red LED "Fault" will be lighted. Refer to Table 7.1 in Section 7 for details of various fault messages and procedure to clear the fault.



CAUTION!

The cause of the fault should be removed before the unit is restarted.



ATTENTION!

La cause de la panne doit être retiré avant un redémarrage de l'appareil.

3.6 OPERATING MODES AND ASSOCIATED LCD DISPLAY SCREENS

3.6.1 Menu Maps for Operating Mode Screens

When the unit is operating normally, the LCD Screen will display the name of the Operating Mode and values of various associated operating parameters. As all the operating parameters associated with a particular Operating Mode cannot be displayed in one screen, multiple screens are available that can be accessed by scrolling the screens using the Up and Down Keys. For ease of navigating through the various screens, all the screens covering a particular Operating Mode have been arranged in the associated Menu Map. Table 3.1 shows the names of the Operating Modes and the Fig Nos. of the associated Menu Maps.

Table 3.1 Operating Modes and Associated Menu Maps/ LCD Display Screens		
Operating Mode	Description	Section and Fig No. of Associated Menu Map
STANDBY MODE	Standby Mode: No output, No AC bypass, No Charging	Section 3.6.2 Fig 3.2
INVERTING MODE	Unit is operating as an inverter	Section 3.6.2 Fig 3.2
CHARGING MODE	Unit is operating as a battery charger and passing through the AC input to the loads	Section 3.6.2 Fig 3.2
POWER SAVING MODE	Unit is in Power Saving Mode	Section 3.6.2 Fig 3.2
ON LINE	Unit is in On Line Mode	Section 3.7 Fig 3.3(a) to 3.3(d)
CHARGER ONLY	<i>Applicable when Parameter "ONLINE MODE", Option: 2=Charger is selected.</i> Provides charging and pass through when the AC input is available. <i>No inverting when the AC input is not available.</i>	Section 3.8 Fig 3.4(a) & 3.4(b)
CHGR STOP BY BMS	<i>Applicable when Parameter "BATTERY TYPE", Option: 1=Lithium is selected.</i> This mode is activated when the Lithium Battery Management System (BMS) sends command to EVO™ (contact closure signal) to stop charging to prevent battery over voltage or over temperature.	Section 3.9 Fig 3.5
INV STOP BY BMS	<i>Applicable when Parameter "BATTERY TYPE ", Option: 1=Lithium is selected.</i> This mode is activated when the Lithium Battery Management System (BMS) sends command to EVO™ (contact closure signal) to stop inverting to prevent deep discharge of the battery.	Section 3.10, Fig 3.6

3.6.2 Menu Map for Standby/ Inverting/ Charging/ Power Save Modes

Fig 3.2 shows Menu Map for the 4 main Operating Modes: (i) STANDBY MODE (ii) INVERTING MODE (iii) CHARGING MODE and (iv) POWER SAVING MODE.

Any screen within Menu Map in Fig 3.2 for the 4 Main Operating Modes can be identified by 2 co-ordinates: Operating Mode Group No (Column) and Display Screen No (Row).

Menu Maps/ Display Screens detailed in Table 3.2 are self-explanatory.

3.6.3 Charging Profile and Charging Stage information included in Charging Mode Display Screens

When the unit is operating in Charging Mode, all the relevant operating information related to this mode is displayed through 19 scrollable screens (*Screen Nos 1 to 19*) as shown in Fig 3.2 under Column 4 - "GROUP 3: CHARGING MODE"

The left corner of the 1st line of the display screen shows "CHARGING" and the right corner shows coded / abbreviated information as follows:

- a) The first character of the right-hand corner display indicates the code for the Charging Profile that is active:
 - i. Numeral 0 to 5 for 6 options for 3-Stage / 2-Stage Charging Profiles (*Refer to Section 4.4.2.21 for details*), or
 - ii. Letter “E” for 4-Stage Adaptive Profile for Equalization (*Refer to Section 4.4.2.12*)
- b) The other portion of the right-hand corner display provides the following coded information pertaining to the Charging Stage that is active:
 - **CC** for **C**onstant **C**urrent Stage
 - **CV** for **C**onstant **V**oltage 2nd Stage in 3-Stage / 2-Stage Charging Profiles
 - **E-CVA** for **C**onstant **V**oltage **A**bsorption Stage in 4-Stage Adaptive Charging Profile for Equalization
 - **E-CVE** for **C**onstant **V**oltage **E**qualization Stage in 4-Stage Adaptive Charging Profile for Equalization
 - **FLOAT** for Float Stage
 - **OFF** for charger off

Consolidated information related to the 1st line right hand corner display is given in Table 3.2 below:

1 st line, right corner display under “GROUP 3: CHARGING MODE” screens in Fig 3.2	Description
0-CC	Constant Current, Bulk Stage, Parameter CHARGING PROFILE option : 0=3Stg Adaptiv
1-CC	Constant Current, Bulk Stage, Parameter CHARGING PROFILE option : 1=3Stage Type1
2-CC	Constant Current, Bulk Stage, Parameter CHARGING PROFILE option : 2=3Stage Type2
3-CC	Constant Current, Bulk Stage, Parameter CHARGING PROFILE option : 3=2Stage Type1
4-CC	Constant Current, Bulk Stage, Parameter CHARGING PROFILE option : 4=2Stage Type2
5-CC	Constant Current, Bulk Stage, Parameter CHARGING PROFILE option : 5=2Stage Type3
E-CC	Constant Current, Bulk stage of 4-Stage Adaptive Profile for Equalization
0-CV	Constant Voltage, Absorption stage, Parameter CHARGING PROFILE option : 0=3Stg Adaptiv
1-CV	Constant Voltage, Absorption Stage, Parameter CHARGING PROFILE option : 1=3Stage Type1
2-CV	Constant Voltage, Absorption Stage, Parameter CHARGING PROFILE option : 2=3Stage Type2
3-CV	Constant Voltage, Absorption Stage, Parameter CHARGING PROFILE option : 3=2Stage Type1
4-CV	Constant Voltage, Absorption Stage, Parameter CHARGING PROFILE option : 4=2Stage Type2
5-CV	Constant Voltage, Absorption Stage, Parameter CHARGING PROFILE option : 5=2Stage Type3
E-CVA	Constant Voltage, Absorption Stage of 4-Stage Adaptive Profile for Equalization
E-CVE	Constant Voltage, Equalization Stage of 4-Stage Adaptive Profile for Equalization
0-FLOAT	Float Stage, Parameter CHARGING PROFILE option : 0=3Stg Adaptiv
1-FLOAT	Float Stage, Parameter CHARGING PROFILE option : 1=3Stage Type1
2-FLOAT	Float Stage, Parameter CHARGING PROFILE option : 2=3Stage Type2
3-OFF	Charger Off, AC bypass, Parameter CHARGING PROFILE option : 3=2Stage Type1
5-OFF	Charger Off, AC bypass, Parameter CHARGING PROFILE option : 5=2Stage Type3
CHGR STOP BY BMS	Charging switches off when Pins 4 and 5 of Battery Temperature Sensor Jack (<i>6 in Fig 2.1 of Manual for EVO-2212/3012/2224/4024</i>) are shorted by control signal from Lithium Ion Battery Management System (BMS). (<i>For details, please refer to Section 5.11.2 of the attached Owner’s Manual for EVO-2212/3012-2224/4024</i>)

For example, in Fig 3.2, the 1st line of information under Column 4 (GROUP 3: CHARGING MODE) shows “0-CC” in the right corner. This means that the unit is charging under the following conditions:

- CHARGING PROFILE: Option “0=3Stg Adaptiv” i.e. 3-Stage Adaptive Charging Profile (*Refer to Section 5.7 of the attached Owner’s Manual for EVO/2212/3012/2224/4024 for details on this profile*)
- Charging Stage: “CC” i.e. **C**onstant **C**urrent Bulk Stage

SECTION 3 | Operation

APPENDIX A

NOTE: See Table 7.1 for fault messages

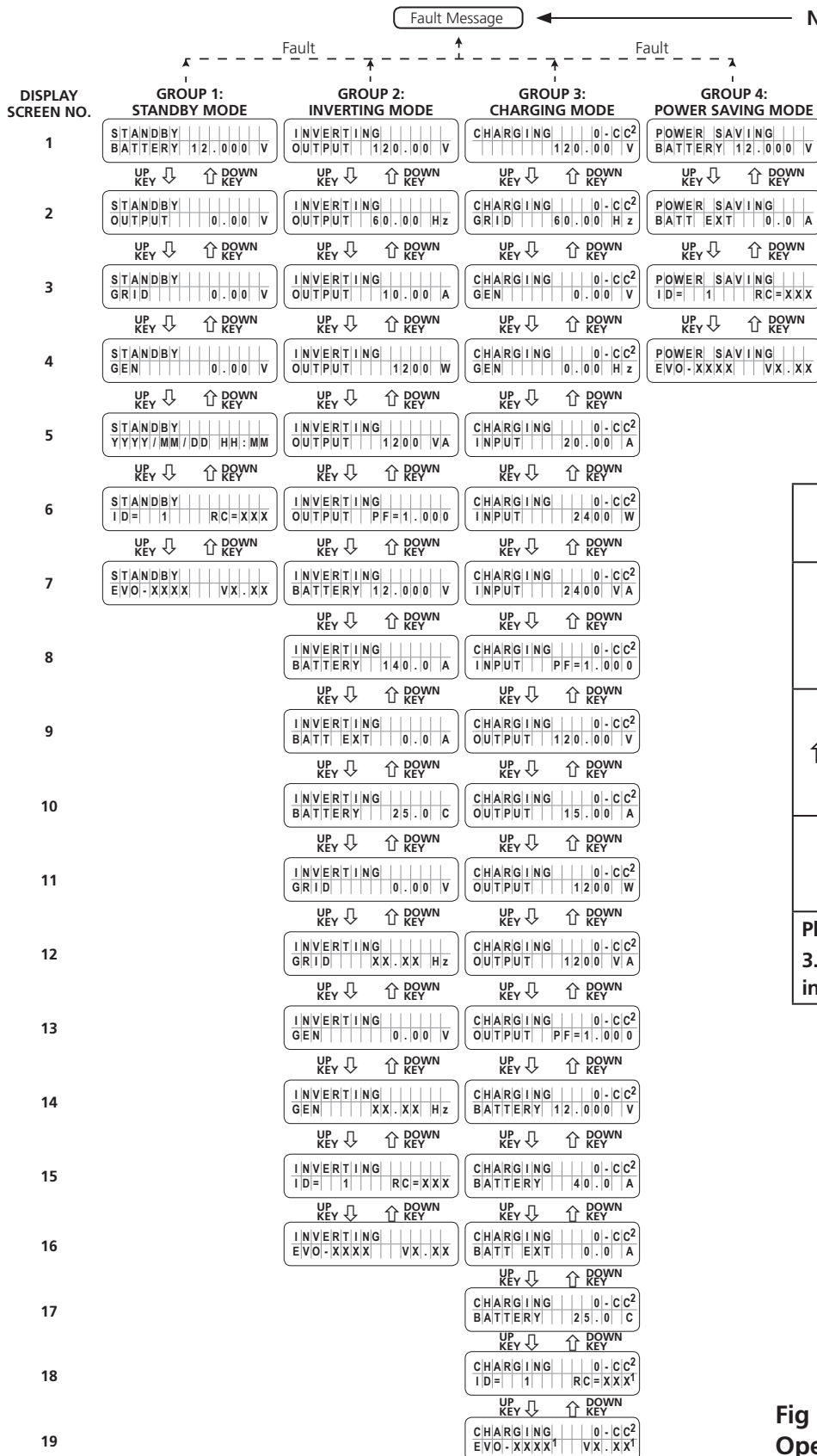



LEGEND FOR FIG 3.2	
UP KEY ↓	Move downwards to higher Display Screen No. (See Note 3 under "NOTES FOR FIG 3.2" on Page 14)
↑ DOWN KEY	Move upwards to lower Display Screen No. (See Note 3 under "NOTES FOR FIG 3.2" on Page 14)
1,2	Refer to Notes 1 & 2 under "NOTES FOR FIG 3.2" on Page 14
Please Refer to "NOTES FOR FIG 3.2" on Page 14 for additional information related to this FIG 3.2	

Fig 3.2 Menu Map For Overall Operating Mode Display Screens

NOTES FOR FIG 3.2:

- The 3-digit No. XXX in "RC-XXX" indicates the Firmware Revision No. for the Remote Control EVO-RC
 - The 4-digit No. XX.X in EVO-VX.XX denotes the Firmware Revision No. for the EVO™ Inverter/Charger
 - The 4-digit No. XXXX in EVO-XXXX denotes the Model No. of Evolution™ Series Inverter/Charger i.e. EVO-2212 / 2224 / 3012 / 4024
- The display on the top right corner of the 19 Display Screens (*Display Screen Nos. 1 to 19*) under "CHARGING" Mode (*Column 4, Group 3*) indicates the Charging Profile & the Charging Stage. *Refer to Section 3.6.2 & Table 3.2 for details.*
- The following convention has been used to show up and down scrolling of the screens:

UP  KEY	Press Up Key to scroll to the next screen in the downward direction towards higher Screen Nos
 DOWN KEY	Press Down Key to scroll to the previous screen in the upward direction towards lower Screen Nos

- See Section 3.7 for information on Operating Mode Display Screens when the unit is in On-Line Mode
- Parameter values shown in the screens are the default values for the 12V versions i.e. EVO-2212/3012.

3.7 MENU MAPS FOR ON-LINE MODE SCREENS



INFO

Please refer to the following for additional information on "On-Line Mode":

- Section 4.8.5.2 of the attached Owner's Manual for EVO-2212/ 3012/ 2224/ 4024 for description and application of "On-Line Mode"
- Section 4.4.2.13.2 for selecting programming option "1=On-Line" for On-Line Mode under programming Parameter "MODE" (*Section 4.4.2.13*)

On-Line Mode Screens will be similar to the Off-line Mode Screens shown in Fig 3.2 for Menu Map for Overall Operating Mode Screens. Each On-Line Mode Screen will show "ONLINE" in the right corner of the first line of the screen. Each screen will alternate every 2 sec between Off-Line Mode Screen and On-Line Mode Screen. Examples of Screen 1 of each of the 4 Operating Modes is shown in Figs 3.3(a) to 3.3(d) below:



The above 2 Display Screens alternate every 2 sec

Fig 3.3 (a) Example of Display Screen No. 1 of 7 Display Screens in Menu Map for "GROUP 1: STANDBY MODE" (See Column 2 of Fig 3.2)



The above 2 Display Screens alternate every 2 sec

Fig 3.3 (b) Example of Display Screen No. 1 of 16 Display Screens in Menu Map for "GROUP 2: INVERTING MODE" (See Column 3 of Fig 3.2)

CH	ARG	I	N	G					0	.	CC
									1	2	0
									.	0	0
											V

CH	ARG	I	N	G		ON	L	I	N	E	
									1	2	0
									.	0	0
											V

The above 2 Display Screens alternate every 2 sec

Fig 3.3 (c) Example of Display Screen No. 1 of 19 Display Screens in Menu Map for "GROUP 3: CHARGING MODE" (See Column 4 of Fig 3.2)

PO	WE	R	SA	V	I	N	G				
									1	2	0
									.	0	0
											V

P	W	R	S	A	V	E		ON	L	I	N	E
									1	2	0	0
									.	0	0	0
												V

The above 2 Display Screens alternate every 2 sec

Fig 3.3 (d) Example of Display Screen No. 1 of 4 Display Screens in Menu Map for "GROUP 4: POWER SAVE MODE" (See Column 5 of Fig 3.2)

3.8 MENU MAP FOR "CHARGER ONLY" MODE SCREENS



INFO

Refer to Section 4.4.2.13.3 regarding programming option "2=CHARGER ONLY" under programming parameter "MODE" ([Section 4.4.2.13](#))

3.8.1 When this option is selected, the EVO will remain in "Charging Mode" as long as qualified AC input voltage is available. During the time AC input is available, 19 scrollable Operating Mode Screens for "CHARGING MODE" will be available as per Menu Map shown in Fig 3.4(a) on page 16 (*This Menu Map is also shown in the Menu Map in Fig 3.2 at Column 4 under heading "GROUP 3, CHARGING MODE"*)

3.8.2 In case AC input voltage fails or is switched off, EVO will NOT change over to "Inverting Mode" but will enter "STANDBY MODE" (**NOTE: AC side loads will lose AC power**). During the time AC input is NOT available, 7 scrollable Operating Mode Screens for STANDBY MODE will be displayed as shown in Menu Map at Fig 3.4(b) on page 16. (*Also shown in Menu Map at Fig 3.2 in Column 2 under heading "GROUP 1, STANDBY MODE"*)

3.8.2.1 If attempt is made to exit "STANDBY MODE" by momentarily pressing the On/Off Key, message

CH	ARG	E	R		ONLY						

will be seen for some time and the screen will revert back to the "STANDBY MODE" Screen that was being displayed

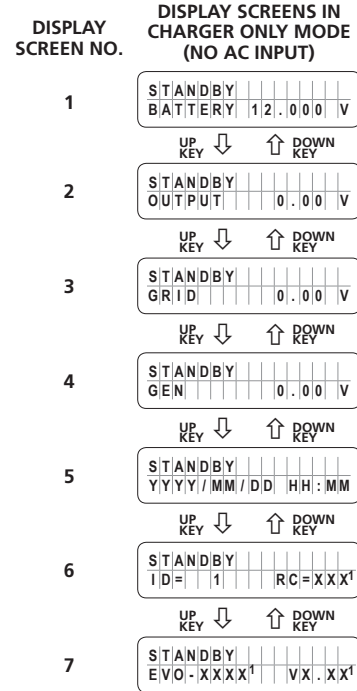
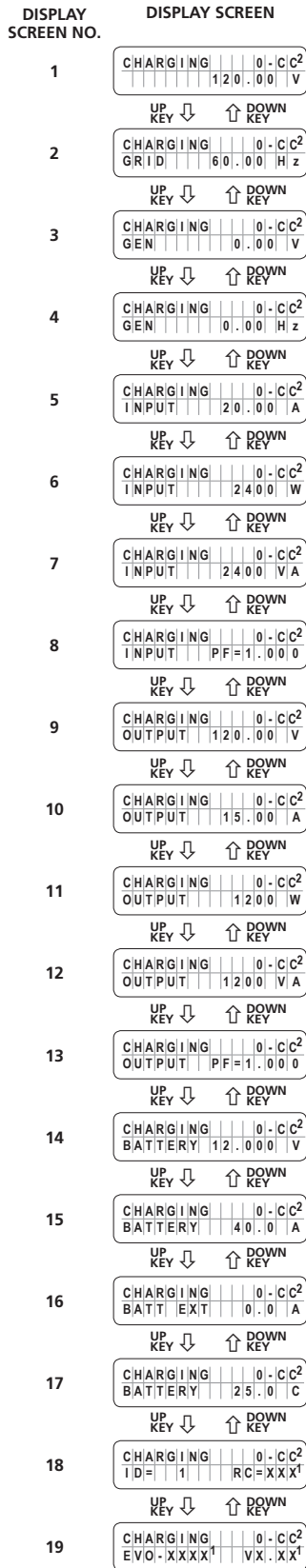

Fig 3.4 (b) Menu Map of Operating Mode Screens in Charger Only Mode (No AC input)

LEGEND FOR FIGS 3.4(a) and 3.4(b):

- The 3-digit No. XXX in "RC-XXX" indicates the Firmware Revision No. for the Remote Control EVO-RC
 - The 4-digit No. XX.X in EVO-VX.XX denotes the Firmware Revision No. for the EVO™ Inverter/Charger
 - The 4-digit No. XXXX in EVO-XXXX denotes the Model No. of Evolution™ Series Inverter/Charger
i.e. EVO-2212 / 2224 / 3012 / 4024
- The display on the top right corner of the 19 Display Screens (*Display Screen Nos. 1 to 19*) in Fig 3.4(a) indicates the Charging Profile & the Charging Stage. *Refer to Section 3.6.2 & Table 3.2 for details.*
- The following convention has been used to show up and down scrolling of the screens:

UP KEY ↓	Press Up Key to scroll to the next screen in the downward direction towards higher Screen Nos
↑ DOWN KEY	Press Down Key to scroll to the previous screen in the upward direction towards lower Screen Nos
- Parameter values shown in the screens are the default values for the 12V versions i.e. EVO-2212/3012.

Fig 3.4 (a) Menu Map of Operating Mode Screens in Charger Only Mode (AC input is available)

3.9 MENU MAP FOR "CHARGER STOP BY BMS" MODE SCREENS



INFO

For background information, refer to Section 4.4.2.22.2 regarding "Stop Charging" control by Lithium Ion Battery Management System (BMS) for on/off control of charging operation of EVO Inverter Charger

When BMS activates "Stop Charging" signal (*The Drain-Source terminals of the BMS will close and short Pins 1/2/3/4 and 5/6/7/8 of RJ-45 Jack marked "Battery Temp Sensor" on the front panel of EVO*), EVO will stop charging (**Internally, EVO will be in Charging Mode, but the charging current will be reduced to 0A**). 19 scrollable display screens will be available to show the status of various parameters as shown in the Menu Map at Fig 3.5 on the left.

NOTE: The 19 "CHGR STOP BY BMS" display screens shown in Fig 3.5 on the left are the same as the 19 display screens shown for Menu Map for screens for "Charging Mode" (Fig 3.2 – Column 3 under heading "GROUP 3: CHARGING MODE") but with the 1st line replaced with "CHGR STOP BY BMS"

DISPLAY SCREEN NO.	DISPLAY SCREEN
1	CHGR STOP BY BMS 120.00 V UP KEY ↓ ↑ DOWN KEY
2	CHGR STOP BY BMS GRID 60.00 Hz UP KEY ↓ ↑ DOWN KEY
3	CHGR STOP BY BMS GEN 0.00 V UP KEY ↓ ↑ DOWN KEY
4	CHGR STOP BY BMS GEN 0.00 Hz UP KEY ↓ ↑ DOWN KEY
5	CHGR STOP BY BMS INPUT 20.00 A UP KEY ↓ ↑ DOWN KEY
6	CHGR STOP BY BMS INPUT 2400 W UP KEY ↓ ↑ DOWN KEY
7	CHGR STOP BY BMS INPUT 2400 VA UP KEY ↓ ↑ DOWN KEY
8	CHGR STOP BY BMS INPUT PF=1.000 UP KEY ↓ ↑ DOWN KEY
9	CHGR STOP BY BMS OUTPUT 120.00 V UP KEY ↓ ↑ DOWN KEY
10	CHGR STOP BY BMS OUTPUT 15.00 A UP KEY ↓ ↑ DOWN KEY
11	CHGR STOP BY BMS OUTPUT 1200 W UP KEY ↓ ↑ DOWN KEY
12	CHGR STOP BY BMS OUTPUT 1200 VA UP KEY ↓ ↑ DOWN KEY
13	CHGR STOP BY BMS OUTPUT PF=1.000 UP KEY ↓ ↑ DOWN KEY
14	CHGR STOP BY BMS BATTERY 12.000 V UP KEY ↓ ↑ DOWN KEY
15	CHGR STOP BY BMS BATTERY 40.00 A UP KEY ↓ ↑ DOWN KEY
16	CHGR STOP BY BMS BATT EXT 0.00 A UP KEY ↓ ↑ DOWN KEY
17	CHGR STOP BY BMS BATTERY 25.00 C UP KEY ↓ ↑ DOWN KEY
18	CHGR STOP BY BMS ID= 1 RC=XXXX UP KEY ↓ ↑ DOWN KEY
19	CHGR STOP BY BMS EVO-XXXX V.X.XX

LEGEND FOR FIG 3.5	
UP KEY ↓	Press Up Key to scroll the screen in the downward direction towards higher Screen Nos
↑ DOWN KEY	Press Down Key to scroll the screen in the upward direction towards lower Screen Nos
NOTE: Parameter values shown in the various display screens are the default values for 12V versions i.e. EVO-2212/3012	

Fig 3.5 Menu Map for Display Screens during "Charger Stop by BMS"

3.10 MENU MAP FOR "INVERTER STOP BY BMS" MODE SCREENS



INFO

For background information, refer to Section 4.4.2.22.2 regarding "Stop Inverting" control by Lithium Ion Battery Management System (BMS) for on/off control of inverting operation of EVO Inverter Charger

When BMS activates "Stop Inverting" signal (The Drain-Source terminals of the BMS will close and short Pins 1/2/3/4 and 5/6/7/8 of RJ-45 Jack marked "Battery Temp Sensor" on the front panel of EVO), EVO will stop inverting (Internally, EVO will be in Standby Mode). 7 scrollable display screens will be available to show the status of various operating parameters as shown in the Menu Map at Fig 3.6 on the right:

NOTE: The 7 "INV STOP BY BMS" display screens shown in Fig 3.6 on the right are the same as the 7 display screens shown for Menu Map for "Standby Mode" (Fig 3.2 – Column 2 under heading "GROUP 1: STANDBY MODE") but with the 1st line replaced with "INV STOP BY BMS"

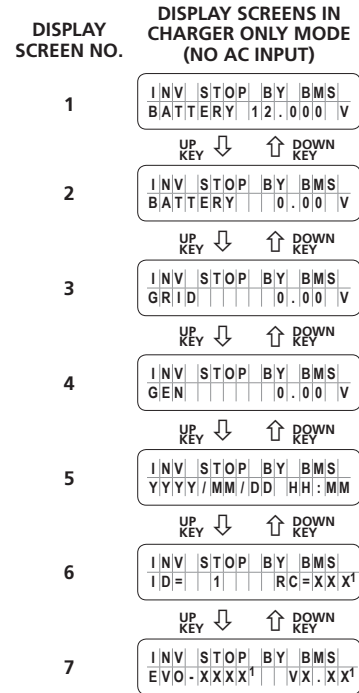

LEGEND FOR FIG 3.6	
	Press Up Key to scroll the screen in the downward direction towards higher Screen Nos
	Press Down Key to scroll the screen in the upward direction towards lower Screen Nos

Fig 3.6 Menu Map for Display Screens during "Charger Stop by BMS" Mode

4.1 PARAMETER SETUP MENU MAPS

4.1.1 General Information

Up to 63 operating parameters (*Figs 4.1 and 4.2*) can be programmed to suit the desired operating conditions.

The 63 programming parameters have been arranged under 7 "PARAMETER GROUPS" (*Displayed under heading "SELECT GROUP"*) as shown in Parameter Setup Menu Map for "PARAMETER GROUPS" 1 - 4 in Fig 4.1 & for "PARAMETER GROUPS" 5 - 7 in Fig 4.2.



INFO

Parameter Setup Menu Maps in Figs 4.1 & 4.2 have been explained using LCD screen displays with information as seen on the actual LCD screens.

- All values shown in the second row of setup screen displays are the default parameters for EVO-2212/3012.
- All voltage values related to battery voltages are the default values for 12V versions i.e. EVO-2212/3012

SECTION 4 | Parameter Setup

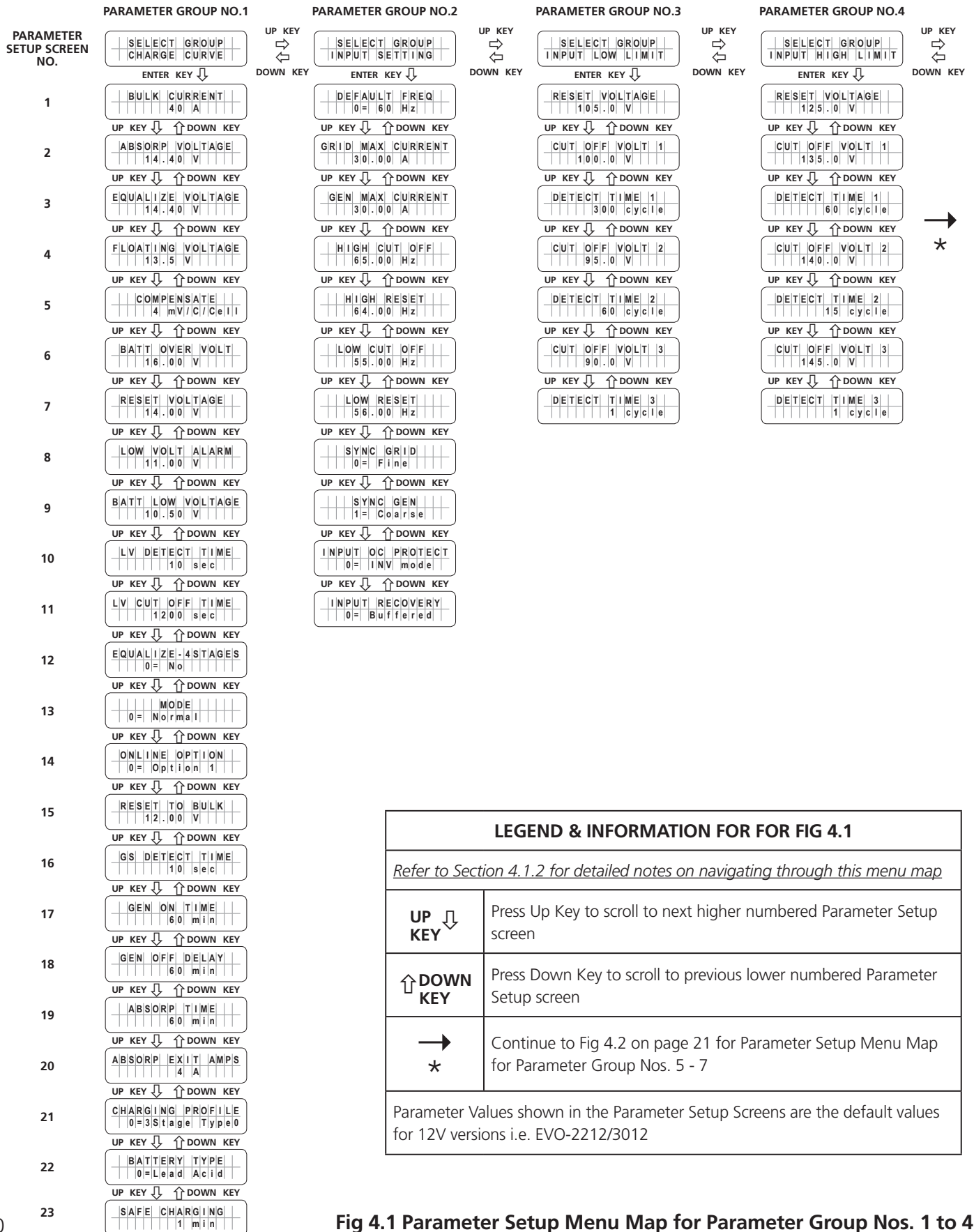
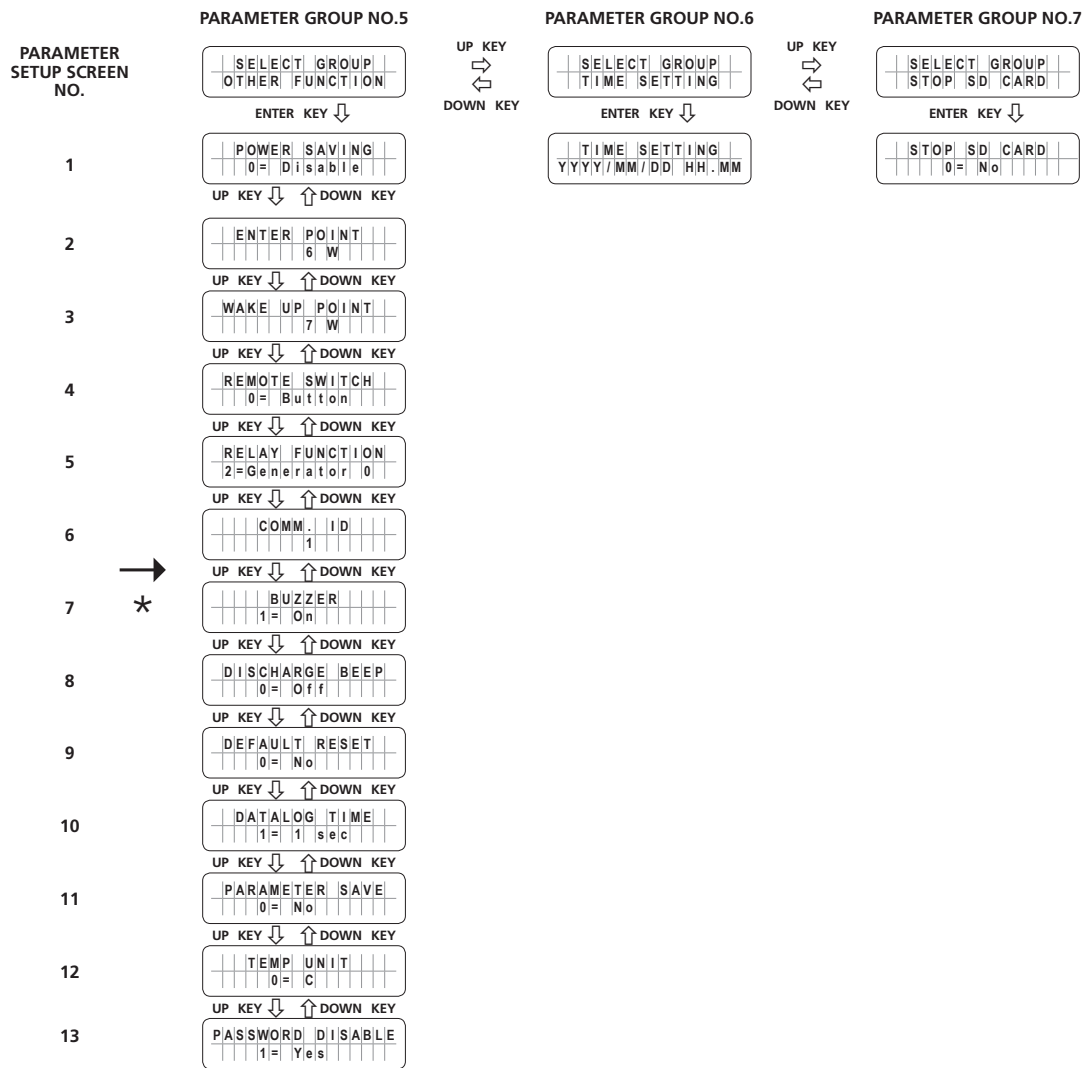

Fig 4.1 Parameter Setup Menu Map for Parameter Group Nos. 1 to 4

SECTION 4 | Parameter Setup



LEGEND & INFORMATION FOR FOR FIG 4.2	
<i>Refer to Section 4.1.2 for detailed notes on navigating through this menu map</i>	
UP KEY ↓	Press Up Key to scroll to next higher numbered Parameter Setup screen
↑ DOWN KEY	Press Down Key to scroll to previous lower numbered Parameter Setup screen
→ *	Continued from Fig 4.1 on page 20 for Parameter Setup Menu Map for Parameter Group Nos. 1 - 4
Parameter Values shown in the Parameter Setup Screens are the default values for 12V versions i.e. EVO-2212/3012	

Fig 4.2 Parameter Setup Menu Map for Parameter Group Nos. 5 to 7

4.1.2 Navigating Through Parameter Setup Menu Maps at Figs 4.1 & 4.2

- a) Values or parameters shown are the default values for the 12V versions i.e. EVO-2212/3012.
- b) For details of programmable ranges and default values of each of the parameters, please refer to Tables and names of PARAMETER GROUP NOS. and Sections given below:

Parameter Group No.	Name of Parameter Group	Table No.	Section No.
1	CHARGE CURVE	4.1	4.4
2	INPUT SETTING	4.4	4.5
3	INPUT LOW LIMIT	4.5	4.6
4	INPUT HIGH LIMIT	4.6	4.7
5	OTHER FUNCTION	4.7	4.8
6	TIME SETTING	-	4.9
7	STOP SD CARD	-	4.10

- c) Entering & navigating within Parameter Setup Menu Map (Figs 4.1 & 4.2) is explained below:

(i) Entering Parameter Setup Menu:

- Press Enter Key from any of the Operating Mode Display Screens (Figs 3.2 to 3.6) to go to PARAMETER GROUP NO.1 (CHARGE CURVE)

- Screen for PARAMETER GROUP NO.1 named "CHARGE CURVE" will be displayed:

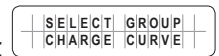

NOTE:

The 7 "PARAMETER GROUPS" in Figs 4.1 & 4.2 have the following 2 lines of display:

Line 1: Displays "SELECT PARAMETER"

Line 2: Displays the name of the PARAMETER GROUP (*Names of the 7 PARAMETER GROUPS are shown in Column 2 of Table under Section 4.1.2(b) above*)

(ii) Navigating through "PARAMETER GROUP NOS." 1 to 7:

- Press Up Key to scroll right to the next higher numbered "PARAMETER GROUP"
- Press Down Key to scroll left to the previous lower numbered "PARAMETER GROUP"
- Press Enter Key to select the desired PARAMETER GROUP NO. – PARAMETER SETUP SCREEN NO.1 of the selected "PARAMETER GROUP NO." will be displayed
- Press Back Key to go back to the previous Menu Level i.e. the Operating Mode Display Screen from where Parameter Setup Menu was accessed (Figs 3.2 to 3.6)

(iii) Navigating through PARAMETER SETUP SCREENS under the selected "PARAMETER GROUP":

- Press Up Key to scroll down to the next higher numbered PARAMETER SETUP SCREEN
- Press Down Key to scroll up to the previous lower numbered PARAMETER SETUP SCREEN
- Press Enter Key to select the desired PARAMETER SETUP SCREEN for changing parameter setting
- Press Back Key to go back to previous menu level i.e. "PARAMETER GROUP" (displayed as "SELECT GROUP")

4.2 PARAMETER SETUP PROCEDURE

4.2.1 General Information

Please refer to Fig 4.3 for general information on navigating the Parameter Setup Menu Maps at Fig 4.1 & 4.2.

4.2.1.1 Example for Setting Parameter "BULK CURRENT"

Referring to Parameter Setup Menu Maps at Figs 4.1/ 4.2, it is seen that parameter "BULK CURRENT" appears under PARAMETER GROUP NO.1 named "CHARGE CURVE" & PARAMETER SETUP SCREENS NO.1 for parameter "BULK CURRENT".

Example in Fig 4.3 below starts with Inverting Mode Screen (*Screen No.1 of 16 screens under "GROUP 2: INVERTING MODE" - Fig 3.2*). After the **Enter** key is pressed, the **Up/Down** keys are used to navigate through different "PARAMETER GROUP NOS." ("*PARAMETER GROUP NOS.*" 1-4 in Fig 4.1 & "*PARAMETER GROUP NOS.*" 5-7 in Fig 4.2). When the "PARAMETER GROUP" containing the desired parameter is displayed on the LCD (*Group 1 in Fig 4.3*), the **Enter** Key is pressed again to select this "PARAMETER GROUP". When the desired "PARAMETER GROUP NO." is selected, Screen 1 of the sub-menu screens under the selected "PARAMETER GROUP NO." appears ("*BULK CURRENT*" in example shown in Fig 4.3). The **Up** and **Down** Keys are used to navigate through the individual parameters within the selected "PARAMETER GROUP NO."

Pressing the **Back** Key will exit to the previous Menu Level.



INFO

There is a 30 second timeout for setting parameters; after 30 seconds the Setting Mode will be cancelled and the EVO-RC will revert to the Operating Mode Screen associated with current operation.

It is highly recommended to set the EVO™ Date and Time (PARAMETER GROUP NO.6) as this value is used to record data logging files. (*Refer to Section 4.9 for Date and Time set up*).

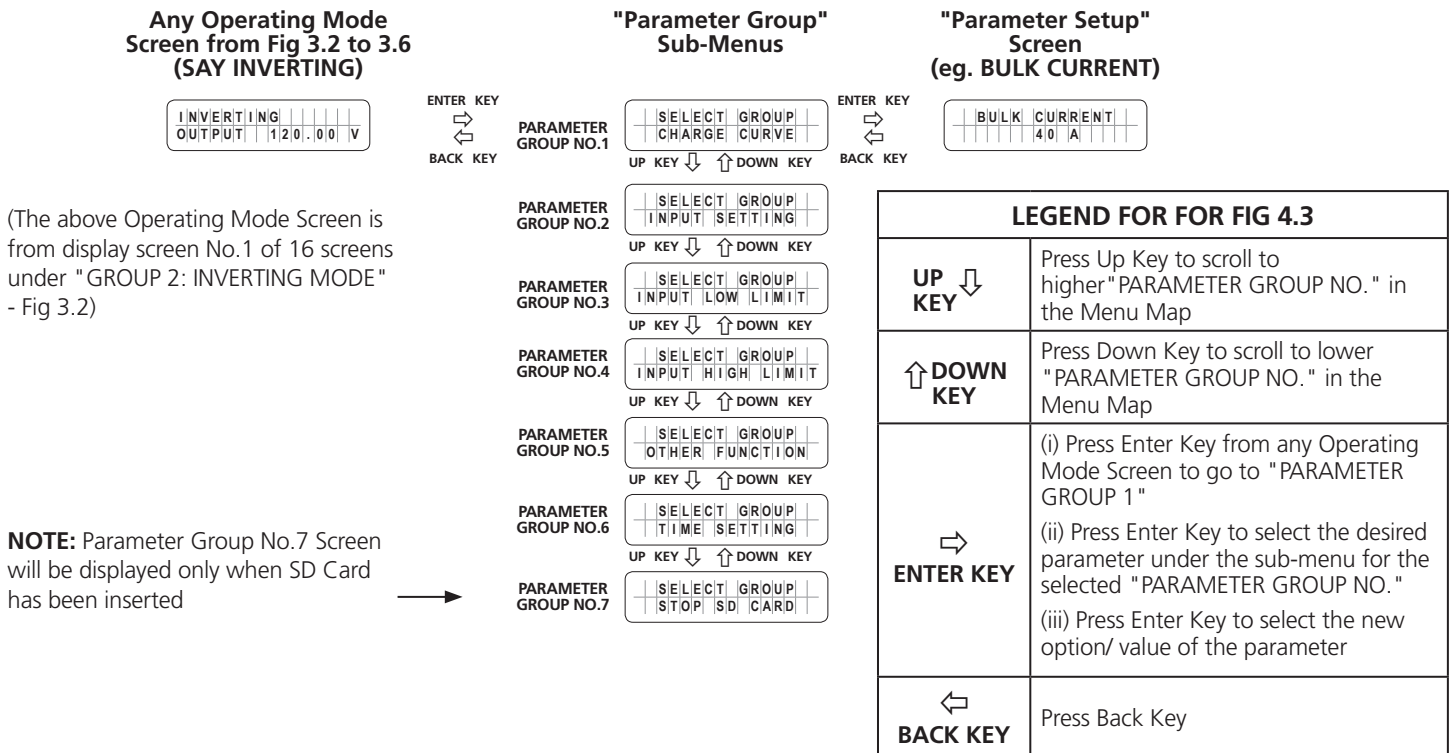

Fig 4.3 Parameter Setup Procedure – Example for Setting "BULK CURRENT"

4.2.2 Changing/ Entering Parameter Values

Each parameter has a programmable range of values specific to the model number of the EVO™. Please refer to Tables 4.1 and 4.4 to 4.7 for details. *During parameter programming*, the displayed numerical value of the parameter consists of multiple digits that are necessary to display the highest numerical value within the programmable range. For example, the programmable range for the parameter BULK CURRENT for EVO-3012 is 0-130A (Table 4.1). The highest numerical value is "130" and consists of 3 digits. Hence, for EVO-3012, the numerical value of BULK CURRENT will be displayed /entered as 3 digits. For example, 1A will be displayed / entered as "001"; 40A will be displayed / entered as "040"; 105A will be displayed / entered as "105" and so on. The overall numerical value of the parameter is changed digit by digit starting from the 1st digit on the left. On entering the selected Parameter setup screen, a cursor will appear under the 1st digit and the cursor and the digit will be blinking. Scroll to the desired numerical value for the 1st digit using Up and Down Keys. Press the Enter Key *momentarily* to write the desired numerical value for the 1st digit. The cursor will automatically move to the 2nd digit on the right. The 2nd digit and the cursor and the digit will be blinking. Scroll to the desired numerical value for the 2nd digit with the help of Up and Down Keys. Then, press the Enter Key *momentarily* to write the desired numerical value for the 2nd digit. The overall numerical value of the parameter will be selected after scrolling to the desired numerical value for the *last digit*. Now, press the Enter Key, *HOLD for 3 to 4 sec and then release*. Process for writing the overall numerical value of the parameter into the memory will be initiated – the screen will display "WRITE SUCCESS!" on completion.

Please read Section 4.3.1 for example of programming a typical parameter – BULK CURRENT



INFO

1. When the numerical value for any individual digit is changed that makes the overall numerical value of the parameter outside the programmable range, an Exclamation Sign "!" will appear on the left of the display screen warning you to correct the overall numerical value of the parameter to within the programmable range before writing the new overall numerical value of the parameter to memory.
2. If, after scrolling to the desired numerical value for the last digit, the overall numerical value of the parameter is out of the programmable range, the Exclamation Sign "!" will continue to appear on the left of the display screen. If an attempt is made to write this "out of range overall numerical value" into the memory (by *pressing and holding the Enter Key* when the cursor is at the last digit), message "OUT OF RANGE!" will be displayed and the screen will go back to display the originally stored value of the parameter. *Parameter set up procedure will have to be re-started.*
3. If there is some problem in writing to the memory, message "WRITE FAILURE!" will be displayed. *Parameter set up procedure will have to be re-started.*

4.3 PASSWORD PROTECTION FOR PARAMETER CHANGE

All parameters except Time and Date can be protected with a Password. Programmable Parameter "PASSWORD DISABLE" (See Section 4.8.2.13) is used to disable/ enable password protection. Default setting is enabled (0=No).

When the required parameter screen is reached and is displayed and Enter Key is pressed to modify the parameter value, the system will request a 4-digit Password. **The Password is 8052.** Once you **Enter** the Password correctly, you

don't need to enter the Password again until until any key is not pressed for over 60 seconds. An example of Parameter setting is shown at Section 4.3.1 below:



Password protection is considered desirable to prevent accidental/ un-intentional changes of parameter values.

4.3.1 Example of Password Activation and Changing Bulk Current Setting for EVO-2212/3012/4024 from Default Value of 40A to new value of 50A



Starting from any of the Operating Mode Screens (*shown at Fig 3.2 to 3.6*), press Enter key. Screen "SELECT GROUP, CHARGE CURVE" as shown on the left will be displayed (*PARAMETER GROUP NO.1 of Menu Map, Fig 4.1*)

Press Enter key to access up to 23 PARAMETER SETUP SCREENS under PARAMETER GROUP NO.1 "CHARGE CURVE", (*Parameters are detailed at Table 4.1 and Fig 4.1*)



Screen "BULK CURRENT, 40A" as shown on the left will be displayed (PARAMETER SETUP SCREEN NO.1 of PARAMETER GROUP NO.1 "*CHARGE CURVE*", *Fig 4.1*). Default current setting of 40A or previously set value will be displayed.

Press Enter Key to change the value of parameter BULK CURRENT.



Password - 8052

Password consisting of 4 digits will be requested as shown in the display screen on the left. 4 digits will be displayed (*with initial value 0000*) with the cursor blinking on the first digit (0) on the left (shows digit "0" and cursor " " alternately). Use Up /Down Keys to scroll to number 8 for the first digit "8" of the password. **Momentarily** press Enter Key (**Short** press). Digit 8 will be entered as the first digit of the Password and the blinking cursor will automatically move to the 2nd digit (0) to the right. As the next digit in the Password "8052" is "0", **momentarily** press Enter Key (**Short** press) to enter "0" in the second digit. The blinking cursor will automatically move to the 3rd digit (0). Use Up /Down Keys to scroll to number 5 for the 3rd digit "5" of the password "8052" and **momentarily** press Enter Key (**Short** press). The blinking cursor will automatically move to the 4th digit (0). Use Up /Down Keys to scroll to number 2 for the 4th digit "2" of the password "8052". Now keep the Enter Key **pressed continuously for longer time** (3 to 4 sec) to write the full password of 4 digits i.e. "8052".



Screen as shown on the left flashes twice when Password is correct. (8052)



Screen as shown on the left flashes twice when Password is not correct.

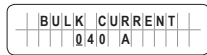

The 1st screen of parameter “BULK CURRENT” setting appears as shown on the left. For EVO-2212/3012/4024, the upper limit of the programming range of parameter “BULK CURRENT” is > 100A (see Table 4.1) and hence, 3 digits will be required to enter value of 100 A and above. Therefore, the default value of 40A will be displayed as “0 40” with alternate blinking of the 1st digit between digit “0” and cursor “_” [NOTE: For EVO-2224, the upper limit of the programming range of parameter “BULK CURRENT” is 70A (see Table 4.1) and hence, 2 digits will be required. Therefore, the default value of 40A for EVO-2224 will be displayed as 40 with alternate blinking of the 1st digit between digit “4” and cursor “_”]

To change the setting to new value of say 50A, the 3 digits will have to be changed from “040” to “050” value

- As the 1st digit of the new setting “050” is “0”, there is no need to change this value. Press the Enter Key **MOMENTARILY** to select “0” for the 1st digit. The blinking cursor will automatically move to the 2nd digit “4” with alternate blinking of digit “4” and cursor “_”
- Press the Up Key to scroll the 2nd digit to “5”. Press the Enter Key **MOMENTARILY** to select “5” for the 2nd digit. The blinking cursor will automatically move to the 3rd digit “0” with alternate blinking of digit “0” and cursor “_”
- As the 3rd digit of the new setting “050” is already “0”, there is no need to change this value. Now the overall numerical value will be “050” with alternate blinking of digit “0” and cursor “_”
- Press the Enter Key, **HOLD for 3 to 4 sec** and then release to initiate writing of the new value of 50A into the memory (See NOTE below)

NOTE: When the last digit is changed to the desired digit (“0” in this case) by using the Up / Down Keys, the Enter Key has to be pressed continuously for 3 to 4 sec till message “WRITE SUCCESS” is seen. If the Enter Key is pressed momentarily or for shorter duration (before “WRITE SUCCESS” message is seen), the value will NOT be written into the memory and the cursor will move back to the 1st digit



Screen as shown on the left flashes twice when writing is successful.

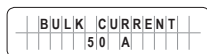

Screen as shown on the left shows end of setting.

Press Back Key to go back to the previous menu level i.e. PARAMETER GROUP NO.1 (Displayed as “SELECT GROUP CHARGE CURVE”) or Up/Down Key to any of the 23 PARAMETER SETUP SCREENS under the Sub-menu for PARAMETER GROUP NO.1 (Displayed as “SELECT GROUP CHARGE CURVE”).

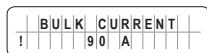

An exclamation sign ‘!’ as shown in screen on the left is displayed when the parameter is out of the specified programming range. For example, if 90A displayed was entered for EVO-2224 (EVO-2224 range is 0-70A), it will be out of range and an exclamation sign ‘!’ will be displayed.



Screen as shown on the left flashes twice when there is a write failure.

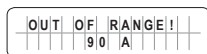

Screen as shown on the left flashes twice when the set value is out of range. (90A is out of range for EVO-2224 because EVO-2224 range is 0-70A).

All programmable parameters (See Parameter Setup Menu Maps at Figs 4.1 and 4.2) and their Default Values are described in Sections 4.4 to 4.10.

4.4 PROGRAMMING INFORMATION FOR PARAMETER GROUP NO.1 – CHARGE CURVE

4.4.1 Programming Ranges & Default Values of Parameters Under Parameter Group No.1 - Charge Curve

Table 4.1 below gives details of programming ranges and default values of parameters under Parameter Group No.1 - "CHARGE CURVE". Refer to the Menu Map in Fig 4.1 ([Section 4.1](#)) for navigating through various parameters under this Parameter Group No.1.

TABLE 4.1 PROGRAMMING INFORMATION FOR PARAMETER GROUP NO.1 – CHARGE CURVE									
Parameter Setup Screen No. for Parameter Group No.1 <i>(Fig 4.1)</i>	Parameter	Programming Range				Default			
		EVO-2212	EVO-3012	EVO-2224	EVO-4024	EVO-2212	EVO-3012	EVO-2224	EVO-4024
1	"BULK CURRENT" (<i>See NOTE 1</i>) (Bulk Charge Current "I _o ")	0-100A	0-130A	0-70A	0-110A	40A			
2	"ABSORP VOLTAGE" (Absorption Voltage)	12.00V - 16.00V		24.00V - 32.00V		14.40V		28.80V	
3	"EQUALIZE VOLTAGE" (Equalization Voltage)	14.00V - 16.50V		28.00V - 33.00V		14.40V		28.80V	
4	"FLOATING VOLTAGE" (Float Voltage)	12.00V - 15.00V		24.00V - 30.00V		13.50V		27.00V	
5	"COMPENSATE" (Temperature Compensation)	3mV to 5mV /C/Cell				4mV /C/Cell			
6	"BATT OVER VOLT" (Battery Over Voltage Shutdown)	14.00V - 17.00V		28.00V - 35.00V		16.00V		32.00V	
7	"RESET VOLTAGE" (Reset voltage for "BATT LOW VOLTAGE" condition)	12.00V - 17.00V		28.00V - 35.00V		14.00V		28.00V	
8	"LOW VOLT ALARM" (Battery Low Voltage Alarm)	9.50V to 13.50V		19.00V to 27.00V		11.00V		22.00V	
9	"BATT LOW VOLTAGE" (Battery Low Voltage Shutdown)	>9.00V to 13.00V		>18.00V to 26.00V		10.50V		21.00V	
10	"LV DETECT TIME" (Time to qualify "BATT LOW VOLTAGE" condition)	0 - 600 sec				10 sec			
11	"LV CUT OFF TIME" (Time in "BATT LOW VOLTAGE" condition to trigger complete shutdown)	0 - 7200 sec				1200 sec			
12	"EQUALIZE-4STAGES" (4 Stage Adaptive Equalization On/ Off)	0 = No (3-Stage / 2-Stage) 1 = Yes (4-Stage Equalization)				0 = No (3-Stage / 2-Stage)			

13	"MODE"	0 = Normal.....Grid/Gen priority <i>(Also called Off-Line Mode)</i> 1 = On-Line.....Inverter priority <i>(Also called On-Line Mode)</i> 2 = Charger Only...Charging & AC bypass only, no inverting	0 = Normal
14	"ONLINE OPTION"	0 = Option 1 1 = Option 2	0 = Option 1
15	"RESET TO BULK"	10.00V to 13.00V 20.00V to 26.00V	12.00V 24.00V
16	"GS DETECT TIME"	0 - 600 sec	10 sec
17	"GEN ON TIME"	0 - 240 min	60 min
18	"GEN OFF DELAY"	0 - 240 min	60 min
19	"ABSORP TIME"	0 - 600 min	60 min
20	"ABSORP EXIT AMPS"	0 - 20A	4A
21	"CHARGING PROFILE"	0 = 3 Stage Adaptive 1 = 3 Stage Type 1 2 = 3 Stage Type 2 3 = 2 Stage Type 1 4 = 2 Stage Type 2 5 = 2 Stage Type 3	0 = 3 Stage Adaptive
22	"BATTERY TYPE"	0 = Lead Acid 1 = Lithium	0 = Lead Acid
23	"SAFE CHARGING"	0 - 300 min	0 min

NOTE 1:

"BULK CURRENT" value may automatically reduce in higher ambient temperatures of around 50° - 60°C if Power Transformer temperature exceeds 130°C or Heat Sink temperature exceeds 65°C. See ⓘ INFO under Section 4.4.2.1 for details

4.4.2 Description of Parameters Under Parameter Group No.1, "CHARGE CURVE"

4.4.2.1 BULK CURRENT *(Table 4.1, Parameter Setup Screen No.1)*

Parameter "BULK CURRENT" sets the maximum charging current during the Bulk Charging Stage. The default value is 40A.

Normally, Lead Acid batteries should not be charged at very high value of BULK CURRENT as this may damage the batteries due to overheating and cell degradation. Normal BULK CURRENT for Lead Acid Batteries is in the range of 10% to 20% of the Ah capacity of the battery bank at C/20 Discharge Rate. *Lithium Ion Batteries can be charged at much higher Bulk Current as compared to Lead Acid type.* Check with the battery manufacturer regarding recommended BULK CURRENT for your battery bank.

i INFO

1. Automatic Reduction of "BULK CURRENT" Setting when Operating in Higher Ambient Temperature

In order to protect against over temperature shut down when operating in higher ambient temperatures, the set value of "BULK CURRENT" is automatically reduced as follows based on temperature sensed at the Power Transformer and at the Heat Sink for the Power Mosfets:

- *Power Transformer Temperature > 130°C*: (i) EVO-2212: Reduce by 4A every 10 sec, (ii) EVO-3012: Reduce by 20A every 10 sec, (iii) EVO-2224: Reduce by 1A every 10 sec, (iv) EVO-4024: Reduce by 5A every 10 sec.
- *Heat Sink Temperature is > 65°C*: (i) EVO-2212: Reduce by 4A every 10 sec, (ii) EVO-3012: Reduce by 20A every 10 sec, (iii) EVO-2224: Reduce by 1A every 10 sec, (iv) EVO-4024: Reduce by 5A every 10 sec.

2. Automatic Adjustment of "BULK CURRENT" Setting when External Solar Charge Controller is also Charging

In case external Solar Charge Controller is also charging the batteries through DC input terminals marked "EXT Charger", the amount of Bulk Charging Current produced by the internal Battery Charging Section is adjusted in real time to satisfy the following condition:

- Internal Bulk Charging Current = Programmed Value of "BULK CURRENT" – External Charging Current
- For example, if the "BULK CURRENT" in the EVO-2212 is programmed at say the default value of 40A and the external Solar Charge Controller is generating 15A, the internal Battery Charging Section of EVO-2212 will reduce its current from 40A to 25A so that the net charging current is equal to the programmed "BULK CURRENT" value of 40A

4.4.2.1.1 Programming Steps for Parameter "BULK CURRENT"

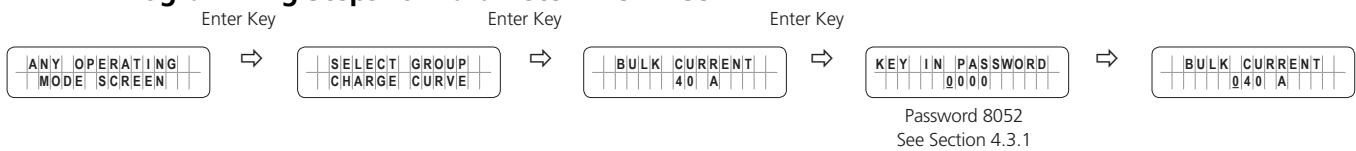

4.4.2.2 ABSORP VOLTAGE (Table 4.1, Parameter Setup Screen No.2)

This sets the charging voltage in the Constant Voltage Absorption Stage.

4.4.2.1.1 Programming Steps for Parameter "BULK CURRENT"

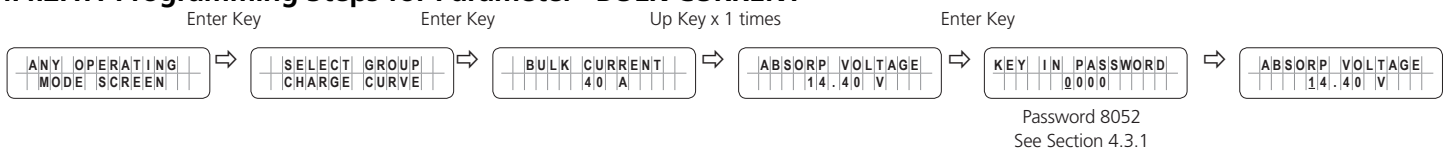

4.4.2.3 EQUALIZE VOLTAGE (Table 4.1, Parameter Setup Screen No.3)

This sets the charging voltage in the Constant Voltage Equalization Stage in the 4-stage Adaptive Charging Profile for Equalization.

4.4.2.3.1 Programming Steps for Parameter "EQUALIZE VOLTAGE"

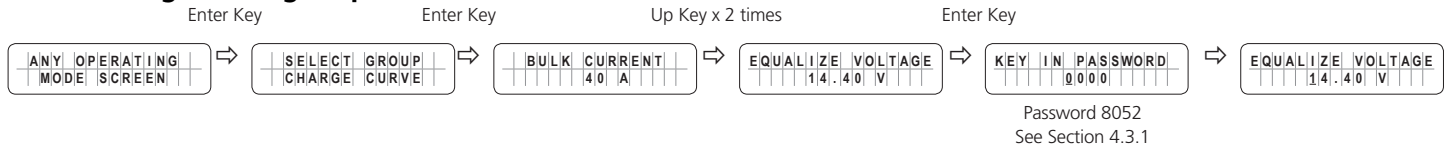

4.4.2.4 FLOATING VOLTAGE (Table 4.1, Parameter Setup Screen No.4)

This sets the charging voltage in the Constant Voltage Float Stage.

4.4.2.4.1 Programming Steps for Parameter "FLOATING VOLTAGE"

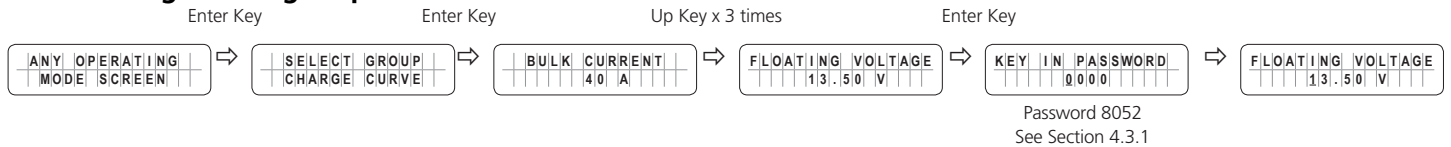

4.4.2.5 COMPENSATE (Table 4.1, Parameter Setup Screen No.5)

This parameter sets the temperature compensation for the battery. The operating range of the EVO™ Inverter/Charger is -20°C to 60°C.

This compensation voltage will affect the Absorb Voltage/Equalize Voltage/Floating Voltage/Batt Over Volt/Restart Voltage/Low Volt Alarm/Batt Low Voltage when the Temperature Sensor is installed on the battery (see Fig 2.5 in the Owner's Manual for Evolution™ Series Inverter/Charger).



CAUTIONS!

1. Lithium Ion charging does not require temperature compensation. Hence, do not use EVO-BCTS Temperature Sensor when charging Lithium Ion Batteries.
2. Automatic temperature compensation using EVO-BCTS Temperature Sensor is designed for Lead Acid Batteries based on programming parameter "COMPENSATE". When charging Nickel-Zinc (Ni-Zn) batteries, ensure that the value of programming parameter "COMPENSATE" is set based on approximate linear compensation for the particular Ni-Zn battery.



ATTENTIONS!

1. Le chargement au lithium-ion ne nécessite pas de compensation de température. Par conséquent, n'utilisez pas le capteur de température EVO-BCTS lors du chargement de batteries au lithium-ion.
2. Compensation automatique de la température à l'aide d'EVO-BCTS Capteur de température est conçu pour les batteries au plomb basée sur la programmation paramètre "COMPENSATE". Lorsque la charge des batteries Nickel-Zinc (Ni - Zn), s'assurer que la valeur du paramètre de programmation "COMPENSATE" est déterminé en fonction du linéaire approximatif pour l'indemnisation de la batterie Ni - Zn particulier.

4.4.2.5.1 Programming Steps for Parameter "COMPENSATE"

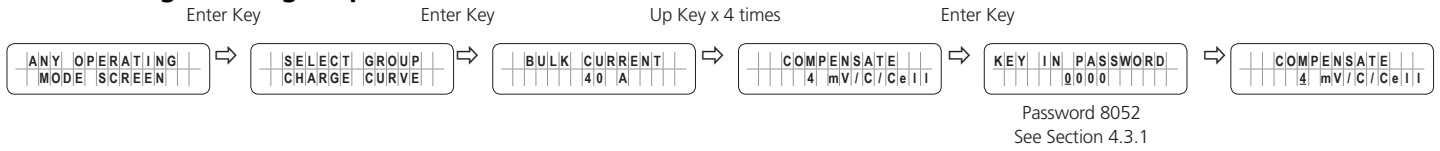

4.4.2.6 BATT OVER VOLT (Table 4.1, Parameter Setup Screen No.6)

This parameter sets the upper battery voltage threshold at which inverting / charging operations are switched OFF to protect the unit against damage due to battery overvoltage:

- AC input is not available and EVO™ Inverter/Charger is operating in Inverting Mode:** When the battery voltage rises to the set upper threshold of "BATT OVER VOLT", the Inverter Section will be shut down and fault message "Battery over voltage!" will be displayed on the LCD screen. The Green LED marked "Status" will switch OFF and the Red LED marked "Fault" will remain ON steady. The buzzer on EVO™ Inverter/Charger will beep steady. The fault will be cleared automatically when the battery voltage drops to 0.5V below the set upper threshold of "BATT OVER VOLT"
- AC input is available and EVO™ Inverter/Charger is operating in Charging Mode:** When the battery voltage rises to the set upper threshold of "BATT OVER VOLT", the Transfer Relay will be de-energized, charging and pass through will be stopped and PWM drive to the Inverter Section will be switched OFF. Fault message "Battery over voltage!" will be displayed on the LCD screen. The Green LED marked "Status" will switch OFF and the Red LED marked "Fault" will remain ON steady. The Buzzer on EVO™ Inverter/Charger will beep steady. The fault will be cleared automatically when the battery voltage drops to 0.5V below to the set upper threshold of "BATT OVER VOLT". The unit will start in Inverting Mode, synchronize with the AC input and then, the Transfer Relay will be energized to transfer to AC input at zero crossing. The unit will, thus, resume operation in "Charging Mode".

4.4.2.6.1 Programming Steps for Parameter "BATTERY OVER VOLT"

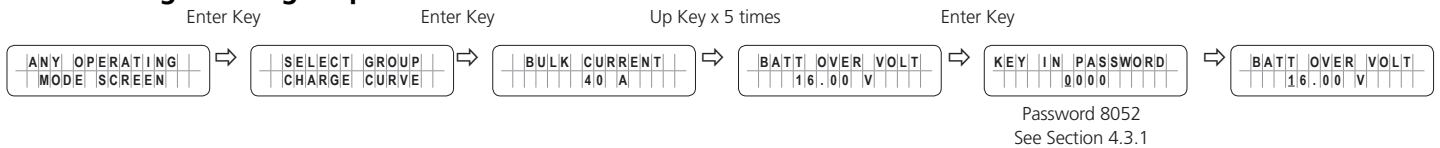

4.4.2.7 RESET VOLTAGE (Table 4.1, Parameter Setup Screen No.7)

The inverter will restart when the battery voltage rises above this set value after "Battery low voltage!" shutdown occurs (Table 7.1, Srl No.1). If Relay Function is set for "3 = Generator 1", the relay will turn OFF (See Section 4.8.2.5.2.2).

4.4.2.7.1 Programming Steps for Parameter "RESET VOLTAGE"

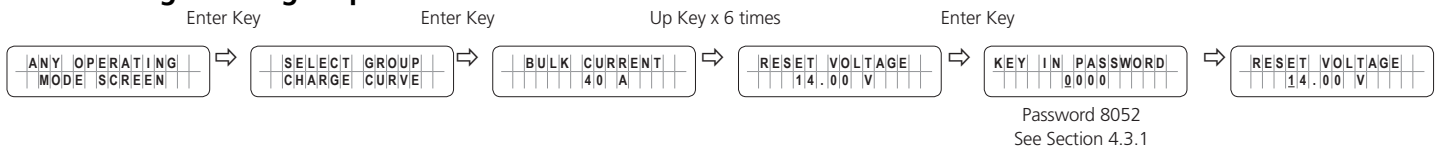

4.4.2.8 LOW VOLT ALARM (Table 4.1, Parameter Setup Screen No.8)

When inverting, if battery voltage is under the set value of this parameter, the Red LED marked "Fault" flashes once per second. The buzzer in EVO™ Inverter/Charger will beep once per second. If Relay Function is set for Generator, the relay will turn ON (See Section 4.8.2.5.2). If in On-Line Mode, it will transfer from Inverting Mode to Charging Mode (See Section 4.4.2.13.2).

4.4.2.8.1 Programming Steps for Parameter "LOW VOLT ALARM"

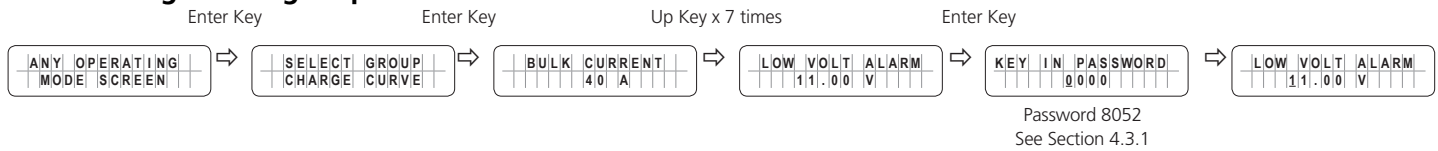

4.4.2.9 BATT LOW VOLTAGE *(Table 4.1, Parameter Setup Screen No.9)*

This parameter sets the battery low voltage threshold at which suitable protection is initiated to prevent deep discharge of the battery. The protections are detailed in Sections 4.4.2.9.1 & 4.4.2.9.2 below:

4.4.2.9.1 BATTERY LOW VOLTAGE *[Value of parameter LV CUT OFF TIME (Section 4.4.2.11) set from 1 to 7200 Sec]*

- When the battery voltage drops to the set threshold of "BATT LOW VOLTAGE", the Red LED marked "Fault" will blink once at intervals of 1 sec. The buzzer in EVO™ Inverter/Charger will beep once at intervals of 1 sec. The Inverter Section will continue to operate normally and the Green LED marked "Status" will continue to be ON steady.
- If the battery voltage stays at or below the above threshold for duration equal to the "LV DETECT TIME" *(Section 4.4.2.10)*, only the Inverter Section will be switched OFF and fault message "Battery low voltage!" *(Section 7, Table 7.1, Srl.1)* will be displayed. The Green LED marked "Status" will be switched OFF and the Red LED marked "Fault" will remain ON steady. The buzzer in EVO™ Inverter/Charger will beep steady.
- If the batteries are charged by external Solar Charge Controller connected directly to the batteries or through the External Charger Input *(3, 4 in Fig 2.1 in the attached Owner's Manual for EVO-2212/3012/2224/4024)* and the battery voltage recovers to the set "RESET VOLTAGE" *(Section 4.4.2.7)* before the expiry of "LV CUT OFF TIME" *(Section 4.4.2.11)* while in "Battery low voltage!" fault condition, the Inverter Section will restart and the "Battery low voltage!" fault condition will be cleared.
- While in "Battery low voltage!" fault condition *(Section 7, Table 7.1, Srl.1)*, if AC input is made available before the expiry of "LV CUT OFF TIME" *(Section 4.4.2.11)*, the "Battery low voltage!" fault condition will be cleared. The EVO™ Inverter/Charger will restart in Inverter Mode, synchronize with the AC input and then, transfer to the AC input at zero crossing. It will now operate in Charging Mode.
- If the "Battery low voltage!" fault condition is **NOT** reset within the "LV CUT OFF TIME" *(Section 4.4.2.11)*, the EVO™ Inverter/Charger will be shut down completely after the programmed value of LV CUT OFF TIME has elapsed. *The LCD display/ Status LED/ Buzzer will be off in this condition.*

4.4.2.9.2 BATT LOW VOLTAGE *[Value of parameter LV CUT OFF TIME (Section 4.4.2.11) set at 0 Sec]*

When programming value of parameter "LV CUT OFF TIME" *(Section 4.4.2.11)* is set at 0 sec, "Battery low voltage!" fault condition *(Section 7, Srl. 1 of Table 7.1)* will operate as follows:

- The unit will NOT shut down completely due to "Battery low voltage!" fault condition *(as in Section 4.4.2.9.1)* but will continue to display fault message "Battery low voltage!" *(Section 7, Srl. 1 of Table 7.1)* after expiry of "LV DETECT TIME" *(Section 4.4.2.10)*.
 - Green LED marked "Status" *[3 in Fig 1.1(a)]* will be switched off
 - Red LED marked "Fault /Alarm" *[4 in Fig 1.1(a)]* will be ON steady
 - Buzzer in the EVO Inverter Charger will beep once at intervals of 1 sec

- b1) The unit will automatically switch to "Charging Mode" only under the following conditions:
- If qualified AC input is available that is within the limits of voltage ([Sections 4.6 and 4.7](#)) and frequency ([Sections 4.5.2.4 and 4.5.2.6](#))
 - If the battery voltage at the time of qualified AC input availability is higher than "Battery ultra low voltage!" fault threshold of 9V for EVO-2212 / 3012 or 18V for EVO-2224 / 4024 ([Section 7, Srl. 2 of Table 7.1](#)).
- b2) Automatic switching over to "Charging Mode" has 2 options selectable through programming parameter "INPUT RECOVERY" ([Section 4.5.2.11](#)) as follows:
- Option 0=Buffered (Default):** Under this option, the unit will initially start in "Inverting Mode", synchronize with the AC input and then transfer to "Charging Mode". However, if a user programs the value of "BATTERY LOW VOLTAGE" ([Section 4.4.2.9](#)) very close to the "Battery ultra low voltage!" fault threshold of 9V for EVO-2212 / 3012 or 18V for EVO-2224 / 4024 ([Section 7, Srl. 2 of Table 7.1](#)), a larger load / larger starting surge of the load may drag the battery voltage to 9V / 18V or below for 1 ms and trigger "Battery ultra low voltage!" fault ([Section 7, Srl. 2 of Table 7.1](#)). Under this condition, the user may change to **Option 1=Direct**
 - Option 1=Direct:** Under this option, the unit will directly start in "Charging Mode"

4.4.2.9.3 Programming Steps for Parameter "BATT LOW VOLTAGE"

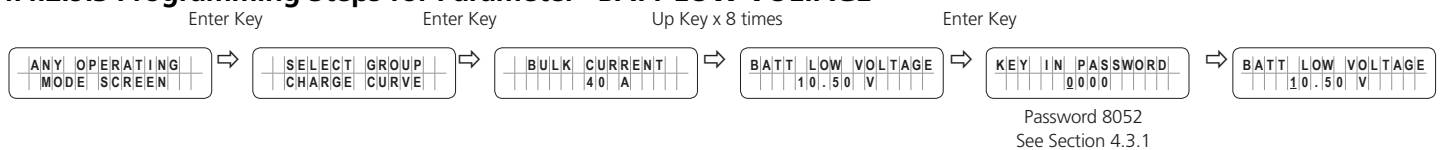

4.4.2.10 LV DETECT TIME (Table 4.1, Parameter Setup Screen No.10)

To prevent "Battery low voltage!" fault and shut down of the inverter due to momentary dips in battery voltage as a result of high power, short duration AC loading (e.g. motor starting, inrush current etc.), a timer is used to qualify "BATT LOW VOLTAGE" condition only if the battery voltage drops to or below the set "BATT LOW VOLTAGE" threshold for the set "LV DETECT TIME". The timer starts as soon as the battery voltage drops to the set threshold of "BATT LOW VOLTAGE" described at Section 4.4.2.9.

4.4.2.10.1 Programming Steps for Parameter "LV DETECT TIME"

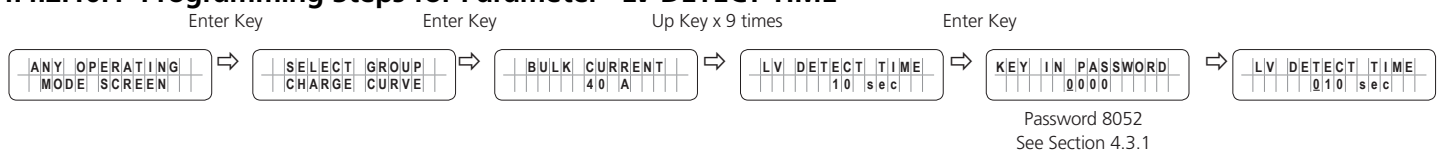

4.4.2.11 LV CUT OFF TIME (Table 4.1, Parameter Setup Screen No.11)

4.4.2.11.1 Value of "LV CUT OFF TIME": 1 to 7200 sec

Even when the Inverter Section is shut down due to "Battery low voltage!" fault condition as described at Section 4.4.2.9, there will still be some power drawn from the battery to keep the other circuitry in the EVO™ Inverter/Charger alive so that the inverter can be switched on when the fault gets cleared automatically after the battery has been recharged to the "RESET VOLTAGE" ([Section 4.4.2.7](#)) or when AC input voltage is available. However, if the fault is not cleared over a long period of time, the battery may get completely discharged. Hence, a timer is used to record the duration of "Battery low voltage!" condition. The EVO™ Inverter/Charger will be completely shut down ([LCD Display / LED / Buzzer will be OFF](#)) when the duration of the "Battery low voltage!" fault condition as described above is equal to the "LV CUT OFF TIME".

4.4.2.11.2 Value of "LV CUT OFF TIME": 0 sec

4.4.2.11.2.1 When the value of parameter "LV CUT OFF TIME" is set at 0 sec, activation and resetting of Battery low voltage! " fault condition (*Section 7, Srl.1 of Table 7.1*) will be as described in Section 4.4.2.9.2.

4.4.2.11.3 Programming Steps for Parameter "LV CUT OFF TIME"

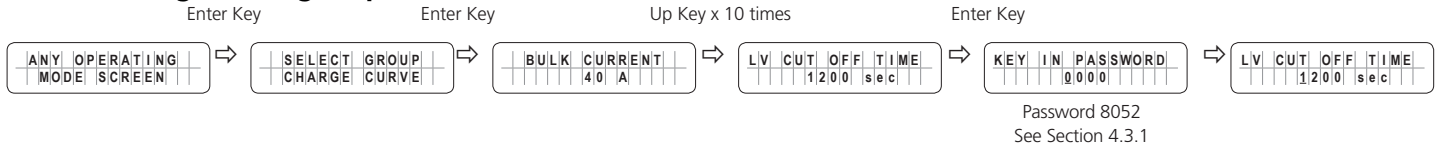



4.4.2.12 EQUALIZE – 4 STAGES (*Table 4.1, Parameter Setup Screen No. 12*)

Please refer to Section 5.8.2 of EVO-2212/3012/2224/4024 Manual for background information on 4-Stage Adaptive Charging Profile for Equalization

When AC input within the programmed window of voltage and frequency is available, EVO will operate as a battery charger and charging will be carried out based on the selected option of parameter "CHARGING PROFILE". Parameter "CHARGING PROFILE" (*Section 4.4.2.21*) allows option to select from 6 Charging Profiles - 3 profiles of 3-Stage and 3 profiles of 2-Stage charging. Default profile option is "0=3 Stage Adaptive"

4-Stage Adaptive Charging Profile for Equalization can be activated AT ANY TIME through programmable parameter "EQUALIZE-4STAGES" set to "1=Yes". The Default Setting is "0=No" i.e. charging will be carried out as per 3 or 2-Stage profile that has been selected by parameter "CHARGING PROFILE" (*Section 4.4.2.21*). After the 4-Stage Adaptive Charging Profile for Equalization is completed, parameter "EQUALIZE-4STAGES" resets automatically to the default setting i.e. Option "0=No" and the charging profile reverts to the last stage of the "CHARGING PROFILE" that was active when 4-Stage Adaptive Charging Profile for Equalization was activated. Details are given at Table 4.2 below:

TABLE 4.2 CHARGING PROFILE FOR 4-STAGE ADAPTIVE CHARGING FOR EQUALIZATION

Srl No.	Options under Programming Parameter "EQUALIZE-4 STAGES"	Charging Stages	Battery Type
1	<p>EQUALIZE – 4 STAGES</p> <p>0 = No (Default Setting) 1 = Yes</p>	<p>1. Stage 1 – Bulk Stage (<i>See Section 5.8.2 of the attached EVO-2212/3012/2224/4024 Owner's Manual for details:</i>)</p> <ul style="list-style-type: none"> Charge at constant current (CC) = the programmed value of parameter "BULK CURRENT" (Default value is 40A. <i>For details of programming range & procedure, refer to Section 4.4.2.1</i>) Transition to Absorption Stage when voltage rises to the set value for programming parameter "ABSORP VOLTAGE" (Default value is 14.4V for EVO-2212/3012 and 28.8V for EVO-2224/4024. <i>For details of programming range & procedure, refer to Section 4.4.2.2</i>) <p>2. Stage 2 - Absorption Stage (<i>See Section 5.8.2 of the attached EVO-2212/3012/2224/4024 Owner's Manual for details:</i>)</p> <ul style="list-style-type: none"> Charge at constant voltage (CV) = the programmed value for parameter "ABSORP VOLTAGE". (Default value is 14.4V for EVO-2212/3012 and 28.8V for EVO-2224/4024. <i>For details of programming range & procedure, refer to Section 4.4.2.2</i>) Adaptive Time Algorithm: Time in Absorption Stage is computed automatically based on time in Bulk Stage (<i>See Section 5.8.2 of the attached EVO-2212/3012/2224/4024 Owner's Manual for details</i>) Transition to Equalization Stage thereafter. <p>3. Stage 3 - Equalization Stage (<i>Section 5.8.2 of the attached EVO-2212/3012/2224/4024 Owner's Manual for details:</i>)</p> <ul style="list-style-type: none"> Charge at constant voltage (CV) = the programmed value of parameter "EQUALIZE VOLTAGE". (Default value is 14.4V for EVO-2212/3012 and 28.8V for EVO-2224/4024. <i>For details of programming range & procedure, refer to Section 4.4.2.3</i>) Adaptive Time Algorithm: Time in Equalization Stage is computed automatically based on time in Bulk Stage. (<i>See Section 5.8.2 of the attached EVO-2212/3012/2224/4024 Owner's Manual for details</i>) Transition to Float Stage thereafter. <p>4. Stage 4 - This stage will be the same as the last Stage of Charging Profile from where Equalization was started. (<i>For details, refer to Table 5.2.1 under Section 5.8.2.4 of the attached EVO-2212/3012/2224/4024 Owner's Manual</i>)</p>	<p>– Lead Acid: Flooded only</p> <p> CAUTIONS!</p> <ol style="list-style-type: none"> Equalize Flooded Lead Acid Batteries only. Sealed AGM / Gel Cell types of batteries are NOT equalized <i>Refer to Section 5.8.2 and Fig 5.2 of the attached Manual for EVO-2212/3012/2224/4024.</i> The Adaptive Charging Algorithm measures the Bulk Stage Time (T0) to automatically compute Absorption Stage Time (T1') and Equalization Stage Time (T2). This algorithm is fully effective only when there are no other external DC loads being supplied by the battery that may divert full or part of the BULK CURRENT resulting in undesired increase in Bulk Stage Time "(T0)" and consequently, undesired increase of Absorption Stage Time (T1') and Equalization Stage Time (T2). <i>Hence, disconnect all other external DC loads on the battery during the equalization cycle.</i> <p> ATTENTIONS!</p> <ol style="list-style-type: none"> Égaliser les batteries au plomb inondées seulement. Les batteries scellées de type AGM / cellules au gel ne sont pas égalisées. <i>Se reporter à la section 5.8.2 et figure 5.2 du manuel ci-joint pour EVO-2212/3012/2224/4024.</i> L'algorithme de charge adaptative l'essentiel des mesures de phase (T0) pour calculer automatiquement l'étape d'Absorption Temps (T1') et de la péréquation, le temps (T2). Cet algorithme n'est pleinement efficace que lorsqu'il n'y a pas d'autres charges c.c. externe alimenté par la batterie qui peut détourner tout ou partie de l'ACTUEL EN VRAC résultant en une augmentation indésirable en vrac temps Étape "(T0)" et par conséquent, augmentation indésirable de l'étape d'Absorption Temps (T1') et de la péréquation le temps (T2). <i>Par conséquent, déconnectez toutes les autres charges CC externes sur la batterie pendant le cycle d'égalisation.</i>

4.4.2.12.1 Programming Steps for Parameter "EQUALIZE-4STAGES"

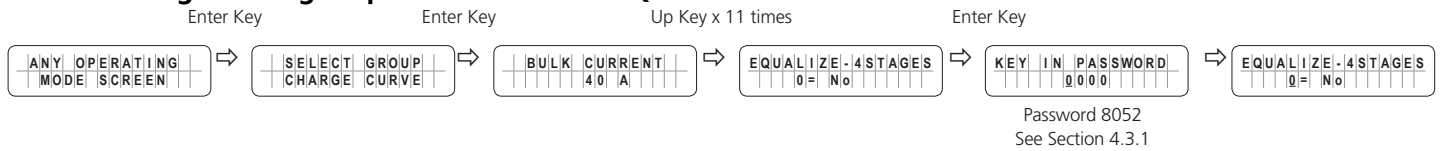

4.4.2.13 MODE (Table 4.1, Parameter Setup Screen No. 13)

Under Menu Item "MODE", the following 3 options are available:

- i. **Option: "0=Normal"** (Default). Also called Off-Line Mode. *See details at Section 4.4.2.13.1 below*
- ii. **Option: "1=On-Line"**. *See details at Section 4.4.2.13.2 below*
- iii. **Option: "2=Charger Only"**. *See Section 4.4.2.13.3 below*

4.4.2.13.1 Option: "0=Normal" (Default)

This option is also called "Off-Line UPS Mode" (*UPS stands for Un-interruptible Power Supply*). In this mode, AC input from the Grid is the PRIMARY source of AC power and the batteries / Inverter Section of EVO is the BACK-UP source of DC-AC power. If qualified Grid AC input (*within the programmed voltage and frequency limits*) is available, the EVO will operate in "Charging Mode" and qualified Grid AC input will be passed through to the AC output and at the same time, the Internal AC Charger will start charging the batteries. If an external Solar Charge Controller is also connected to the External Charging Terminals (3, 4 in Fig 2.1 of Owner's Manual for EVO-2212/3012/2224/4024), the internal AC Charger of EVO will limit the charging current as follows:

$$\begin{aligned} &\text{Value of charging current produced by EVO} \\ &\text{Charging Section} \\ &= \\ &\text{(Programmed value of charging current set by} \\ &\text{parameter "BULK CURRENT" (Section 4.4.2.1)} \\ &\text{minus (Value of current fed from the external solar} \\ &\text{charge controller)} \end{aligned}$$

When Grid AC input fails or, is not within the programmed values of voltage and frequency, the unit will change over to "Inverting Mode" and the AC Output will be fed from the internal Inverter Section of EVO. When the Grid AC input is restored, the EVO will revert back to "Charging Mode" to charge the batteries and at the same time, pass through the Grid AC input to the AC output.

For various display screens under this mode, refer to Fig 3.2

4.4.2.13.2 Option: "1= On-Line"

This option is also called "On-Line UPS Mode" (*UPS stands for Un-interruptible Power Supply*). In this mode, the Inverter Section of the EVO is the PRIMARY DC-AC source of power. The Grid AC input is the BACK-UP source of AC power. In this mode, even if qualified Grid AC input is available (*within the programmed voltage and frequency limits*), the EVO will still operate in "Inverting Mode" and AC output will be provided by the Inverter Section as long as the batteries are in charged condition above the specified programmed value of battery voltage that is set through programmable parameter "LOW VOLT ALARM" – *See Section 4.4.2.8*. When the battery discharges to the programmed voltage threshold of "LOW VOLT ALARM", or lower and remains at this threshold, or below for a sustained programmed time period set by programmable parameter "GS DETECT TIME" (*0-600 sec; Default 10 sec – See Section 4.4.2.16*), the EVO will change over to "Charging Mode". On changing over to "Charging Mode", qualified AC input will be passed through to the AC Output and at the same time, the Internal AC Charger will start charging the battery. If an external

SECTION 4 | Parameter Setup

Solar Charge Controller is also connected to the External Charging Terminals (3, 4 in Fig 2.1 of Owner’s Manual for EVO-2212/3012/2224/4024), the internal AC Charger will limit the charging current as follows:

$$\begin{matrix} \text{Value of charging current produced by EVO} \\ \text{Charging Section} \end{matrix} = \begin{matrix} \text{(Programmed value of charging current set by} \\ \text{parameter "BULK CURRENT" (Section 4.4.2.1)} \\ \text{minus (Value of current fed from the external solar} \\ \text{charge controller)} \end{matrix}$$

Under the following conditions, "Charging Mode" will be terminated, and the EVO will switch back to "Inverting Mode" (*Switching from "Charging Mode" back to "Inverting Mode" has 2 options under programming parameter "ONLINE OPTION" - see Section 4.4.2.14 for details*):

- i. When the batteries have been re-charged either fully through complete, 3-Stage Charging algorithm (*Parameter "ONLINE OPTION" set at "0= Option 1" - See Section 4.4.2.14*) **or**,
- ii. When the batteries have been recharged for a sustained programmed time period set by programmable parameter "GEN OFF DELAY" (*0-240 min; Default 60 min" – See Section 4.4.2.17*). [*Parameter "ONLINE OPTION" set at "1= Option 2" - See Section 4.4.2.14*].

i INFO

On-Line Mode is suitable for installations where both Grid and Photovoltaic (PV) Solar Battery Charging System are available. It is also desirable in areas where Grid / Utility Energy Rates are very high and use of supplementary battery based photovoltaic power system is more cost effective.

For various display screens under this mode, refer to Fig 3.3(a) to (d)

4.4.2.13.3 Option: "2=Charger Only".

In Off-grid DC powered homes, for efficiency consideration, all lighting and other loads / appliances are normally powered from batteries that are primarily charged through solar / wind power. Generator backup is used for powering AC to DC battery charger for charging the batteries during extended periods of cloudy / no wind conditions. To meet this requirement, the EVO™ can be programmed *to operate as a battery charger ONLY* i.e. when AC input power is available within the programmed limits of voltage and frequency, charging will take place and AC input will be passed through to the load(s). The unit will NOT transfer to Inverting Mode if AC input fails or is outside the programmed limits of voltage and frequency. (*Refer to Section 3.8 regarding Menu Map for operating Mode Screens during this mode*)

- 19 scrollable Operating Mode Screens for Charging Mode will be displayed (*See under Column 4 – "GROUP 3: CHARGING MODE" in Fig 3.2*). Extract of Screen No.1 is shown below as an example.



As mentioned above, when the AC input fails, the Inverter Section will NOT be activated, and the AC side loads will lose AC power. EVO will operate in Standby Mode as long as AC input power is NOT available.

- Operating Mode Screens for Standby Mode will be displayed (*See 7 scrollable Screens under Column 2 – "GROUP 1: STANDBY MODE" in Fig 3.2*). Extract of Screen 1 is shown below as an example:

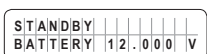

If attempt is made to exit Standby Mode by momentarily pressing the On/Off Key, the following message will be seen for some time and the screen will revert back to Standby Mode Screen



For various display screens under this mode, refer to Figs 3.4(a) & 3.4(b)

4.4.2.13.4 Programming Steps for Parameter "MODE"

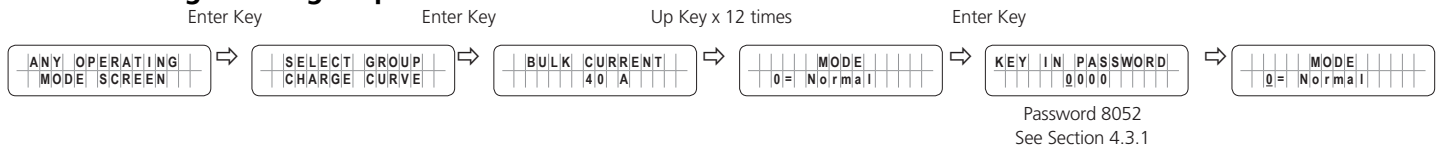

4.4.2.14 ONLINE OPTION (Table 4.1, Parameter Setup Screen No. 14)

This setting is effective only when "On-line" Mode is selected (*Parameter "MODE" is set at option "1=On-line"*). See Section 4.4.2.13). The default setting is: 0=Option 1. Programming steps are given below:

4.4.2.14.1 Programming Steps for Parameter "ONLINE OPTION"

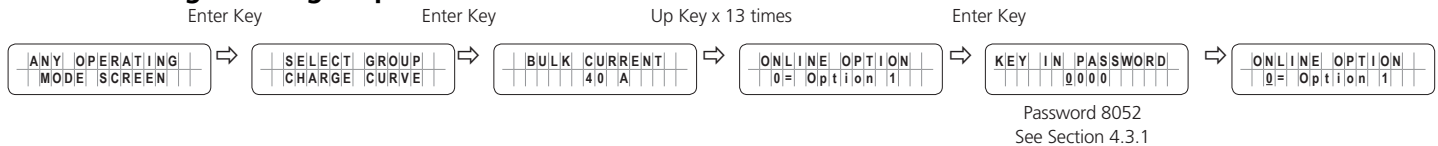

Details of the two options are given below:

0= Option 1 (Default):

- The Transfer Relay will be switched ON (energized) if the battery voltage drops to the voltage threshold of "LOW VOLT ALARM" (Section 4.4.2.8) or lower for sustained period = "GS DETECT TIME" (Section 4.4.2.16). The EVO™ will change over to "Charging Mode" and qualified AC input from the AC input source will be passed through to the AC Output and at the same time, the Internal AC Charger will start charging the battery. If an external Solar Charge Controller is also connected to the External Charging Terminals (3 and 4, Fig 2.1 in the attached Owner's Manual for EVO-2212/3012/2224/4024), the internal AC Charger will limit the charging current to a value = (Programmed Value of Bulk Current – Value of Current fed from the external Solar Charge Controller).
- Charging will be carried out till the batteries are charged as follows and then, the Transfer Relay will be de-energized to exit Charging Mode and revert back to Inverting Mode:
 - For Parameter "CHARGING PROFILE" (Section 4.4.2.21) set for 3 Stage Charging Profile as per: (i) "Option "0 = 3 Stage Type 0", (ii) Option "1 = 3 Stage Type 1" and (iii) Option "2 = 3 Stage Type 2"
 - The Transfer Relay will be de-energized to exit Charging Mode and revert to Inverting Mode as soon as the battery bank is charged to the voltage threshold set by parameter "FLOATING VOLTAGE" (Section 4.4.2.4)
 - For Parameter "CHARGING PROFILE" (Section 4.4.2.21) set for 2 Stage Charging Profile as per "Option "3 = 2 Stage Type 1"
 - The Transfer Relay will be de-energized to exit Charging Mode and revert to Inverting Mode when the battery bank is charged to voltage threshold set by parameter "ABSORP VOLTAGE"

(Section 4.4.2.2) and remains at this level for time period set by parameter "ABSORP TIME" (Section 4.4.2.19)

- o **For Parameter "CHARGING PROFILE" (Section 4.4.2.21) set for 2 Stage Charging Profile as per "Option 4 = 2 Stage Type 2"**
 - The Transfer Relay will be de-energized to exit Charging Mode and revert to Inverting Mode when the battery bank is charged to voltage threshold set by parameter "ABSORP VOLTAGE" (Section 4.4.2.2) and remains at this level for time period of *6 min*
- o **For Parameter "CHARGING PROFILE" (Section 4.4.2.21) set for 2 Stage Charging Profile as per "Option 3 = 2 Stage Type 3"**
 - The Transfer Relay will be de-energized to exit Charging Mode and revert to Inverting Mode when the battery bank is charged to voltage threshold set by parameter "ABSORP VOLTAGE" (Section 4.4.2.2) and subsequently, the charging current drops to threshold set by parameter "ABSORP EXIT AMPS" (Section 4.4.2.20)

1= Option 2:

- The Transfer Relay will be switched ON (energized) if the battery voltage drops to "LOW VOLT ALARM" (Section 4.4.2.8), or lower for sustained period = "GS DETECT TIME" (Section 4.4.2.16). The EVO™ will change over to "Charging Mode" and qualified AC input from the Grid will be passed through to the AC Output and at the same time, the Internal AC Charger will start charging the battery. If an external Solar Charge Controller is also connected to the External Charging Terminals (3 and 4, Fig 2.1 in Owner's Manual for Evolution™ Series Inverter/Charger), the internal AC Charger will limit the charging current to a value = (Programmed Value of Bulk Current – Value of Current fed from the external Solar Charge Controller).
- Charging will proceed as per the Charging Profile selected through parameter "CHARGING PROFILE" (Section 4.4.2.21)
- The Transfer Relay will be switched OFF (de-energized) after the programmed value of "GEN OFF DELAY" (Section 4.4.2.18) counted from the time the battery voltage rises to the programmed value of "RESET VOLTAGE" (Section 4.4.2.7). The unit will exit "Charging Mode" and revert to "Inverting" Mode.

4.4.2.15 RESET TO BULK (Table 4.1, Parameter Setup Screen No. 15)

Refer to the description of 6 types of charging profiles under parameter "CHARGING PROFILE" (Section 4.2.2.21). Parameter "RESET TO BULK" sets the value of battery voltage at which the charger will terminate the current charging stage of the selected "CHARGING PROFILE" & restart charging from the beginning i.e. from the first "BULK CURRENT" stage.

4.4.2.15.1 Programming Steps for Parameter "RESET TO BULK"

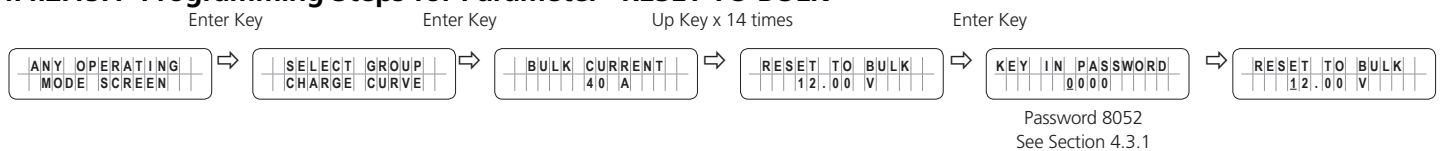

4.4.2.16 GS DETECT TIME (Table 4.1, Parameter Setup Screen No. 16)

This parameter is a Programmable Timer (0-600sec; Default: 10 sec) that is used for programming On-Line / Off Line UPS Modes (Section 4.4.2.13) and Automatic Starting and Stopping of Generator (Section 4.8.2.5 under "Relay Function"). The Timer sets the duration the battery voltage has to remain at threshold of "LOW VOLT ALARM" (Section 4.4.2.8), or lower before the following actions are initiated:

- **Automatic Starting and Stopping of Generator:** Switching ON (energizing) the Status Relay to initiate Generator starting
- **On-Line Mode:** Switching ON of the Transfer Relay to transfer from “Inverting” Mode to “Charging” Mode

4.4.2.16.1 Programming Steps for Parameter “GS DETECT TIME”

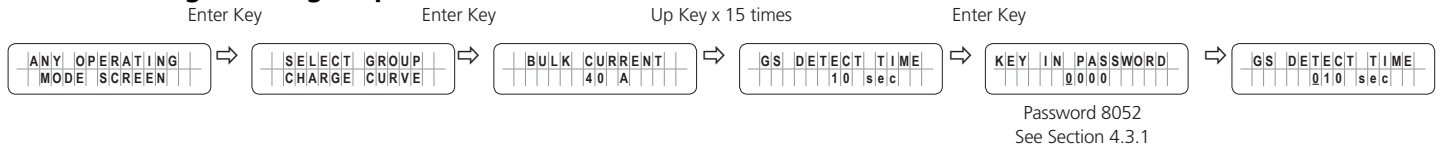

4.4.2.17 GEN ON TIME (Table 4.1, Parameter Setup Screen No. 17)

This parameter is a Programmable Timer (0-240min; Default: 60 min) that is used for programming Automatic Starting and Stopping of Generator (Section 4.8.2.5.2.3 under “Relay Function”: Option 4=Generator 2). The Timer sets the duration the Generator will remain ON from the time the Status Relay has been switched ON (energized). The Status Relay will switch ON (energize) and start the Generator if the battery voltage remains at threshold of “LOW VOLT ALARM” condition (Section 4.4.2.8), or lower for continuous period = “GS DETECT TIME” (Section 4.4.2.16).

4.4.2.17.1 Programming Steps for Parameter “GEN ON TIME”

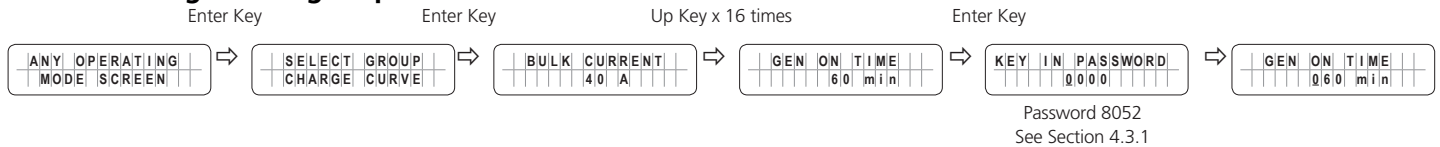

4.4.2.18 GEN OFF DELAY (Table 4.1, Parameter Setup Screen No. 18)

This parameter is a Programmable Timer (0-240min; Default: 60 min) that is used for the following:

- **Programming Automatic Starting and Stopping of Generator (Section 4.8.2.5.2.2 under “Relay Function”: 3=Generator 1):** The Timer sets the time period the batteries are required to remain charged at the desired programmed level of voltage = “RESET VOLTAGE” (Section 4.4.2.7), or higher before the Status Relay is switched OFF (de-energized) to stop the Generator
- **“ONLINE OPTION” (Section 4.4.2.14); “1=Option 2”:** The Timer sets the time period the batteries are required to remain charged at the desired programmed level of voltage = “RESET VOLTAGE” (Section 4.4.2.7), or higher before the Transfer Relay is switched OFF (de-energized) to exit “Charging” Mode and revert to “Inverting” Mode.

4.4.2.18.1 Programming Steps for Parameter “GEN OFF DELAY”

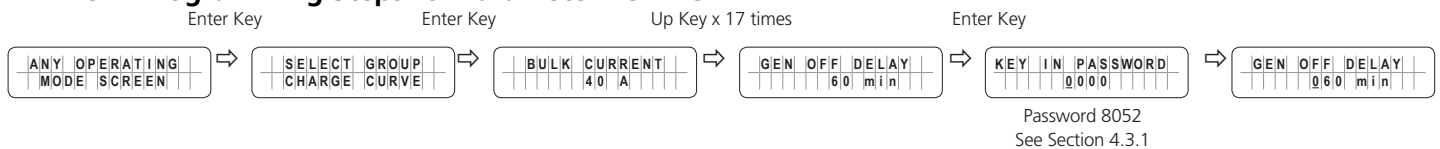

4.4.2.19 ABSORP TIME (Table 4.1, Parameter Setup Screen No. 19)

Parameter “ABSORP TIME” is used to set the time the charger will remain in Absorption Stage when the following options for programming parameter “Charging Profile” (See Section 4.4.2.21) are selected:

- 1=3 Stage Type 1
- 3=2 Stage Type 1

i INFO

When using Charging Profile options (i) "1=3Stage Type 1" or (ii) "3=2Stage Type1, a nearly fully charged battery may be overcharged / boil if the programmed duration of "ABSORP TIME" is excessively long. Care should be taken to determine the time the battery is required to remain in Absorption Stage ("ABSORP TIME") based on the application and then, set programming parameter "ABSORP TIME" accordingly

Programmable range is 0 – 600 min. Default value is 60 min

4.4.2.19.1 Programming Steps for Parameter "ABSORP TIME"

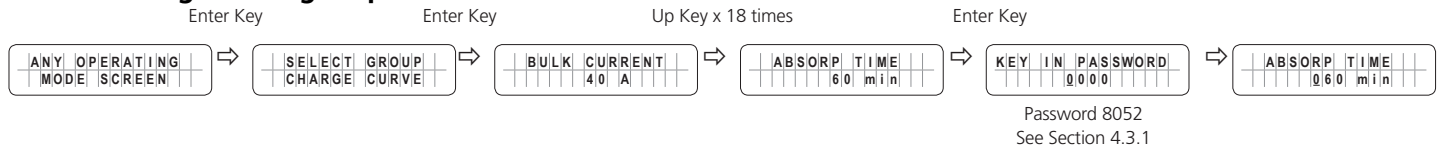

4.4.2.20 ABSORP EXIT AMPS (Table 4.1, Parameter Setup Screen No. 20)

Parameter "ABSORP EXIT AMPS" is used to set the value of the charging current at which the charger will exit Absorption Stage and transition to Float Stage when the following option for programming parameter "Charging Profile" (See Section 4.4.2.21) is selected"

- 2=3 Stage Type 2

Programmable range is 0 – 20A. Default value is 4A

4.4.2.20.1 Programming Steps for Parameter "ABSORP EXIT AMPS"

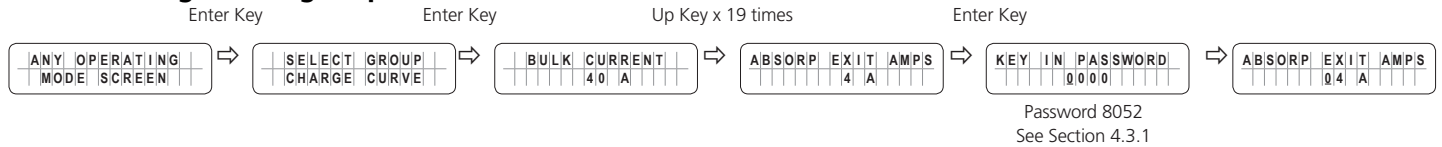

4.4.2.21 CHARGING PROFILE (Table 4.1, Parameter Setup Screen No. 21)

Parameter "CHARGING PROFILE" provides 6 options for Charging Profiles that are designed to cover various charging requirements for Lead Acid, Nickel-Zinc (Ni-Zn) and Lithium Ion Batteries.

i INFO

7th Charging Profile i.e. 4-Stage Adaptive Charging Profile for Equalization is also available and can be activated at any time during charging taking place under 1 of the 6 Charging Profile options given at Section 4.4.2.21 above. Procedure to activate 4-Stage Adaptive Charging Profile for Equalization is described under programming parameter "EQUALIZE- 4 STAGES" at Section 4.4.2.12

The 6 options under parameter "CHARGING PROFILE" are as follows:

- 0 = 3 Stage Adaptive (Default)
- 1 = 3 Stage Type 1
- 2 = 3 Stage Type 2
- 3 = 2 Stage Type 1
- 4 = 2 Stage Type 2
- 5 = 2 Stage Type 3

3-Stage Adaptive Charging Profile option "0 = 3 Stage Adaptive (*Shown as "0=3 Stg.Adaptive" in the programming screen*) **is the default charging profile applicable for Lead Acid Batteries**

Details of the 6 programmable charging profiles under programming parameter "CHARGING PROFILE" are given in TABLE 4.3 below.



CAUTION!

The Battery Management System (BMS) that comes with the type of Lithium Ion Battery being used will need to have control over charging and discharging of the battery. For this, any of Pins 1/2/3/4 and 5/6/7/8 of the Temperature Sensor Jack (6, Fig 4.1 / Pinout at Fig 3.13 in the attached EVO-2212/3012/2224/4024 Owner's Manual) may be used to feed potential free contact closing signal from the BMS to "Stop Charging" or "Stop Inverting" *[Refer to Section 4.4.2.22.2 for details]*



ATTENTIONS!

Le système de gestion de la batterie (BMS) fourni avec le type de batterie au lithium-ion utilisé doit pouvoir contrôler la charge et le déchargement de la batterie. Pour cela, l'un des broches 1/2/3/4 et 5/6/7/8 de la prise du capteur de température (6, Fig 4.1 / Pinout à la Fig 3.13 dans le manuel d'utilisation EVO-2212/3012/2224/4024 fourni) peut être utilisé pour alimenter le signal de fermeture de contact libre de potentiel du système de management jusqu'à "Stop Charging" ou "Stop Inverting" *[Voir la section 4.4.2.22.2 pour plus de détails]*

TABLE 4.3 CHARGING PROFILE OPTIONS FOR 3 AND 2-STAGE CHARGING

Srl No.	Options under Programming Parameter "CHARGING PROFILE"	Charging Stages	Battery Type
1	<p>0 = 3 Stage Adaptive (Shown as "0=3 Stg Adaptive" in the programming screen)</p> <p>NOTES:</p> <p>1. This is the default setting</p> <p>2. This is a 3-Stage, Adaptive Profile with "Adaptive Time Algorithm" for the Absorption Stage (For details, refer to Section 5.7.2 of the attached Owner's Manual for EVO-2212/3012/2224/4024)</p>	<p>1. Stage 1 – Bulk Stage (See Section 5.7.1.1 of the attached EVO-2212/3012/2224/4024 Manual for details):</p> <ul style="list-style-type: none"> Charge at constant current = the programmed value of parameter "BULK CURRENT" (Default value is 40A. For details of programming range & procedure, refer to Section 4.4.2.1) Transition to Absorption Stage when voltage rises to the set value for programming parameter "ABSORP VOLTAGE" (Default value is 14.4V for EVO-2212/3012 and 28.8V for EVO-2224/4024. For details of programming range & procedure, refer to Section 4.4.2.2) <p>2. Stage 2 - Absorption Stage (See Section 5.7.2 of the attached EVO-2212/3012/2224/4024 Manual for details):</p> <ul style="list-style-type: none"> Charge at constant voltage = the programmed value for parameter "ABSORP VOLTAGE". (Default value is 14.4V for EVO-2212/3012 and 28.8V for EVO-2224/4024. For details of programming range & procedure, refer to Section 4.4.2.2) Adaptive Time Algorithm: Time in Absorption Stage is computed automatically based on time in Bulk Stage (For details, refer to Section 5.7.2 of the Owner's Manual for EVO-2212/3012/2224/4024). Transition to Float Stage thereafter. <p>3. Stage 3 - Float Stage (See Section 5.7.3 of the attached EVO-2212/3012/2224/4024 Manual for details):</p> <ul style="list-style-type: none"> Charge at constant voltage = the programmed value for parameter "FLOATING VOLTAGE". (Default value is 13.5V for EVO-2212/3012 & 27.0V for EVO-2224/4024. For details of programming range & procedure, refer to Section 4.4.2.4) Reset to Bulk Stage under the following conditions: <ol style="list-style-type: none"> If the AC input fails or is switched off and is restored subsequently. If battery voltage falls to the programmed value of parameter "RESET TO BULK". (Default value is 12.0V for EVO-2212/3012 & 24.0V for EVO-2224/4024. For details of programming range & procedure, refer to Section 4.4.2.15) If the charger remains in the Float Stage for 10 days 	<p>– Lead Acid: Flooded and sealed – AGM/ Gel Cell</p> <p>– ENSURE that there are no other DC load(s) on the batteries. Load(s) on the battery may drain full or part of the charging current and will upset the "Adaptive Time Algorithm" for Absorption Stage time</p>
2	<p>1=3Stage Type1</p>	<p>1. Stage 1 – Bulk Stage (See Section 5.7.1.1 of the attached EVO-2212/3012/2224/4024 Manual for details):</p> <ul style="list-style-type: none"> Charge at constant current = the programmed value of parameter "BULK CURRENT" (Default value is 40A. For details of programming range & procedure, refer to Section 4.4.2.1) Transition to Absorption Stage when voltage rises to the set value for programming parameter "ABSORP VOLTAGE" (Default value is 14.4V for EVO-2212/3012 and 28.8V for EVO-2224/4024. For details of programming range & procedure, refer to Section 4.4.2.2) <p>2. Stage 2 - Absorption Stage (See Section 5.7.2 of the attached EVO-2212/3012/2224/4024 Manual for details):</p> <ul style="list-style-type: none"> Charge at constant voltage (CV) = the programmed value for parameter "ABSORP VOLTAGE". (Default value is 14.4V for EVO-2212/3012 and 28.8V for EVO-2224/4024. For details of programming range & procedure, refer to Section 4.4.2.2) Remain in Absorption Stage for time duration = programmed value of parameter "ABSORP TIME" (Default value is 60 min. For details of programming range & procedure, refer to Section 4.4.2.19) Transition to Float Stage thereafter. <p>3. Stage 3 - Float Stage (See Section 5.7.3 of the attached EVO-2212/3012/2224/4024 Manual for details):</p> <ul style="list-style-type: none"> Charge at constant voltage = the programmed value of parameter "FLOATING VOLTAGE". (Default value is 13.5V for EVO-2212/3012 & 27.0V for EVO-2224/4024. For details of programming range & procedure, refer to Section 4.4.2.4) Reset to Bulk Stage under the following conditions: <ol style="list-style-type: none"> If the AC input fails or is switched off and is restored subsequently. If battery voltage falls to the programmed value of parameter "RESET TO BULK". (Default value is 12.0V for EVO-2212/3012 & 24.0V for EVO-2224/4024. For details of programming range & procedure, refer to Section 4.4.2.15) If the charger remains in the Float Stage for 10 days 	<p>– Lead Acid: Flooded and sealed – AGM/ Gel Cell</p> <p>– Lithium (See Section 5.11 of EVO-2212/3012/2224/4024 Manual for details)</p>

3	2=3Stage Type2	<p>1. Stage 1 – Bulk Stage (See Section 5.7.1.1 of the attached EVO-2212/3012/2224/4024 Manual for details):</p> <ul style="list-style-type: none"> • Charge at constant current = the programmed value of parameter "BULK CURRENT" (Default value is 40A. For details of programming range & procedure, refer to Section 4.4.2.1) • Transition to Absorption Stage when voltage rises to the set value for programming parameter "ABSORP VOLTAGE" (Default value is 14.4V for EVO-2212/3012 and 28.8V for EVO-2224/4024. For details of programming range & procedure, refer to Section 4.4.2.2) <p>2. Stage 2 - Absorption Stage (See Section 5.7.2 of the attached EVO-2212/3012/2224/4024 Manual for details):</p> <ul style="list-style-type: none"> • Charge at constant voltage = the programmed value for parameter "ABSORP VOLTAGE". (Default value is 14.4V for EVO-2212/3012 and 28.8V for EVO-2224/4024. For details of programming range & procedure, refer to Section 4.4.2.2) • Remain in Absorption Stage till the current reduces to value = the programmed value of parameter "ABSORP EXIT AMPS" (Default value is 4A. For details of programming range & procedure, refer to Section 4.4.2.20) • Transition to Float Stage thereafter. <p>3. Stage 3 - Float Stage (See Section 5.7.3 of the attached EVO-2212/3012/2224/4024 Manual for details):</p> <ul style="list-style-type: none"> • Charge at constant voltage = the programmed value of parameter "FLOATING VOLTAGE". (Default value is 13.5V for EVO-2212/3012 & 27.0V for EVO-2224/4024. For details of programming range & procedure, refer to Section 4.4.2.4) • Reset to Bulk Stage under the following conditions: <ol style="list-style-type: none"> If the AC input fails or is switched off and is restored subsequently. If battery voltage falls to the programmed value of parameter "RESET TO BULK". (Default value is 12.0V for EVO-2212/3012 & 24.0V for EVO-2224/4024. For details of programming range & procedure, refer to Section 4.4.2.15). If the charger remains in the Float Stage for 10 days 	<ul style="list-style-type: none"> - Lead Acid: Flooded and Sealed – AGM/ Gel Cell - Lithium (See Section 5.11 EVO-2212/3012/2224/4024 Manual for details)
4	3=2Stage Type1	<p>1. Stage 1 – Bulk Stage (See Section 5.7.1.1 of the attached EVO-2212/3012/2224/4024 Manual for details):</p> <ul style="list-style-type: none"> • Charge at constant current = the programmed value of parameter "BULK CURRENT" (Default value is 40A. For details of programming range & procedure, refer to Section 4.4.2.1) • Transition to Absorption Stage when voltage rises to the set value for programming parameter "ABSORP VOLTAGE" (Default value is 14.4V for EVO-2212/3012 and 28.8V for EVO-2224/4024. For details of programming range & procedure, refer to Section 4.4.2.2) <p>2. Stage 2 - Absorption Stage (See Section 5.7.2 of the attached EVO-2212/3012/2224/4024 Manual for details):</p> <ul style="list-style-type: none"> • Charge at constant voltage = the programmed value for parameter "ABSORP VOLTAGE". (Default value is 14.4V for EVO-2212/3012 and 28.8V for EVO-2224/4024. For details of programming range & procedure, refer to Section 4.4.2.2) • Remain in Absorption Stage till the time in Absorption Stage is = the programmed value of parameter "ABSORP TIME" (Default value is 60 min. For details of programming range & procedure, refer to Section 4.4.2.19) • Switch off charging after expiry of programmed value of parameter "ABSORP TIME" (Default value is 60 min. For details of programming range & procedure, refer to Section 4.4.2.19) • Reset to Bulk Stage under the following conditions: <ol style="list-style-type: none"> If the AC input from the Grid/Generator is disconnected and is reconnected. If battery voltage falls to the programmed value of parameter "RESET TO BULK". (Default value is 12.0V for EVO-2212/3012 & 24.0V for EVO-2224/4024. For details of programming range & procedure, refer to Section 4.4.2.15). 	<ul style="list-style-type: none"> - Lithium (See Section 5.11 of EVO-2212/3012/2224/4024 Manual for details) - Nickel Zinc (See Section 5.10 of EVO-2212/3012/2224/4024 Manual for details)

5	4=2Stage Type2	<p>1. Stage 1 – Bulk Stage (See Section 5.7.1.1 of the attached EVO-2212/3012/2224/4024 Manual for details):</p> <ul style="list-style-type: none"> Charge at constant current = the programmed value of parameter "BULK CURRENT" (Default value is 40A. For details of programming range & procedure, refer to Section 4.4.2.1) Transition to Absorption Stage when voltage rises to the set value for programming parameter "ABSORP VOLTAGE" (Default value is 14.4V for EVO-2212/3012 and 28.8V for EVO-2224/4024. For details of programming range & procedure, refer to Section 4.4.2.2) <p>2. Stage 2 - Absorption Stage (See Section 5.7.2 of the attached EVO-2212/3012/2224/4024 Manual for details):</p> <ul style="list-style-type: none"> Charge at constant voltage = the programmed value for parameter "ABSORP VOLTAGE". (Default value is 14.4V for EVO-2212/3012 and 28.8V for EVO-2224/4024. For details of programming range & procedure, refer to Section 4.4.2.2) Remain in Absorption Stage Reset to Bulk Stage under the following conditions: <ol style="list-style-type: none"> If the AC input fails or is switched off and is restored subsequently If battery voltage falls to the programmed value of parameter "RESET TO BULK". (Default value is 12.0V for EVO-2212/3012 & 24.0V for EVO-2224/4024. For details of programming range & procedure, refer to Section 4.4.2.15). 	<p>– Lithium (See Section 5.11 of EVO-2212/3012/2224/4024 Manual for details)</p>
6	5=2Stage Type3	<p>1. Stage 1 – Bulk Stage (See Section 5.7.1.1 of the attached EVO-2212/3012/2224/4024 Manual for details):</p> <ul style="list-style-type: none"> Charge at constant current = the programmed value of parameter "BULK CURRENT" (Default value is 40A. For details of programming range & procedure, refer to Section 4.4.2.1) Transition to Absorption Stage when voltage rises to the set value for programming parameter "ABSORP VOLTAGE" (Default value is 14.4V for EVO-2212/3012 and 28.8V for EVO-2224/4024. For details of programming range & procedure, refer to Section 4.4.2.2) <p>2. Stage 2 - Absorption Stage (See Section 5.7.2 of the attached EVO-2212/3012/2224/4024 Manual for details):</p> <ul style="list-style-type: none"> Charge at constant voltage = the programmed value for parameter "ABSORP VOLTAGE". (Default value is 14.4V for EVO-2212/3012 and 28.8V for EVO-2224/4024. For details of programming range & procedure, refer to Section 4.4.2.2) Remain in Absorption Stage till the current reduces to value = the programmed value of parameter "ABSORP EXIT AMPS" (Default value is 4A. For details of programming range & procedure, refer to Section 4.4.2.20) Switch off charging after the current reduces to value = the programmed value of parameter "ABSORP EXIT AMPS" (Default value is 4A. For details of programming range & procedure, refer to Section 4.4.2.20) Reset to Bulk Stage under the following conditions: <ol style="list-style-type: none"> If the AC input fails or is switched off and is restored subsequently If battery voltage falls to the programmed value of parameter "RESET TO BULK". (Default value is 12.0V for EVO-2212/3012 & 24.0V for EVO-2224/4024. For details of programming range & procedure, refer to Section 4.4.2.15). 	<p>– Lithium (See Section 5.11 of EVO-2212/3012/2224/4024 Manual for details)</p> <p>– Nickel Zinc (See Section 5.10 of EVO-2212/3012/2224/4024 Manual for details)</p>

4.4.2.21.1 Programming Steps for Parameter "CHARGING PROFILE"

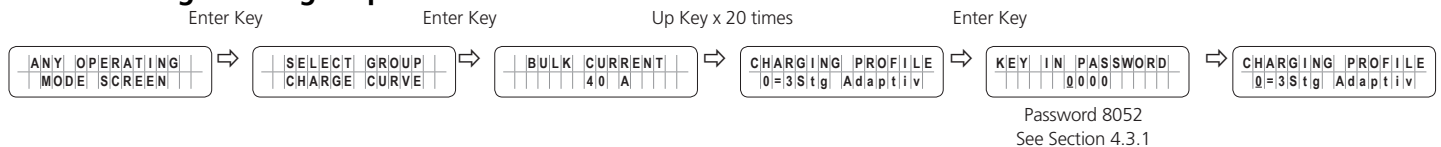

4.4.2.22 BATTERY TYPE (Table 4.1, Parameter Setup Screen No. 22)

4.4.2.22.1 General Information

Parameter "BATTERY TYPE" is used to change the functionality of RJ-45 Jack marked "Battery Temp. Sensor" on the front panel of EVO [6, Fig 2.1 in EVO-2212/3012/2224/4024 Owner's Manual]. The following 2 programming options are available:

a) **Option 1 - "0=Lead Acid" (Default setting):** With this default setting, the RJ-45 Jack will be set to accept input from the Battery Temperature Sensor EVO-BCTS [*Fig 2.5(a) in EVO-2212/3012/2224/4024 Owner's Manual*] when Lead Acid or Nickel-Zinc (Ni-Zn) batteries are being used. Input from the Battery Temperature Sensor will be used to compensate the charging voltages based on the temperature of the Lead Acid or Nickel-Zinc (Ni-Zn) batteries. *Please refer to Section 5.5 of EVO-2212/3012/2224/4024 Owner's Manual for more details on temperature compensation for Lead Acid and Nickel-Zinc (Ni-Zn) batteries*

b) **Option 2 - "1=Lithium Ion":** With this setting, the RJ-45 Jack will be programmed to receive and process protection control signals "Stop Charging" or "Stop Inverting" from Lithium Battery Management System (BMS). *Application of this setting is explained at Section 4.4.2.22.2 below*

4.4.2.22.2 Stop Charging" and "Stop Inverting" Control by Lithium Ion Battery Management System (BMS)

For protection against over-voltage / over-temperature / over-discharge, Lithium Ion Battery Management Systems (BMS) will normally have capability of providing potential free relay contact closure signal that could be fed to Inverter Charger to stop charging or stop inverting. For this, the BMS will normally use miniature, Normally Open (1-Form-A), Open Drain Opto-Isolated DC Solid-State Relay (SSR). The Solid-State Relay output terminals in the BMS are normally marked "+" (*Drain of Mosfet Switch*) and "-" (*Source of Mosfet Switch*). Example of this type of relay is IXYS Part No. "CPC1002N" (60V, 700mA rating).

The following 2 types of signals are normally used by the BMS for on/off control of charging and inverting operation of the Inverter-Charger:

- **"Stop Charging" Signal:** In case of (i) over voltage of individual cell / overall battery pack, or (ii) over temperature of individual cell or overall battery pack, the signal will be "enabled" and SSR contacts will close [*Drain (+) and Source (-) Terminals will be shorted*].
- **"Stop Inverting" Signal:** In case of deep discharge of the battery to the level of Low Battery Cut Off Voltage, the signal will be "enabled" and the SSR contacts will close [*Drain (+) and Source (-) Terminals will be shorted*].

If the above two protection functions of the BMS i.e. "*Stop Charging*" and "*Stop Inverting*" are to be used for on/off control of charging and inverting operations of EVO Inverter-Charger, the following actions will be required to be undertaken:

- a) Programming parameter **"BATTERY TYPE"** must be changed from Option 1 - "0=Lead Acid" (Default setting) to Option 2 - "1=Lithium" [*see Section 4.4.2.21 above*]. With this setting, the function of front panel RJ-45 Jack marked "Battery Temp. Sensor: (6, Fig 2.1 in the attached EVO-2212/3012/2224/4024 Owner's Manual) will change from accepting and processing battery temperature signal from the Battery Temperature Sensor EVO-BCTS to accepting and processing potential free relay contact closure signal from the Solid-State Relay from the BMS to stop charging /inverting.
- b) **Wiring Connection:** Output from the SSR Terminals on the Lithium Battery BMS should be wired to the RJ-45 Jack marked "Battery Temp. Sensor" (6, Fig 2.1 in the attached EVO-2212/3012/2224/4024 Owner's Manual) as follows:
 - Connect terminal marked "+" on the SSR (Drain of Mosfet switch inside SSR) to any of pins 1/2/3/4 of RJ-45 Jack (Pinout shown below)
 - Connect terminal marked "-" on the SSR (Source of Mosfet switch inside SSR) to any of pins 5/6/7/8 of RJ-45 Jack (Pinout shown below)

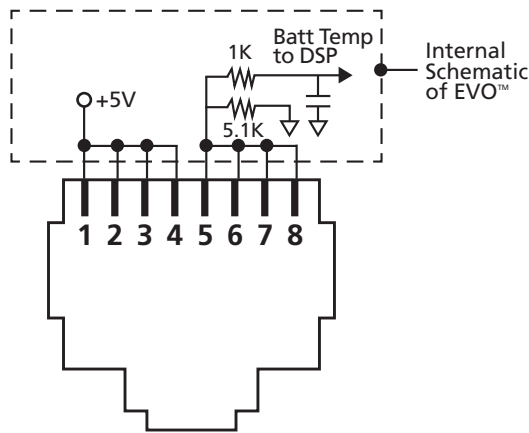

Pinout of RJ-45 Jack on the Front Panel of EVO Inverter/Charger
 (6, Fig 2.1 in the attached EVO-2212/3012/2224/4024 Owner's Manual)

When the Drain-Source terminals of the BMS close, Pins 1/2/3/4 and 5/6/7/8 of RJ-45 Jack will be shorted. The following actions will be activated in EVO:

- **EVO in Charging Mode:** Charging will stop (*Internally, the EVO will be in Charging Mode, but the charging current will be reduced to 0A*). During this condition, 19 display screens will be available as shown in the Menu Map for Display Screens during “CHGR STOP BY BMS” at Fig 3.5 under Section 3.9.
- Under this condition, the 1st Line of the 19 Screens will show “CHR STOP BY BMS”. Example of Screen No. 1 of 19 Screens is shown below:

CHGR	STOP	BY	BMS
OUTPUT	120.00	V	

NOTE: The 19 “CHGR STOP BY BMS” display screens shown in Fig 3.5 are the same as the 19 display screens shown for Menu Map for screens for “Charging Mode” (Fig 3.2 – Column 3 under heading “GROUP 3: CHARGING MODE”) but with the 1st line replaced with “CHGR STOP BY BMS”

- **EVO in Inverting Mode:** Inverting will stop (*Internally, the EVO will enter Standby Mode*). During this condition, 7 display screens will be available as shown in the Menu Map for display screens during “INV STOP BY BMS” at Fig 3.6 under Section 3.10. Example of Screen No. 1 of 7 Screens is shown below:

INV	STOP	BY	BMS
BATTERY	12.000	V	

NOTE: The 7 “INV STOP BY BMS” display screens shown in Fig 3.6 are the same as the 7 display screens shown for Menu Map for “Standby Mode” (Fig 3.2 – Column 2 under heading “GROUP 1: STANDBY MODE”) but with the 1st line replaced with “INV STOP BY BMS”

NOTE: Parameter "CHARGING PROFILE" has been set at default option "0=3 Stage Adaptive" for Lead Acid Batteries. This parameter will be required to be programmed to select the desired charging profile for the Lithium Ion Battery from the following options:

- 1=3 Stage Type 1
- 2=3 Stage Type 2
- 3=2 Stage Type 1
- 4=2 Stage Type 2
- 5=2 Stage Type 3

[For details, please refer to parameter "CHARGING PROFILE" explained under Section 4.4.2.21]

4.4.2.22.3 Programming Steps for Parameter "BATTERY TYPE"

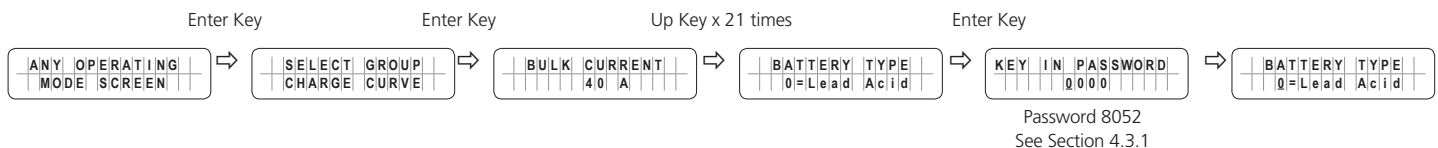

4.4.2.23 SAFE CHARGING *(Table 4.1, Parameter Setup Screen No. 23)*

4.4.2.23.1 General Information

Programming parameter "SAFE CHARGING" is a Timer *(0 to 300 min; Default: 0 min)* that may be used for the following operational conditions / requirements:

- The unit is programmed to operate in Normal *[Off-line]* Mode *[Parameter MODE set to "0= Normal" – See Section 4.4.2.13]* i.e. AC input power is the primary source of AC power and EVO's Inverter Section is the backup source.
- The AC load(s) that are fed with backup power from EVO have very high inrush current.
- When AC input power is restored during "Battery low voltage!" fault condition *[Section 7, Srl. 1 of Table 7.1]*, EVO will exit fault condition and change to "Charging Mode" *[say, "Condition 1"]*. The AC input power may fail again within a short period of time and EVO will immediately revert back to "Inverting Mode" *[say, "Condition 2"]*. During "Condition 1", the battery voltage may not have risen appreciably higher than the "BATT LOW VOLTAGE" threshold *[Section 4.4.2.9]*. Hence, during "Condition 2", there would be **MORE** likelihood that high inrush current from the AC load(s) would drag the battery voltage down to 9V or lower for EVO-2212/3012 or 18V or lower for EVO-2224/4024. This may trigger "Battery ultra low volt!" fault condition *[Section 7, Srl. 2 of Table 7.1]*. It is, therefore, desirable that when AC input power is restored during "Battery low voltage!" fault condition *(Condition 1)* and fails again *(say Condition 2)*, the AC load(s) should NOT be transferred to the Inverter Section *(under Condition 2)* till the AC input power had been restored *(under Condition 1)* for a minimum safe charging time period set through Timer "SAFE CHARGING" *[Section 4.4.2.23]*

4.4.2.23.2 Initial Settings:

- Timer associated with parameter "SAFE CHARGING" *[Section 4.4.2.23]* is set to > 0 min, say "t" min
- Parameter "LV CUT OFF TIME" *[Section 4.4.2.11.2]* is set to 0 sec to ensure that the unit does not shut down completely if AC input is not restored before expiry of time set through programming parameter "LV CUT OFF TIME" *[Section 4.4.2.11]*

4.4.2.23.3 Operating Sequence

- 1) AC input power is available – EVO operates in “Charging Mode”
- 2) AC input power fails: EVO transfers from “Charging Mode” to “Inverting Mode”
- 3) The battery continues to get discharged. When battery voltage (i) drops to value equal to / lower than the “BATT LOW VOLTAGE” threshold [Section 4.4.2.9] for period equal to LV DETECT TIME [Section 4.4.2.10] or (ii) momentarily drops for 1 ms to 9V or below for EVO-2212/3012 or, 18V or below for EVO-2224/4024, EVO’s Inverter Section is shut down and displays “Battery low voltage! fault / “Battery ultra low voltage!” fault conditions respectively [See Srls. 1 and 2 of Table 7.1, Section 7].
 - As parameter “LV CUT OFF TIME” [Section 4.4.2.11.2] has been set at 0 sec, the EVO does not shut down completely but continues to remain in “Battery low voltage!” / “Battery ultra low voltage!” fault condition
- 4) AC input power is restored and is within the programmed limits of frequency and voltage
- 5) EVO exits “Battery low voltage!” / “Battery ultra low voltage!” and starts operating in “Charging Mode” (say, “Operating Condition 1”)
 - As soon as “Charging Mode” is activated, the Timer associated with parameter “SAFE CHARGING” [Section 4.4.2.23] starts countdown:
 - The “SAFE CHARGING” Timer will countdown to “0” min if AC input remains on for more than the programmed value of “t” min
 - The “SAFE CHARGING” Timer will NOT countdown to “0” min if AC input remains on for period less than the programmed value “t” min
- 6) AC input fails again. The EVO will now operate as follows based on the condition of the “SAFE CHARGING” Timer that recorded the time AC input was available [“Operating Condition 1” mentioned at Srl. 5 above]:
 - “SAFE CHARGING” Timer value has counted down to 0 min: EVO will operate in “Inverting Mode”. As the batteries were re-charged for sizable time period > the programmed time “t” of the “SAFE CHARGING” timer, the battery would have charged appreciably higher than the “BATT LOW VOLTAGE” threshold [Section 4.4.2.9]. Hence, there is **LESS** likelihood that high inrush current from the AC loads would drag the battery voltage down to 9V or lower for EVO-2212/3012 or 18V or lower for EVO-2224/4024 to trigger “Battery ultra low volt!” fault condition [See Section 7, Srl. 2 of Table 7.1]
 - “SAFE CHARGING” Timer value has NOT counted down to 0 min: EVO will **NOT** go to Inverting Mode but to “STANDBY” Mode [See Screen No. 1, of STANDBY MODE screens in Fig 3.2]. As the batteries were re-charged for a short time period < the programmed time “t” of the “SAFE CHARGING” timer (“Operating Condition 1” mentioned at Srl. 5 above), the battery would NOT have charged appreciably higher than the “BATT LOW VOLTAGE” threshold. Hence, there would be **MORE** likelihood that high inrush current from the AC loads would drag the battery voltage down to 9V or lower for EVO-2212/3012 or 18V or lower for EVO-2224/4024 to trigger “Battery ultra low volt!” fault condition (See Section 7, Srl. 2 of Table 7) that would require manual reset.
 - If the battery is charged through external charging source [e.g. solar charging through Charge Controller connected to the battery directly or, through terminals marked “EXT Charger” on the front panel of the unit (3, 4 in Fig 2.1 in the attached Owner’s Manual for EVO-2212/3012/2224/4024)] to voltage threshold set by parameter “RESET VOLTAGE” [Section 4.4.2.7], the EVO will change to “INVERTING MODE”

4.4.2.23.4 Programming Steps for Parameter "SAFE CHARGING"

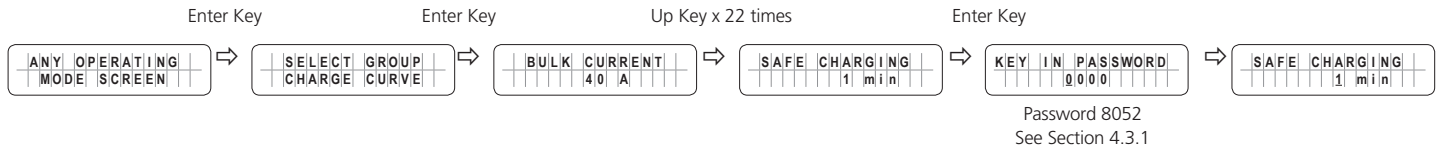

4.5 GROUP 2 PARAMETER SET UP: INPUT SETTING

4.5.1 Programming Ranges & Default Values of Programming Parameters under Parameter Group 2 – INPUT SETTING

Refer to Parameter Group No.2 at Fig 4.1

Table 4.4 below gives details of programmable ranges & default values of parameters under Parameter Group No.2 - "INPUT SETTING". Refer to Fig 4.1 under Section 4.1 for Menu Map for navigating through various parameters under this Group No.2.

TABLE 4.4 Programming Information for Parameter Group No.2 - INPUT SETTING									
Parameter Setup Screen No. for Parameter Group No.2 (Fig 4.1)	Parameter	Setting range				Default value			
		EVO-2212	EVO-3012	EVO-2224	EVO-4024	EVO-2212	EVO-3012	EVO-2224	EVO-4024
1	DEFAULT FREQ	0 = 60Hz; 1 = 50Hz				0 = 60Hz			
2	GRID MAX CURRENT	5 – 40A	5 – 70A	5 – 40A	5 – 70A	30A			
3	GEN MAX CURRENT	5 – 40A	5 – 70A	5 – 40A	5 – 70A	30A			
4	HIGH CUT OFF	50 – 70Hz				65Hz			
5	HIGH RESET	50 – 70Hz				64Hz			
6	LOW CUT OFF	40 – 60Hz				55Hz			
7	LOW RESET	40 – 60Hz				56Hz			
8	SYNC GRID	0=Fine 1=Coarse				0=Fine			
9	SYNC GEN	0=Fine 1=Coarse				1=Coarse			
10	INPUT OC PROTECT	0=INV mode 1=Shutdown				0=INV mode			
11	INPUT RECOVERY	0=Buffered 1=Direct				0=Buffered			

4.5.2 Description of Parameters under Parameter Group No.2 – INPUT SETTING



The values shown under various screens are the Default Values for EVO-2212

4.5.2.1 DEFAULT FREQ: *(Table 4.4, Parameter Setup Screen No.1)*

Default frequency sets the Inverter frequency, which is also the standard frequency for AC input.

4.5.2.1.1 Programming Steps for Parameter "DEFAULT FREQUENCY"

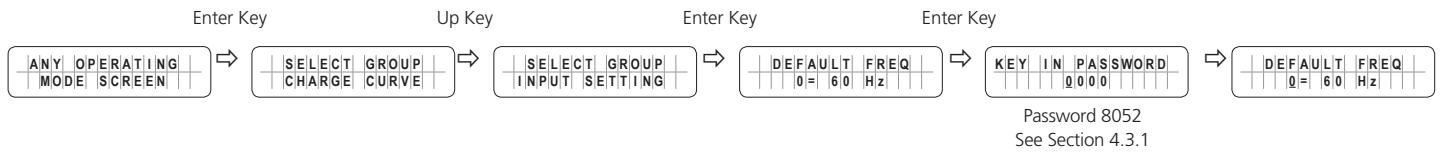

4.5.2.2 GRID MAX CURRENT *(Table 4.4, Parameter Setup Screen No.2)*

In Charging Mode, the net AC input current from the AC input terminals marked "GRID" is the sum of the AC side charging current and the pass through load current. Based on the rated capacity of the AC input source connected to these terminals, the net AC input current will be required to be limited to prevent overloading of the Input Branch Circuit connected to these terminals.

EVO™ Series has a very powerful battery charger that will require a proportionate higher AC input current from the AC input source. The Input Branch Circuit will also be required to provide current to the AC loads. The desired maximum value of input current from the AC input terminals marked "GRID" can be programmed (*Default is 30A*). The EVO™ will automatically reduce charging current to support the AC loads on priority and use whatever is extra for charging. This will prevent overloading of the AC Input Branch Circuit. If the net AC input current is 1A more than the value of parameter "GRID MAX CURRENT" for 1 sec, the AC side charging current is clawed back to ensure that "GRID MAX CURRENT" value is not exceeded. If the value of pass through load current increases to a value of 1A more than the programmed value of "GRID MAX CURRENT" for 5 sec, input over current protection will be activated based on option to either transfer to Inverting Mode or to shut down the EVO (*Refer to details of these 2 options under parameter **INPUT OC PROTECT** at Section 4.5.2.10*):

4.5.2.2.1 Programming Steps for Parameter "GRID MAX CURRENT"

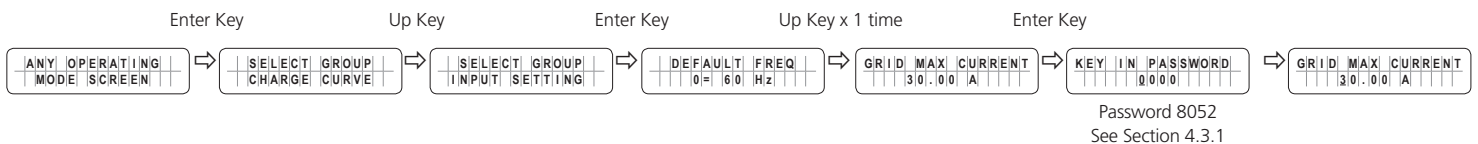

4.5.2.3 GEN MAX CURRENT *(Table 4.4, Parameter Setup Screen No.3)*

In Charging Mode, the net AC input current from the AC input terminals marked "GEN" is the sum of the AC side charging current and the pass through load current. Based on the rated capacity of the AC source connected to AC Input Terminals marked "GEN", the net AC input current will be required to be limited to prevent overloading of the AC input source.

EVO™ Series has a very powerful battery charger that will require a proportionate higher AC input current from the AC input source. The AC source connected to AC input terminals marked "GEN" will also be required to provide current to the AC loads. The desired maximum value of input current from the AC input source connected to AC input terminals marked "GEN" can be programmed (*Default is 30A*). The EVO™ will automatically reduce charging current to support the AC loads on priority and use whatever is extra for charging. This will prevent overloading of the AC input source. If

the net AC input current is 1A more than the value of parameter "GEN MAX CURRENT" for 1 sec, the AC side charging current is clawed back to ensure that "GEN MAX CURRENT" value is not exceeded. If the value of pass through load current increases to a value of 1A more than the programmed value of "GEN MAX CURRENT" for 5 sec, input over current protection will be activated based on option to either transfer to Inverting Mode or to shut down the EVO (*Refer to details of these 2 options under parameter **INPUT OC PROTECT** at Section 4.5.2.10*):

4.5.2.3.1 Programming Steps for Parameter "GEN MAX CURRENT"

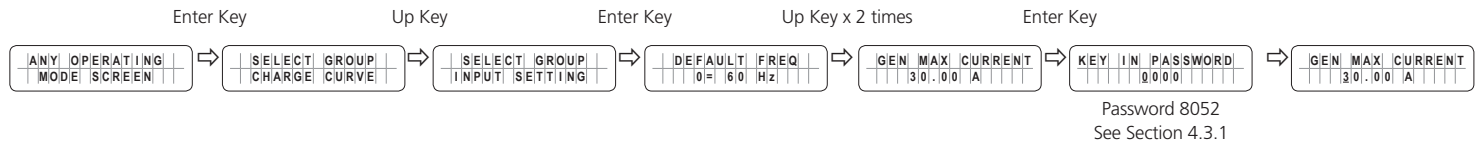

4.5.2.4 HIGH CUT OFF (Table 4.4, Parameter Setup Screen No.4)

If the AC input frequency is over the value of "HIGH CUT OFF" when in "Charging Mode", the EVO™ Inverter/Charger will transfer to Inverting Mode.

4.5.2.4.1 Programming Steps for Parameter "HIGH CUT OFF"

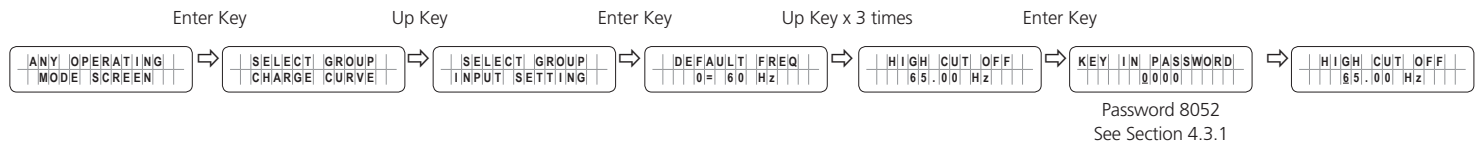

4.5.2.5 HIGH RESET (Table 4.4, Parameter Setup Screen No.5)

This is the reset frequency at which the unit will revert to "Charging Mode" after it has switched over to "Inverter Mode" due to input frequency rising above "HIGH CUT OFF".

4.5.2.5.1 Programming Steps for Parameter "HIGH RESET"

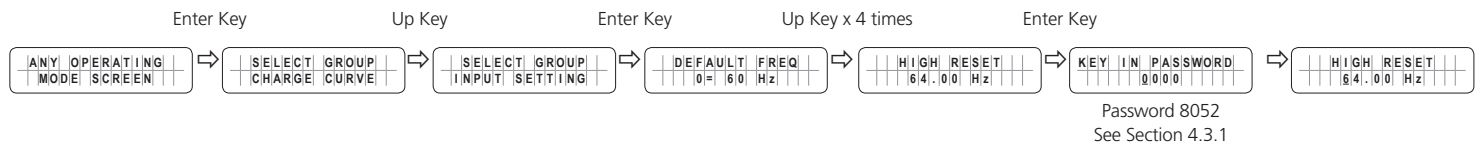

4.5.2.6 LOW CUT OFF (Table 4.4, Parameter Setup Screen No.6)

If the AC input frequency is below "LOW CUT OFF" value when in "Charging Mode", the EVO™ Inverter/Charger will transfer to Inverting Mode.

4.5.2.6.1 Programming Steps for Parameter "LOW CUT OFF"

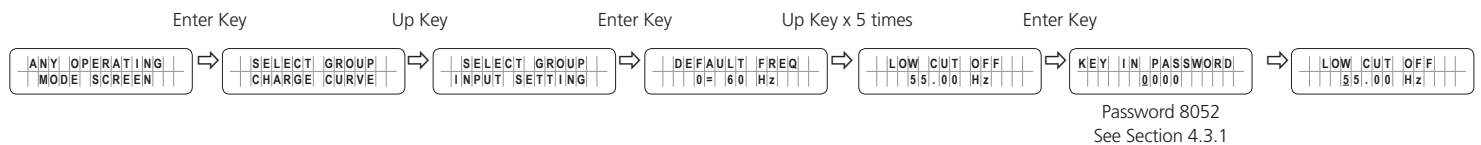

4.5.2.7 LOW RESET (Table 4.4, Parameter Setup Screen No.7)

This is the reset frequency at which the unit will revert to "Charging Mode" after it has switched over to "Inverting

Mode" due to input frequency falling below "LOW CUT OFF".

4.5.2.7.1 Programming Steps for Parameter "LOW RESET"

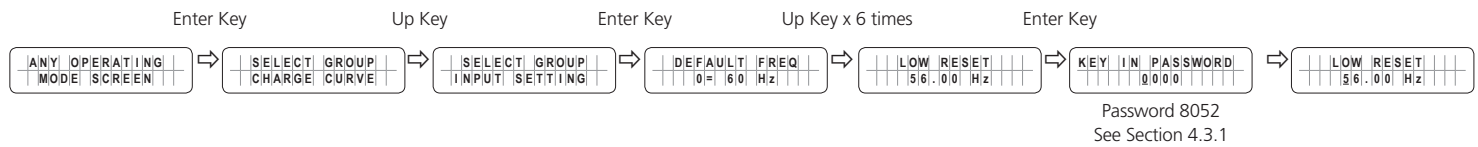

4.5.2.8 SYNC GRID (Table 4.4, Parameter Setup Screen No.8)

In EVO™, the frequency and phase of the Inverter Section are always kept synchronized with the AC input source connected to terminals marked "GRID" (4,5,6 in Fig 2.3). This facilitates faster and safer transfer of power between the Inverter Section and the AC input source. *For supplementary details on synchronized transfer of AC power, please refer to Sections 4.5.4 to 4.5.7 of the Owner's Manual for EVO-2212/3012/2224/4024.*

Parameter "SYNC GRID" is used to program the desired *sensitivity* of frequency and phase synchronization of the Inverter Section with the AC input voltage fed at the AC Input Terminals marked "GRID" (4,5,6 in Fig 2.3). 2 programming options are available for this parameter: (i) *Option "0= Fine"* (Default option) – see Section 4.5.2.8(a) below and (ii) *Option "1= Coarse"* – see Section 4.5.2.8(b) below.

When EVO™ is operating in Inverting Mode (*there is no AC input*), its output frequency will be equal to the frequency that has been selected by the programming parameter "DEFAULT FREQ" i.e. 60Hz (Default) or 50Hz (See TABLE 4.4 and Section 4.5.2.1). When AC input is made available at AC Input Terminals marked "GRID" (4,5,6 in Fig 2.3), it is first monitored for 2 sec. If it is within the programmed values of (i) frequency limits (TABLE 4.4), (ii) low voltage limits (TABLE 4.5) and (iii) high voltage limits (TABLE 4.6), synchronization process is initiated to synchronize the frequency and phase of the Inverter Section with the incoming AC input voltage. Details are given below:

a) Parameter SYNC GRID set at Option "0= Fine" (Default)

This is the "*Default Setting*". This setting is applicable when Grid / Inverter Generator is connected to AC Input Terminals marked "GRID" (4,5,6 in Fig 2.3). Synchronization control logic used in this option is suitable for more stable frequency output of Grid / Inverter Generator. Under this option, the frequency and phase of the Inverter Section are synchronized with the Grid as follows:

- i. First, the frequency of the Inverter Section is tracked in steps of 0.1Hz per cycle and made equal to the frequency of the Grid / Inverter Generator input.
- ii. Then, the phase of the Inverter voltage relative to the Grid voltage is tracked by 1° per cycle. When the phase of the Inverter voltage is within $\pm 3.5^\circ$ of the input voltage waveform, the Transfer Relay is activated to transfer the AC load from the Grid / Inverter Generator to the Inverter Section at zero crossing of the voltage waveform.

b) Parameter SYNC GRID set at Option 1= Coarse

This setting is selected if a Generator is connected to AC Input Terminals marked "GRID" (4,5,6 in Fig 2.3). As compared to very stable frequency of Grid / Inverter Generator, the frequency of a Generator may vary considerably depending upon the performance of its Speed Governor that compensates for the drop in RPM / frequency when electrical load is switched on / increased or, rise in RPM / frequency when electrical load is decreased /switched off. Hence, if synchronization sensitivity set is at "0= Fine" as in Section 4.5.2.8(a) above, it may take very long for the Inverter Section to synchronize with the Generator or, may not synchronize at all. Under this option, the frequency and phase of the Inverter Section are synchronized with the Generator

differently as follows:

- i. First, the frequency of the Inverter Section is NOT tracked at 0.1Hz per cycle as in Option "0= Fine" [See Section 4.5.2.8(a) above] but is made equal to the Generator frequency at zero crossing of the Inverter voltage.
- ii. Then, the phase of the Inverter voltage relative to the phase of the Generator voltage is tracked by 1° per cycle. When the phase of the Inverter Section is within $\pm 10.5^\circ$ of the Generator input voltage waveform, the Transfer Relay is activated to transfer the AC load from the Generator to the Inverter Section at zero crossing of the voltage waveform.

4.5.2.8.1 Programming Steps for Parameter "SYNC GRID"

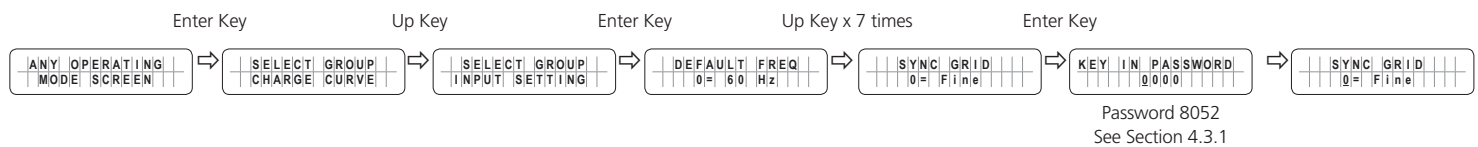

4.5.2.9 SYNC GEN (Table 4.4, Parameter Setup Screen No.9)

In EVO™, the frequency and phase of the Inverter Section are always kept synchronized with the AC input source connected to terminals marked "GEN" (7,8,9 in Fig 2.3). This facilitates faster and safer transfer of power between the Inverter Section and the AC input source. For supplementary details on synchronized transfer of AC power, please refer to Sections 4.5.4 to 4.5.7 of the Owner's Manual for EVO-2212/3012/2224/4024.

Parameter "SYNC GEN" is used to program the desired *sensitivity* of frequency and phase synchronization of the Inverter Section with the AC input voltage fed at the AC Input Terminals marked "GEN" (7,8,9 in Fig 2.3). 2 programming options are available for this parameter: (i) Option "1= Coarse" (Default option) – see Section 4.5.2.9(a) below and (ii) "Option 0= Fine" – see Section 4.5.2.9(b) below

When EVO™ is operating in Inverting Mode (*there is no AC input*), its output frequency will be equal to the frequency that has been selected by the programming parameter "DEFAULT FREQ" i.e. 60Hz (Default) or 50Hz (See TABLE 4.4 and Section 4.5.2.1). When AC input is made available at AC Input Terminals marked "GEN" (7, 8, 9 in Fig 2.3), it is first monitored for 2 sec. If it is within the programmed values of (i) frequency limits (TABLE 4.4), (ii) low voltage limits (TABLE 4.5) and (iii) high voltage limits (TABLE 4.6), synchronization process is initiated to synchronize the frequency and phase of the Inverter Section with the incoming AC input voltage. Details are given below:

a) Parameter SYNC GEN set at Option 1= Coarse (Default)

This is the "*Default Setting*". This setting is applicable when a Generator is connected to AC Input Terminals marked "GEN" (7,8,9 in Fig 2.3). As compared to very stable frequency of Grid / Inverter Generator, the frequency of a Generator may vary considerably depending upon the performance of its Speed Governor that compensates for the drop in RPM / frequency when electrical load is switched on / increased or, rise in RPM / frequency when electrical load is decreased / switched off. Hence, if synchronization sensitivity is set at "0= Fine" as in Section 4.5.2.9 (b) below, it may take very long for the Inverter Section to synchronize with the Generator or, may not synchronize at all. Under this option, the frequency and phase of the Inverter Section are synchronized with the Generator *differently* as follows:

- i. First, the frequency of the Inverter Section is NOT tracked at 0.1Hz per cycle as in Option "0= Fine" [See Section 4.5.2.9(b) below] but is made equal to the Generator frequency at zero crossing of the

Inverter voltage.

- ii. Then, the phase of the Inverter voltage relative to the Generator voltage is tracked by 1° per cycle. When the phase of the Inverter Section is within $\pm 10.5^\circ$ of the Generator input voltage waveform, the Transfer Relay is activated to transfer the AC load from the Generator to the Inverter Section at zero crossing of the voltage waveform

b) Parameter SYNC GEN set at Option "0= Fine"

This setting is selected if *Grid / Inverter Generator* is connected to AC Input Terminals marked "GEN" (7,8,9 in Fig 2.3). Synchronization control logic used in this option is suitable for more stable frequency output of Grid / Inverter Generator. Under this option, the frequency and phase of the Inverter Section are synchronized with the Grid as follows:

- i. First, the frequency of the Inverter Section is tracked in steps of 0.1Hz per cycle and made equal to the frequency of the Grid / Inverter Generator input.
- i. Then, the phase of the Inverter voltage relative to the phase of the Grid / Inverter Generator voltage is tracked by 1° per cycle. When the phase of the Inverter voltage is within $\pm 3.5^\circ$ of the input voltage waveform, the Transfer Relay is activated to transfer the AC load from the Grid / Inverter Generator to the Inverter Section at zero crossing of the voltage waveform.

4.5.2.9.1 Programming Steps for Parameter "SYNC GEN"

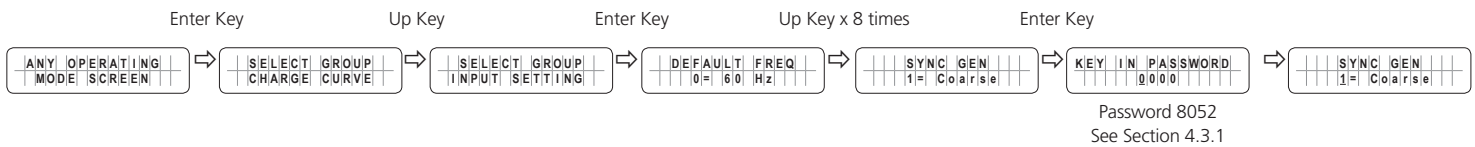

4.5.2.10 INPUT OC PROTECT (Table 4.4, Parameter Setup Screen No.10)

If the net AC input current is 1A more than the value of GRID MAX CURRENT (See Section 4.5.2.2) or GEN MAX CURRENT (See Section 4.5.2.3) for 1 sec, the AC side charging current is clawed back to ensure that GRID MAX CURRENT / GEN MAX CURRENT value is not exceeded. If the value of pass through load current increases to a value of 1A more than the programmed value of GRID MAX CURRENT / GEN MAX CURRENT for 5 sec, input over current protection will be activated based on the following 2 options provided through parameter **INPUT OC PROTECT**:

- a)

INPUT OC PROTECT
0=INV mode

 (This is the Default setting)
 - o If the AC input current is 1A more than the programmed value of GRID MAX CURRENT / GEN MAX CURRENT for more than 5 sec, the unit will switch over to Inverter Mode to ensure that AC power to the load is maintained.
 - o If the load reduces to 1A less than the programmed value of GRID MAX CURRENT / GEN MAX CURRENT for 5 sec, switch back to Charging Mode

- b)

INPUT OC PROTECT
1=Shutdown

 - o If the AC input current is 1A more than the programmed value of GRID MAX CURRENT / GEN MAX CURRENT for more than 5 sec, Fault Mode will be activated:
 - There will be no AC output because the Transfer Relay will be de-energized, charging will be stopped and PWM drive to the Inverter Section will be switched off
 - Fault message "Input over current" will be displayed on the LCD screen, Green LED marked "Status" will be switched off and Red LED marked "Fault" will be switched on.
 - o The unit will be latched in OFF condition and will require manual reset by powering off the unit, waiting for 1 min and then, powering on again

4.5.2.10.1 Programming Steps for Parameter "OC PROTECT"

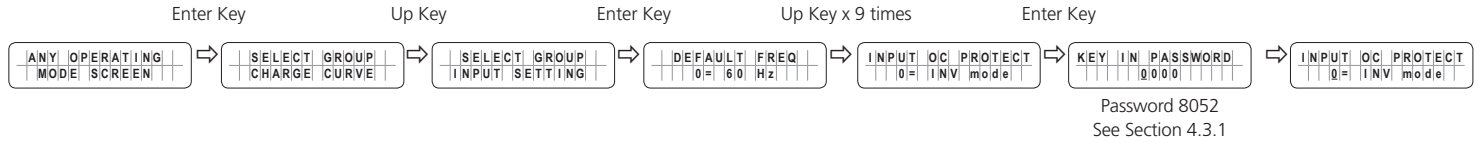

4.5.2.11 INPUT RECOVERY (Table 4.4, Parameter Setup Screen No.11)

This parameter determines how EVO™ will recover when AC input is made available while in “Battery low voltage!” or “Battery ultra low voltage!” fault conditions (Section 7, Table 7.1, Srl.2). The following 2 options are available under this parameter:

- Option “0=Buffered” (This is the default option)
- Option “1=Direct”

When the EVO™ is in “Battery low voltage!” condition (Section 7, Table 7.1, Srl.1) or in “Battery ultra low voltage!” condition (Section 7, Table 7.1, Srl.2) and if AC input is made available before expiry of time set by parameter “LV CUT OFF TIME” (Section 4.4.2.11), the “Battery low voltage!” / “Battery ultra low voltage!” fault conditions will be cleared and EVO Inverter Charger will recover based on the following 2 options:

- Option 0=Buffered (Default):** Under this option, the unit will initially start in “Inverting Mode”, synchronize with the AC input and then transfer to “Charging Mode”. However, if a user programs the value of “BATTERY LOW VOLTAGE” very close to the “Battery ultra low voltage!” fault threshold of 9V for 1 ms for EVO-2212 / 3012 or 18V for 1 ms for EVO-2224 / 4024 (Section 7, Table 7.1, Srl.2), a larger load / larger starting surge on the inverter may drag the battery voltage to 9V / 18V or below for 1 ms and trigger “Battery ultra low voltage!” fault. Under this condition, the user may change to **Option 1=Direct**
- Option 1=Direct:** Under this option, the unit will directly start in “Charging Mode”

4.5.2.11.1 Programming Steps for Parameter "INPUT RECOVERY"

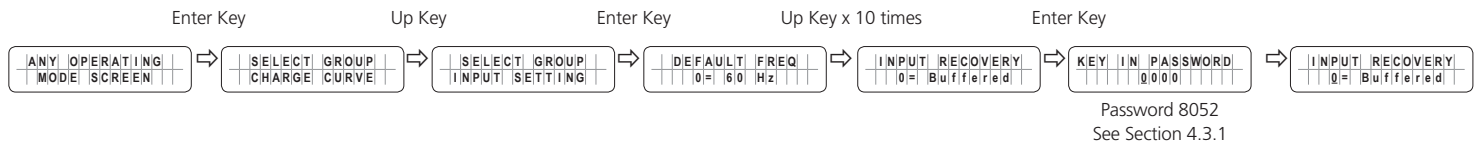

4.6 GROUP 3 PARAMETER SET UP: INPUT LOW LIMIT

4.6.1 Programming Ranges and Default Values of Parameters Under Group 3 – INPUT LOW LIMIT

Table 4.5 gives details of programming ranges and default values of parameters under Parameter Group 3 - INPUT LOW LIMIT. Refer to Fig 4.1 under Section 4.1 for Menu Map for navigating through various parameters under this Group 3.

TABLE 4.5 GROUP 3 PARAMETER SET UP: INPUT LOW LIMIT									
Parameter Setup Screen No. for Parameter Group No.3 <i>(Fig 4.1)</i>	Parameter	Setting range				Default value			
		EVO-2212	EVO-3012	EVO-2224	EVO-4024	EVO-2212	EVO-3012	EVO-2224	EVO-4024
1	RESET VOLTAGE	60.0 – 120.0V				105.0V			
2	CUT OFF VOLT 1	60.0 – 120.0V				100.0V			
3	DETECT TIME 1	0 – 2000 cycles				300 cycles			
4	CUT OFF VOLT 2	60.0 – 120.0V				95.0V			
5	DETECT TIME 2	0 – 2000 cycles				15 cycles			
6	CUT OFF VOLT 3	60.0 – 120.0V				90.0V			
7	DETECT TIME 3	0 – 2000 cycles				1 cycle			

4.6.2 Description of Parameters Under Group 3 – INPUT LOW LIMIT



INFO

The values shown under various screens are the Default Values for EVO-2212

4.6.2.1 RESET VOLTAGE *(Table 4.5, Parameter Setup Screen No.1)*

This is the reset voltage at which the unit will revert to "Charging Mode" after it has switched over to "Inverting Mode" due to input voltage falling to "CUT-OFF VOLT 1 *(Section 4.6.2.2)*, or CUT-OFF VOLT 2 *(Section 4.6.2.4)*, or CUT-OFF VOLT3" *(Section 4.6.2.6)*.

4.6.2.1.1 Programming Steps for Parameter "RESET VOLTAGE"

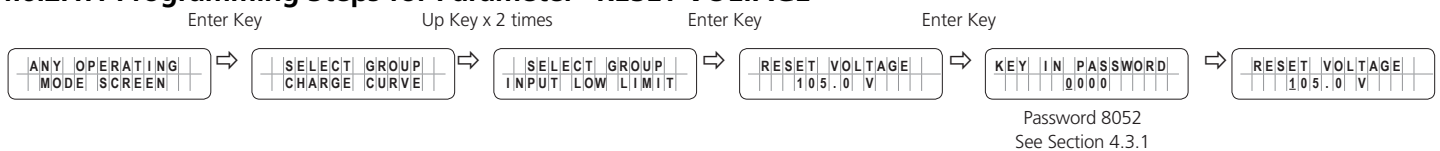

4.6.2.2 CUT OFF VOLT 1 *(Table 4.5, Parameter Setup Screen No.2)*

If during "Charging Mode", the AC input voltage falls below "CUT-OFF VOLT 1" for period > "DETECT TIME 1" *(Section 4.6.2.3)*, the EVO™ Inverter/Charger will transfer to Inverting Mode from "Charging Mode".

4.6.2.2.1 Programming Steps for Parameter "CUT OFF VOLT 1"

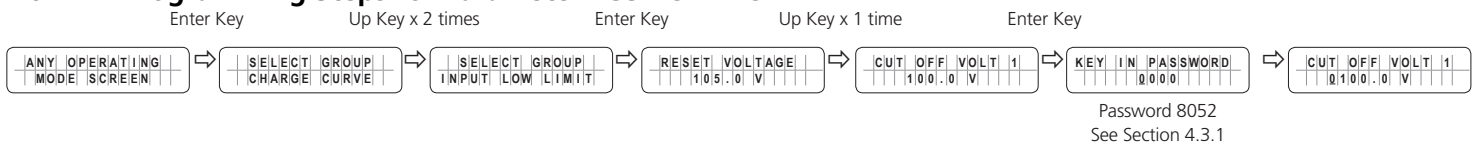

4.6.2.3 DETECT TIME 1 *(Table 4.5, Parameter Setup Screen No.3)*

This is the time limit in cycles up to which low AC input voltage "CUT-OFF VOLT 1" *(Section 4.6.2.2)* is allowed.

4.6.2.3.1 Programming Steps for Parameter "DETECT TIME 1"

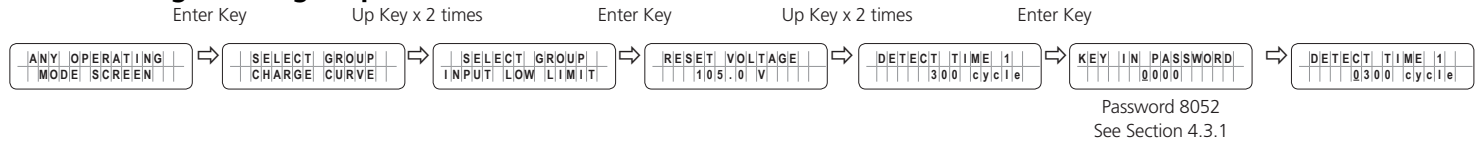

4.6.2.4 CUT OFF VOLT 2 *(Table 4.5, Parameter Setup Screen No.4)*

If during "Charging Mode", the AC input voltage falls below "CUT-OFF VOLT 2" for period > "DETECT TIME 2" *(Section 4.6.2.5)*, the EVO™ Inverter/Charger will transfer to "Inverting Mode".

4.6.2.4.1 Programming Steps for Parameter "CUT OFF VOLT 2"

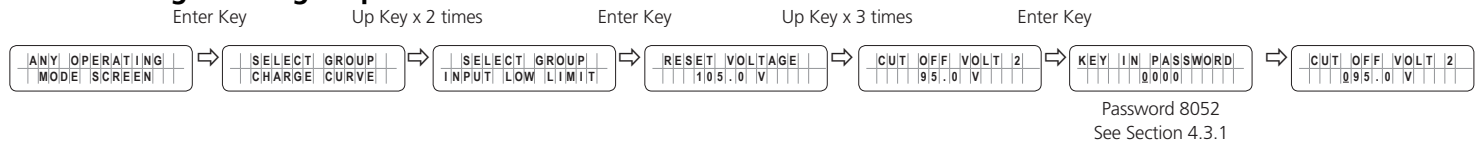

4.6.2.5 DETECT TIME 2 *(Table 4.5, Parameter Setup Screen No.5)*

This is the time limit in cycles up to which low AC input voltage "CUT-OFF VOLT 2" *(Section 4.6.2.4)* is allowed.

4.6.2.5.1 Programming Steps for Parameter "DETECT TIME 2"

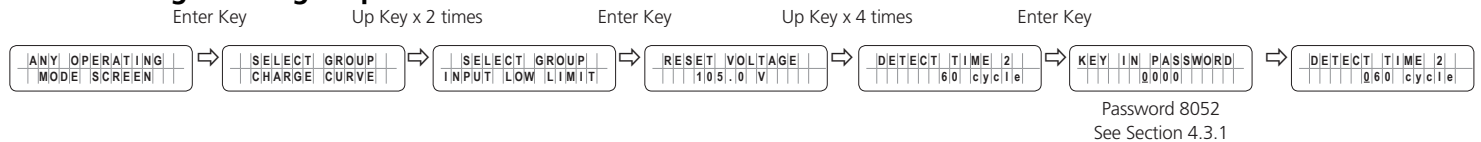

4.6.2.6 CUT OFF VOLT 3 *(Table 4.5, Parameter Setup Screen No.6)*

If during "Charging Mode", the AC input voltage falls below "CUT-OFF VOLT 3" for period > "DETECT TIME 3" *(Section 4.6.2.7)*, the EVO™ Inverter/Charger will transfer to "Inverting Mode".

4.6.2.6.1 Programming Steps for Parameter "CUT OFF VOLT 3"

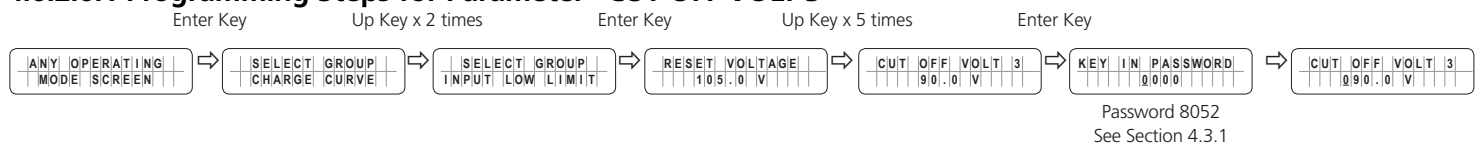

4.6.2.7 DETECT TIME 3 *(Table 4.5, Parameter Setup Screen No.7)*

This is the time limit in cycles up to which low AC input voltage "CUT-OFF VOLT 3" *(Section 4.6.2.6)* is allowed.

4.6.2.7.1 Programming Steps for Parameter "DETECT TIME 3"

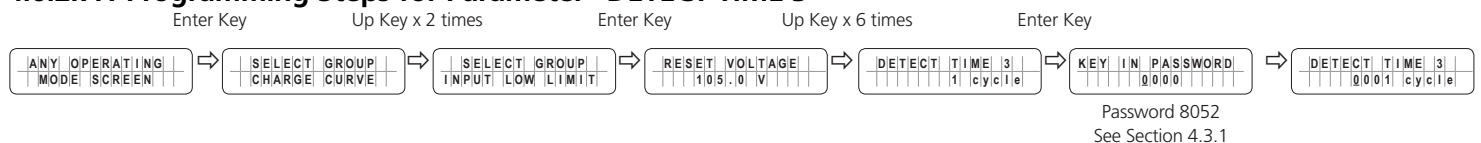

4.7 GROUP 4 PARAMETER SET UP: INPUT HIGH LIMIT

4.7.1 Programming Ranges and Default/ Factory Preset Values of Parameters Under Group 4 – INPUT HIGH LIMIT

Table 4.6 gives details of programming ranges and default values of parameters under Parameter Group 4 - INPUT HIGH LIMIT. Refer to Fig 4.1 under Section 4.1 for Menu Map for navigating through various parameters under this Group 4.

TABLE 4.6 GROUP 4 PARAMETER SET UP: INPUT HIGH LIMIT									
Parameter Setup Screen No. for Parameter Group No.4 (Fig 4.1)	Parameter	Setting range				Default value			
		EVO-2212	EVO-3012	EVO-2224	EVO-4024	EVO-2212	EVO-3012	EVO-2224	EVO-4024
1	RESET VOLTAGE	120.0 – 150.0V				125.0V			
2	CUT OFF VOLT 1	120.0 – 150.0V				135.0V			
3	DETECT TIME 1	0 – 2000 cycles				60 cycles			
4	CUT OFF VOLT 2	120.0 – 150.0V				140.0V			
5	DETECT TIME 2	0 – 2000 cycles				15 cycles			
6	CUT OFF VOLT 3	120.0 – 150.0V				145.0V			
7	DETECT TIME 3	0 – 2000 cycles				1 cycle			

4.7.2 Description of Parameters Under Group 4 – INPUT HIGH LIMIT



INFO

The values shown under various screens are the Default Values for EVO-2212

4.7.2.1 RESET VOLTAGE (Table 4.6, Parameter Setup Screen No.1)

This is the reset voltage at which the unit will revert to "Charging Mode" after it has switched over to "Inverting Mode" due to input voltage falling to "CUT-OFF VOLT 1 (Section 4.7.2.2), or CUT-OFF VOLT 2 (Section 4.7.2.4), or CUT-OFF VOLT3" (Section 4.7.2.6).

4.7.2.1.1 Programming Steps for Parameter "RESET VOLTAGE"

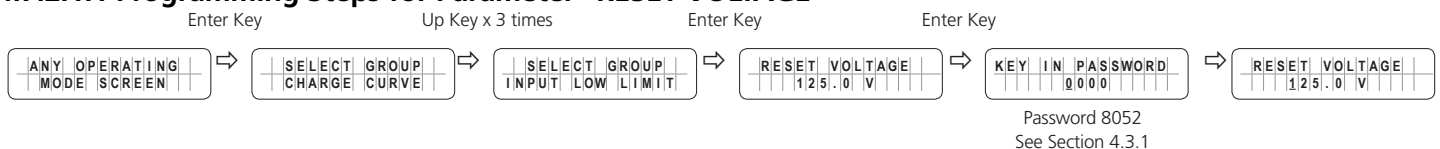

4.7.2.2 CUT OFF VOLT 1 (Table 4.6, Parameter Setup Screen No.2)

If during "Charging Mode", the AC input voltage falls below "CUT-OFF VOLT 1" for period > "DETECT TIME 1" (Section 4.7.2.3), the EVO™ Inverter/Charger will transfer to Inverting Mode.

4.7.2.2.1 Programming Steps for Parameter "CUT OFF VOLT 1"

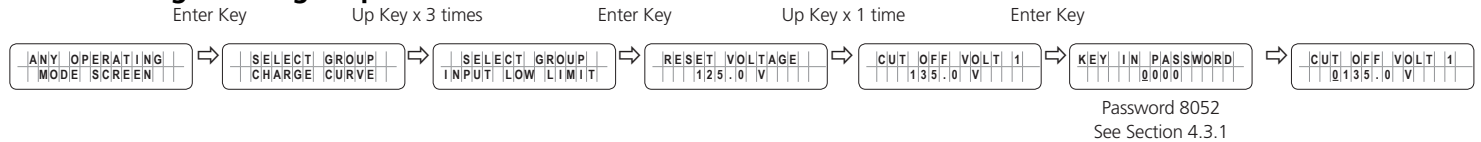

4.7.2.3 DETECT TIME 1 (Table 4.6, Parameter Setup Screen No.3)

This is the time limit in cycles up to which low AC input voltage "CUT-OFF VOLT 1" (Section 4.7.2.2) is allowed.

4.7.2.3.1 Programming Steps for Parameter "DETECT TIME 1"

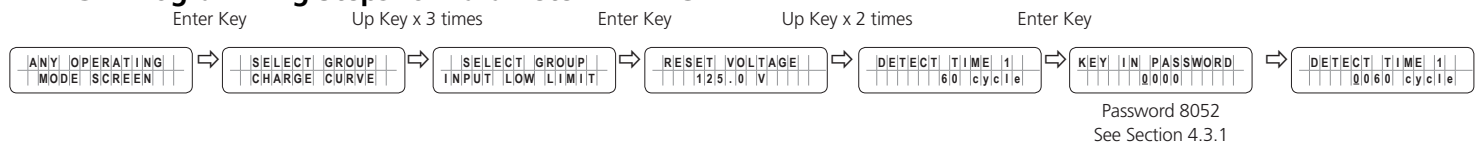

4.7.2.4 CUT OFF VOLT 2 (Table 4.6, Parameter Setup Screen No.4)

If during "Charging Mode", the AC input voltage falls below "CUT-OFF VOLT 2" for period > "DETECT TIME 2" (Section 4.7.2.5), the EVO™ Inverter/Charger will transfer to "Inverting Mode".

4.7.2.4.1 Programming Steps for Parameter "CUT OFF VOLT 2"

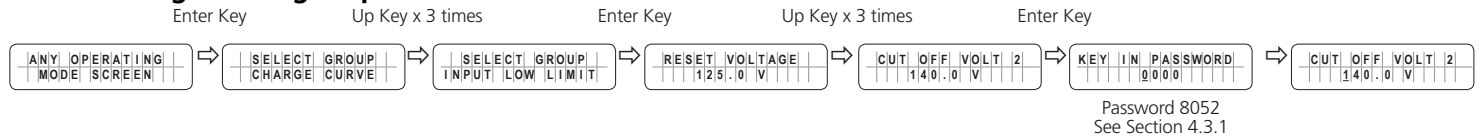

4.7.2.5 DETECT TIME 2 (Table 4.6, Parameter Setup Screen No.5)

This is the time limit in cycles up to which low AC input voltage "CUT-OFF VOLT 2" (Section 4.7.2.4) is allowed.

4.7.2.5.1 Programming Steps for Parameter "DETECT TIME 2"

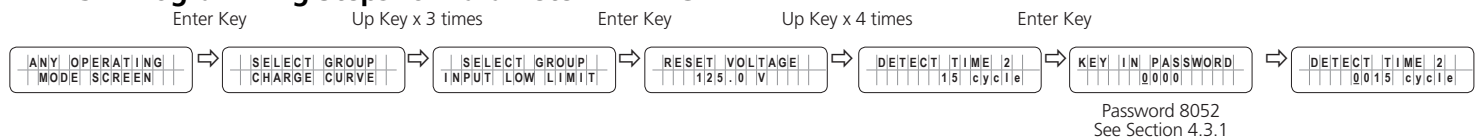

4.7.2.6 CUT OFF VOLT 3 (Table 4.6, Parameter Setup Screen No.6)

If during "Charging Mode", the AC input voltage falls below "CUT-OFF VOLT 3" for period > "DETECT TIME 3" (Section 4.7.2.7), the EVO™ Inverter/Charger will transfer to "Inverting Mode".

4.7.2.6.1 Programming Steps for Parameter "CUT OFF VOLT 3"

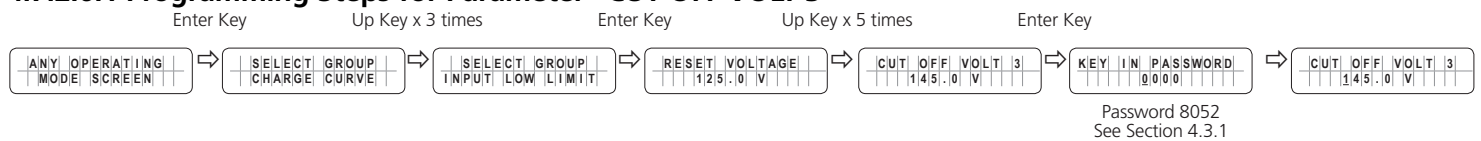

4.7.2.7 DETECT TIME 3 (Table 4.6, Parameter Setup Screen No.7)

This is the time limit in cycles up to which low AC input voltage "CUT-OFF VOLT 3" (Section 4.7.2.6) is allowed.

4.7.2.7.1 Programming Steps for Parameter "DETECT TIME 3"

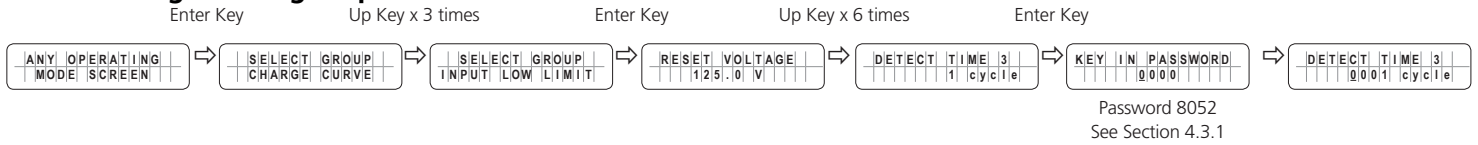

4.8 GROUP 5 PARAMETER SET UP: OTHER FUNCTIONS

4.8.1 Programming Ranges and Default/ Factory Preset Values of Parameters Under Group 5 – OTHER FUNCTION

Table 4.7 gives details of programming ranges and default values of parameters under Parameter Group 5 - OTHER FUNCTION. *Refer to Fig 4.2 under Section 4.1 for Menu Map for navigating through various parameters under this Group 5.*

TABLE 4.7 GROUP 5 PARAMETER SET UP: OTHER FUNCTIONS									
Parameter Setup Screen No. for Parameter Group No.5 (Fig 4.2)	Parameter	Setting range				Default value			
		EVO-2212	EVO-3012	EVO-2224	EVO-4024	EVO-2212	EVO-3012	EVO-2224	EVO-4024
1	POWER SAVING	1 = Enable 0 = Disable				0 = Disable			
2	ENTER POINT	4 – 50W				6W	8W	6W	8W
3	WAKE UP POINT	5 – 50W				7W	10W	7W	10W
4	REMOTE SWITCH	0 = Button Type 1 = Switch Type				Button type			
5	RELAY FUNCTION	0 = Charge/Other 1 = Normal/Fault 2 = Generator 0 3 = Generator 1 4 = Generator 2				2 = Generator 0			
6	COMM ID	1 – 255				1			
7	BUZZER	1 = ON 0 = OFF				1 = ON			
8	DISCHARGE BEEP	1 = ON 0 = OFF				0 = OFF			
9	DEFAULT RESET	0 = No 1 = Yes				0 = No			
10	DATALOG DISABLE DATALOG TIME	0 = Disable, 1 = 1 sec, 2 = 10 sec, 3 = 30 sec 4 = 1 min, 5 = 5 min, 6 = 10 min				1 = 1 sec			
11	PARAMETER SAVE	0 = No 1 = Yes				0 = No			
12	TEMP UNIT	0 = °C 1 = °F				0 = °C			
13	PASSWORD DISABLE	0 = No 1 = Yes				0 = No			

4.8.2 Description of Parameters Under Group 5 – OTHER FUNCTION



INFO

The values shown under various screens are the Default Values for EVO-2212

4.8.2.1 POWER SAVING (Table 4.7, Parameter Setup Screen No.1)



INFO

For more information on use and application of Power Save Functions, *please refer to Sections 4.8.3 & 4.8.4 in the attached "Evolution Series Inverter/ Charger Owner's Manual for Models EVO-2212/3012/2224/4024."*

Parameter "POWER SAVING" is used to enable or disable Power Saving Mode when in "Inverting Mode".

4.8.2.1.1 Programming Steps for Parameter "POWER SAVING"

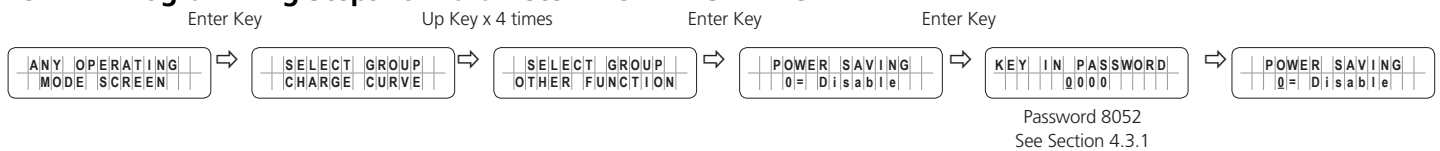

4.8.2.2 ENTER POINT (Table 4.7, Parameter Setup Screen No.2)

If the value of power drawn by AC load falls to the "ENTER POINT" value for 5 sec, the unit will enter "Power Save Mode" (Section 4.8.2.1).

4.8.2.2.1 Programming Steps for Parameter "ENTER POINT"

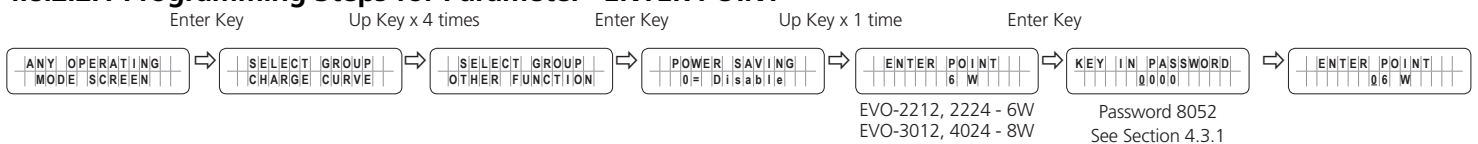

4.8.2.3 WAKE UP POINT (Table 4.7, Parameter Setup Screen No.3)

If the unit is in "Power Save Mode" (Section 4.8.2.1) and the value of the AC power of the load rises to "WAKE UP POINT", the unit will quit "Power Save Mode" and will start operating in full voltage "Inverting Mode".

4.8.2.3.1 Programming Steps for Parameter "WAKE UP POINT"

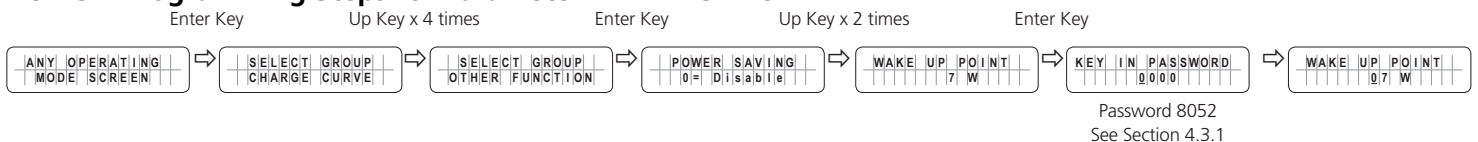

4.8.2.4 REMOTE SWITCH (Table 4.7, Parameter Setup Screen No.4)

This parameter is used when ON/OFF control of EVO™ Inverter/Charger is desired through external 12 VDC signal fed to terminals marked "Remote ON/OFF" on the Front Panel of EVO™ Inverter/Charger (15, Fig 2.1 in the attached Owner's Manual for EVO-2212/3012/2224/4024).

On/Off Logic Diagram is shown in Fig 4.4 below:

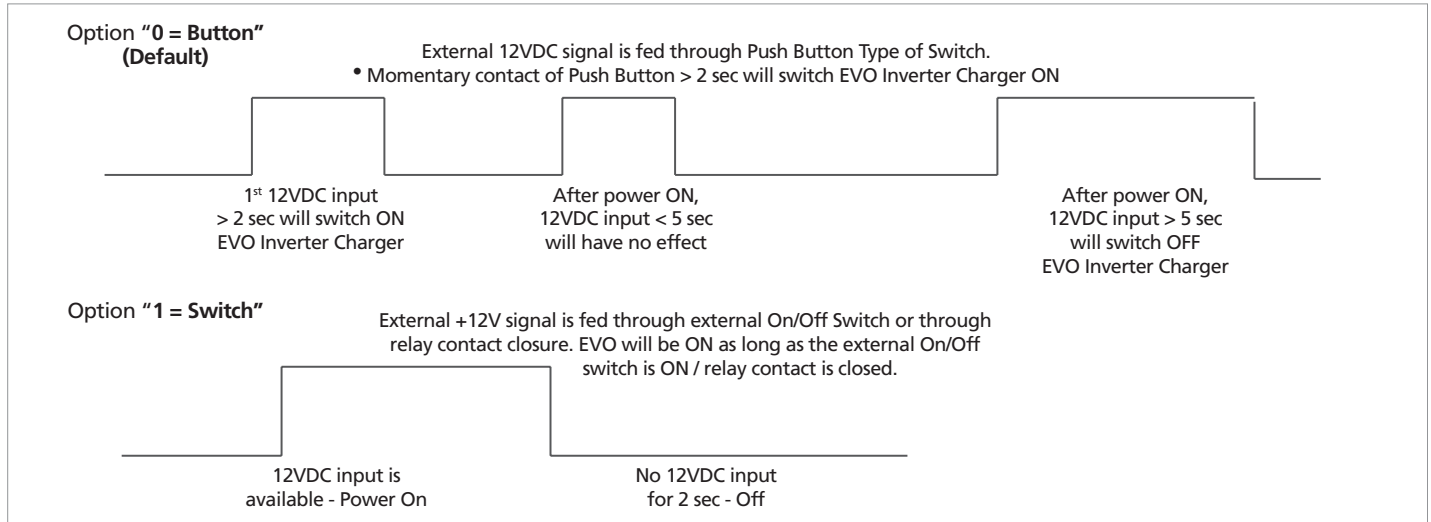

Fig 4.4. On/Off Logic Diagram for Options under Parameter "REMOTE SWITCH"



CAUTION!

On/Off Logic shown in Fig 4.4 also controls the operation of the On/Off Button on the front panel of EVO™ Inverter/Charger (11, Fig 2.1 in the attached Owner's Manual for EVO-2212/3012/2224/4024). The Default Setting is "Button Type". If parameter "REMOTE SWITCH" is set to option "1=Switch", the normal On/Off operation of EVO using the front panel On/Off Button (Section 3.2) will be disrupted i.e. EVO will remain on as long as the On/Off Button is kept pressed and will switch Off when the Button is released (See logic diagram for Option "1=Switch" in Fig 4.4)



ATTENTION!

Logique On / Off montré dans la figure 4,4 contrôle également le fonctionnement du bouton ON/OFF sur le panneau d'avant de l'onduleur chargeur de l' EVO™ (11 , figure 2,1 dans le manuel d'utilisation ci-joint pour EVO-2212/3012/2224/4024). Le réglage par défaut est « Button Type ». Si le paramètre "REMOTE SWITCH" ; est définie à l'option « 1 =Switch, le fonctionnement marche/arrêt normal d'EVO à l'aide du panneau avant sur le bouton marche/arrêt (Section 3.2) sera perturbé, c.-à-EVO reste allumé aussi longtemps que le bouton marche/arrêt est enfoncé et s'éteint lorsque le bouton est relâché (voir schéma logique pour l'option « 1 =Switch" ; dans la figure 4.4)

4.8.2.4.1 Programming Steps for Parameter "REMOTE SWITCH"

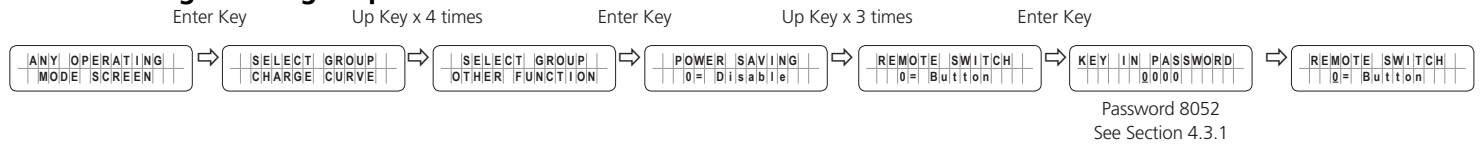

4.8.2.5 RELAY FUNCTION (Table 4.7, Parameter Setup Screen No.5)

A Single Pole Double Throw (SPDT) Status Relay with 3 contacts (Contact Rating: 3A ; 125 VAC / 30 VDC) has been provided that is used for (i) signaling of operational status [Options 0 and 1 - see Section 4.8.2.5.1(a)] and (ii) providing contact closure / opening for automatic starting and stopping of generator through appropriate optional Generator Auto Start / Stop Control Module [Options 2, 3 and 4 - see Section 4.8.2.5.2(a) to (c)]. The 3 contacts of the Status Relay are connected to 3 terminals of Terminal Block (14, Fig 2.1 in the attached Owner's Manual for EVO-2212/3012/2224/4024) on the front panel. The contacts are marked "NO" (Normally Open), "Common" and "NC" (Normally Closed). When the Status Relay is OFF (de-energized), contacts marked "Common" and "NO" will be in open condition and contacts marked "Common" and "NC" will be in closed condition. When the Status Relay is ON (energized), contacts marked "Common" and "NO" will close and contacts marked "Common" and "NC" will open.

Diagram showing steps for programming the "RELAY FUNCTION" (Table 4.7, Parameter Setup Screen No.5) and details of 5 different associated Options 0 to 4 are provided in the succeeding paragraphs

4.8.2.5.1 Signaling of Operational States (Options 0 and 1)

- a) **Option "0 = Charger/Other":** When the EVO™ Inverter/Charger is in "Charging" Mode, the Status Relay will be OFF (de-energized) [(i) "Common" and "NO" contacts will be in open condition and (ii) "Common" and "NC" contacts will be in closed condition]. In "Other" operating modes i.e. in "Inverting", "Power Save" or in "Standby" Modes, the Status Relay will be ON (energized) [(i) Common and "NO" contacts will close and (ii) "Common" and "NC" contacts will open]
- b) **Option "1= Normal/Fault":** When in "Normal" operational state i.e. when not in Fault Mode, the Status Relay will be OFF (de-energized) [(i) "Common" and "NO" contacts will be in open condition and (ii) "Common" and "NC" contacts will be in closed condition]. When the EVO™ Inverter/Charger is in "Fault" mode (Section 7, Table 7.1), the Status Relay will be ON (energized) [(i) Common and "NO" contacts will close and (ii) "Common" and "NC" contacts will open].



INFO

A 12V, 100 mA capacity DC source has been provided in the main EVO unit (16 in Fig 2.1 of the attached Owners Manual for EVO-2212/ 3012/ 2224/ 4024). This 12V DC source may be used to drive 12V rated signalling device through the contacts of the Status Relay for the above 2 options (Options 0 & 1)

4.8.2.5.2 Automatic Starting and Stopping of Generator (Options 2, 3 and 4)

The Normally Open "NO" and "Common" contacts of Status Relay (14, Fig 2.1 in the attached Owner's Manual for EVO-2212/3012/2224/4024) can be used to also automatically start and stop generator through appropriate external Generator Auto Start / Stop Module. 3 options [Options 2, 3 and 4 - see Sections 4.8.2.5.2.1 to 4.8.2.5.2.3] are available for carrying out this function depending upon user requirements. The "Common" and "NO" terminals are wired to the optional Generator Auto Start / Stop Control Module which, in turn, is wired to the Remote Start / Stop connections on the Generator. The AC output terminals of the Generator are wired to the Generator Input Terminals

on the EVO™ (7, 8, 9 in Fig 2.3 in the attached Owner's Manual for EVO-2212/3012/2224/4024). For installation details, please refer to Section 3.17 / Fig 3.14 and Section 3.18 / Fig 3.15A & B in the attached Owner's Manual for EVO-2212/3012/2224/4024.



It is recommended that "GSCM-Mini" Series of Generator Start / Stop Control Module, appropriate for the generator may be considered and ordered directly from Atkinson Electronics www.atkinsonelectronics.com

Based on the Generator Start Logic contained in one of the selected Options 2, 3 or 4 explained below (See Sections 4.8.2.5.2.1 to 4.8.2.5.2.3), the Status Relay will be switched ON (energized), its "Common" and "NO" contacts will close and the external Generator Start / Stop Control Module will initiate automatic starting of the Generator. Once the Generator has started and starts feeding AC output to EVO™ (within the programmed limits of voltage and frequency), the EVO™ will be synchronized with the Generator and once synchronization is completed, the load will be transferred instantly (within 1 ms) to the Generator at Zero Crossing of the voltage waveform for seamless transfer and for better protection of Transfer Relay contacts. The EVO™ will now operate in "Charging Mode" with the AC power from the Generator charging the batteries as well as providing power to the AC load(s).

Based on the Generator Stop Logic contained in one of the selected Options 2, 3 or 4 explained below (See Sections 4.8.2.5.2.1 to 4.8.2.5.2.3), the Status Relay will be switched OFF (de-energized), its "Common" and "NO" contacts will open and the external Generator Auto Start Control Control Module will initiate automatic stopping of the Generator. When AC output of the generator is shut down, the EVO™ will automatically transfer the AC load(s) to the "Inverter Section" within 16 ms.

Options 2, 3 and 4 of Parameter "RELAY FUNCTION" related to automatic starting and stopping of generator are explained below under Sections 4.8.2.5.2.1 to 4.8.2.5.2.3:

4.8.2.5.2.1 Option 2= Generator 0 (This is the Default Option):

This option will start the Generator at "LOW VOLT ALARM" (Section 4.4.2.8) and stop the Generator when the batteries are charged based on the charging profile selected through programming parameter "CHARGING PROFILE" (Section 4.4.2.21).

Further details are given below:

- If the battery voltage drops to "LOW VOLT ALARM" (Section 4.4.2.8) for continuous period that has been set by parameter "GS DETECT TIME" (Section 4.4.2.16), the Status Relay will be energized. "Common" and "NO" contacts of the Status Relay will close to initiate automatic starting of the Generator
- Once the generator has started and starts feeding AC output (within the programmed limits of voltage and frequency), the EVO™ will change over from "Inverting Mode" to "Charging Mode". Battery charging will be initiated as per the charging profile set through parameter "CHARGING PROFILE" (Section 4.4.2.21)
- Charging will be carried out till the batteries are charged as follows and then, the Status Relay will be de-energized to stop the generator:
 - For Parameter "CHARGING PROFILE" (Section 4.4.2.21) set for 3 Stage Charging Profile as per (i) "Option

"0 = 3 Stage Type 0", (ii) Option "1 = 3 Stage Type 1" and (iii) Option "2 = 3 Stage Type 2"

- The Status Relay will be de-energized to stop the Generator as soon as the battery bank is charged to the voltage threshold set by parameter "FLOATING VOLTAGE" ([Section 4.4.2.4](#))
- For Parameter "CHARGING PROFILE" (Section 4.4.2.21) set for 2 Stage Charging Profile as per "Option "3 = 2 Stage Type 1"
 - The Status Relay will be de-energized to stop the Generator when the battery bank is charged to voltage threshold set by parameter "ABSORP VOLTAGE" ([Section 4.4.2.2](#)) and remains at this level for time period set by parameter "ABSORP TIME" ([Section 4.4.2.19](#))
- For Parameter "CHARGING PROFILE" (Section 4.4.2.21) set for 2 Stage Charging Profile as per "Option "4 = 2 Stage Type 2"
 - The Status Relay will be de-energized to stop the Generator when the battery bank is charged to voltage threshold set by parameter "ABSORP VOLTAGE" ([Section 4.4.2.2](#)) and remains at this level for time period of 6 min
- For Parameter "CHARGING PROFILE" (Section 4.4.2.21) set for 2 Stage Charging Profile as per "Option "3 = 2 Stage Type 3"
 - The Status Relay will be de-energized to stop the Generator when the battery bank is charged to voltage threshold set by parameter "ABSORP VOLTAGE" ([Section 4.4.2.2](#)) and subsequently, the charging current drops to threshold set by parameter "ABSORP EXIT AMPS" ([Section 4.4.2.20](#))

When the Status Relay is de-energized, "Common" and "NO" contacts of the Status Relay will open to initiate automatic stopping of the Generator. When AC output voltage from the Generator switches off, the EVO will change over to "Inverting Mode".

4.8.2.5.2.2 Option 3= Generator 1

This option will start the Generator at "LOW VOLT ALARM" ([Section 4.4.2.8](#)) and stop the Generator when the batteries are charged to the desired programmed level of "RESET VOLTAGE" ([Section 4.4.2.7](#)) and stay at this desired level of voltage or higher for the desired programmed time period = "GEN OFF DELAY" ([Section 4.4.2.18](#)).

Further details are given below:

- If the battery voltage drops to "LOW VOLT ALARM" ([Section 4.4.2.8](#)) or lower for continuous period = "GS DETECT TIME" ([Section 4.4.2.16](#)), the Status Relay will be switched ON (energized). "Common" and "NO" contacts of the Status Relay will close to initiate automatic starting of the Generator
- Once the generator has started and starts feeding AC output (within the programmed limits of voltage and frequency), the EVO™ will change over from "Inverting Mode" to "Charging Mode". Battery charging will be initiated as per Charging Profile set by parameter "CHARGING PROFILE" ([Section 4.4.2.21](#)).
- When the batteries are charged to the desired voltage level set by parameter "RESET VOLTAGE" ([Section 4.4.2.7](#)) and stay at this desired level of voltage, or higher for the desired programmed time period = "GEN OFF DELAY" ([Section 4.4.2.18](#)), the Status Relay will be switched OFF (de-energized). "Common" and "NO" contacts of the Status Relay will open to initiate automatic stopping of the Generator. When AC output from the Generator switches OFF, EVO™ will change over to "Inverting Mode" (**NOTE: The State of Charge of the battery after the Status Relay has been switched OFF (de-energized) and Generator is stopped will be indeterminate.**)

4.8.2.5.2.3 Option 4= Generator 2

This option will start the Generator at "LOW VOLT ALARM" (Section 4.4.2.8) and stop the Generator after the desired programmed value of run time of the Generator = "GEN ON TIME" (Section 4.4.2.17) counted from the time the Status Relay is switched ON (energized).

Further details are given below:

- If the battery voltage drops to "LOW VOLT ALARM" (Section 4.4.2.8), or lower for continuous period = "GS DETECT TIME" (Section 4.4.2.16), the Status Relay will be switched ON (energized). "Common" and "NO" contacts of the Status Relay will close to initiate automatic starting of the Generator
- Once the generator has started and starts feeding AC output (within the programmed limits of voltage and frequency), the EVO™ will change over from "Inverting Mode" to "Charging Mode". Battery charging will be initiated as per the charging profile set by parameter "CHARGING PROFILE" (Section 4.4.2.21)
- The Status Relay will be switched OFF (de-energized) after expiry of the desired programmed Generator run time = "GEN ON TIME" (Section 4.4.2.17) counted from the time the Status Relay is switched ON (energized). "Common" and "NO" contacts of the Status Relay will open to initiate automatic stopping of the Generator. When AC output from the Generator switches OFF, EVO™ will change over to "Inverting Mode" (NOTE: The State of Charge of the battery after the Status Relay has been switched OFF (de-energized) and Generator is stopped will be indeterminate.)

4.8.2.5.3 Programming Steps for Parameter "RELAY FUNCTION"

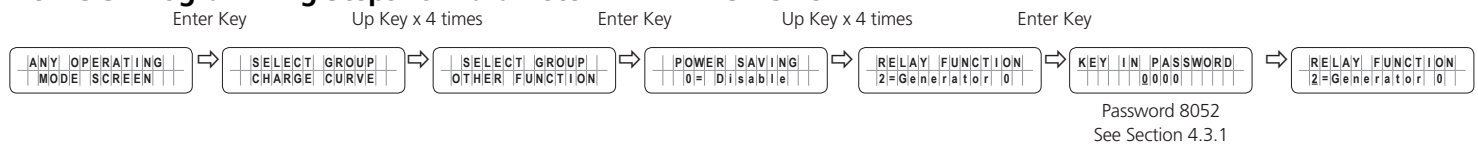

4.8.2.6 COMM ID (Table 4.7, Parameter Setup Screen No.6)

Communication ID- This sets the ID number for the COMM Port and EVO-RC Remote Control.

4.8.2.6.1 Programming Steps for Parameter "COMM ID"

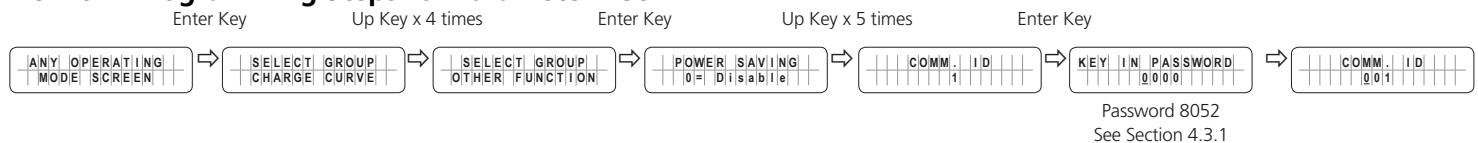

4.8.2.7 BUZZER (Table 4.7, Parameter Setup Screen No.7)

Set the buzzer ON/OFF.

4.8.2.7.1 Programming Steps for Parameter "BUZZER"

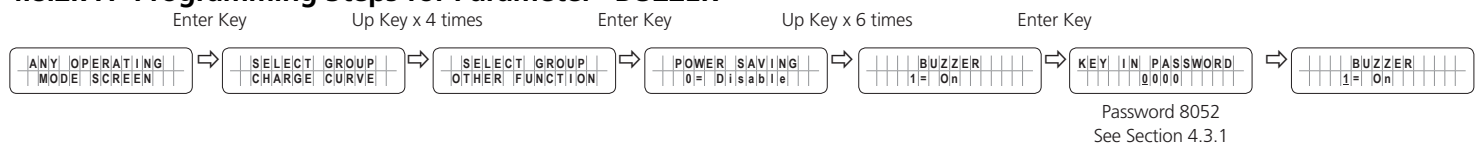

4.8.2.8 DISCHARGE BEEP *(Table 4.7, Parameter Setup Screen No.8)*

To select the buzzer ON/OFF while in "Inverting Mode".

4.8.2.8.1 Programming Steps for Parameter "DISCHARGE BEEP"

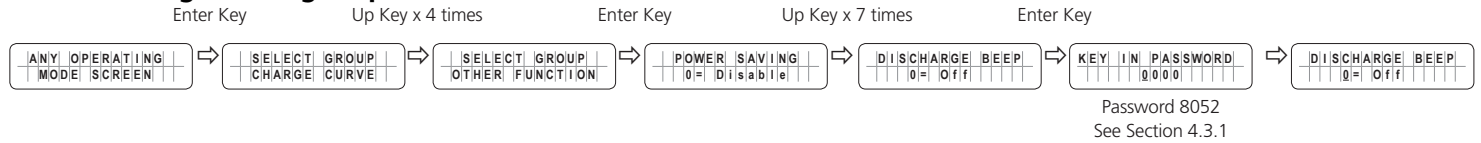

4.8.2.9 DEFAULT RESET *(Table 4.7, Parameter Setup Screen No.9)*

This is to reset all of the parameters to the Default Values.

4.8.2.9.1 Programming Steps for Parameter "DEFAULT RESET"

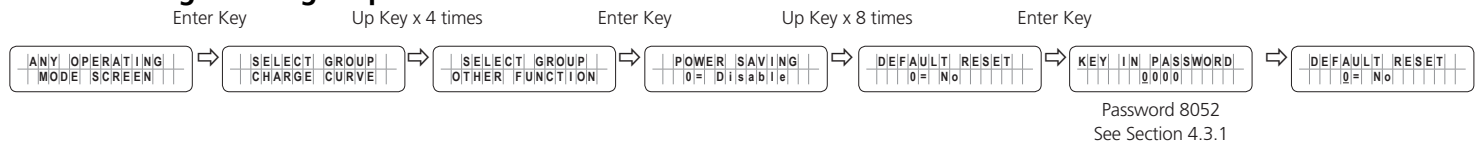

4.8.2.10 DATALOG TIME *(Table 4.7, Parameter Setup Screen No.10)*

Set the time period of the data log.

0 = Disable 1 = 1 sec 2 = 10 sec 3 = 30 sec

4 = 60 sec 5 = 5 min 6 = 10 min

4.8.2.10.1 Programming Steps for Parameter "DATALOG TIME"

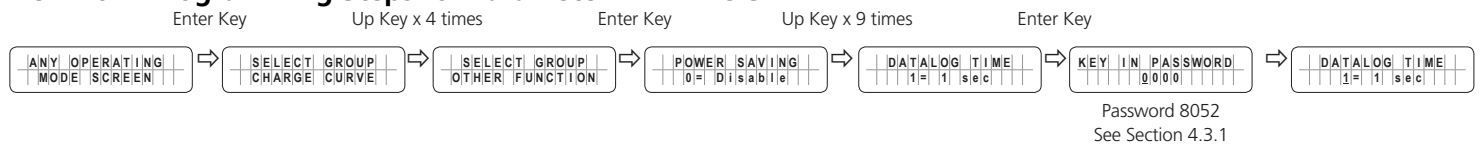

4.8.2.11 PARAMETER SAVE *(Table 4.7, Parameter Setup Screen No.11)*

Save all parameters to SD Card. (see Details at Section 5)

4.8.2.11.1 Programming Steps for Parameter "PARAMETER SAVE"

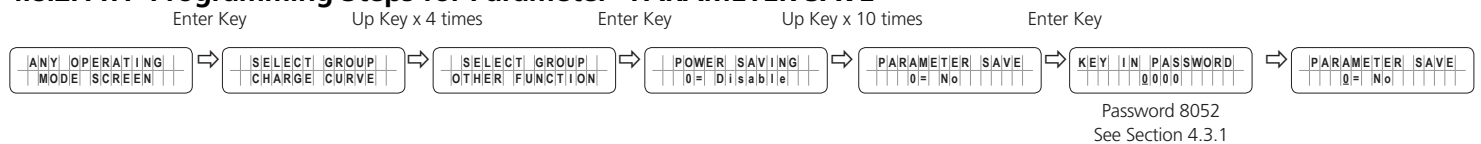

4.8.2.12 TEMP UNIT *(Table 4.7, Parameter Setup Screen No.12)*

Temperature can be displayed in °C or in °F. Default is in °C.

4.8.2.12.1 Programming Steps for Parameter "TEMP UNIT"

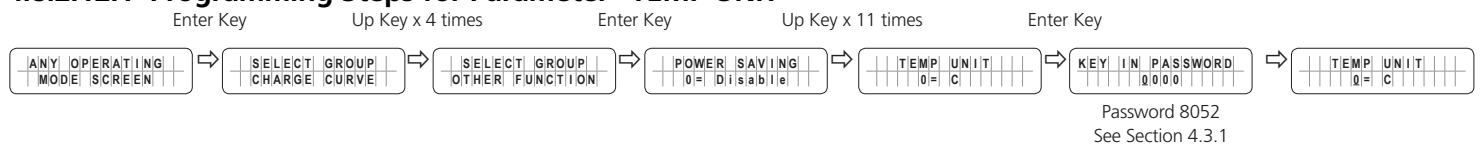

4.8.2.13 PASSWORD DISABLE *(Table 4.7, Parameter Setup Screen No.13)*

This parameter allows to disable/ enable Password (8052) to change the value of programmable parameter. Use of Password is recommended because it prevents accidental/ un-intentional change of parameter setting. Default is enabled (PASSWORD DISABLE set at option "0=No")

4.8.2.13.1 Programming Steps for Parameter "PASSWORD DISABLE"

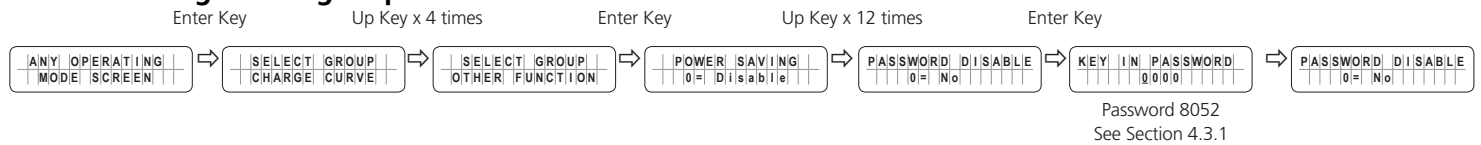

4.9 GROUP 6 PARAMETER SETUP: TIME SETTING *(Section 4.1, Fig 4.2, Group 6)*

Please refer to Parameter "TIME SETTING" under Group 6 at Fig 4.2. Set up details are given below. The Date and Time Format is Year/Month/Day Hour:Minute (24 hour clock):

4.9.1 Programming Steps for Parameter "TIME SETTING"

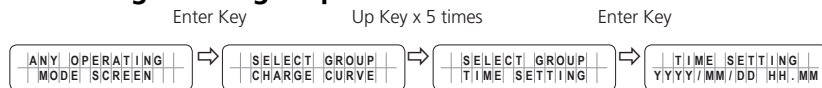

INFO

- Time can be programmed from Year 2000 to 2099 only.
- Month can be programmed from 01 to 12 only.
- Day can be programmed from 01 to 31 only.
- Hour can be programmed from 00 to 24 only.
- Minute can be programmed from 00 to 60 only.
- If the numbers Entered for Month, Day, Hour and Minute are not within the above ranges, message "OUT OF RANGE!" will be displayed and the display screen will go back to the previously set time. Setting procedure will have to be re-started.

4.10 GROUP 7 PARAMETER SETUP: STOP SD CARD *(Section 4.1, Fig 4.2, Group 7)*

Please refer to Parameter "STOP SD CARD" under Group 7 at Fig 4.2. Please note that this set up is displayed / accessible only when SD Card is inserted in the SD Card Slot (9, Fig 1.1a). Set up details are given below:

Once SD Card is being used, it should be removed/ejected only after the operation of the Card has been stopped as shown below and message "Please remove SD Card" appears. If the SD card is not removed within 30 sec, it will reset. After the card is removed, it reverts to the original operating screen.

4.10.1 Programming Steps for Parameter "STOP SD CARD"

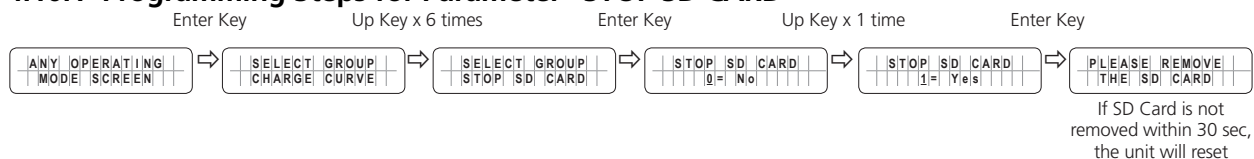

5.1 SD CARD GENERAL INFORMATION

SD Card slot has been provided for using an SD card for (i) data logging and (ii) saving programmed parameters. SD card supports FAT16/FAT32 format up to 16GB in size.

When the SD card is inserted, the LCD screen will display the following.



SD card is detected and shows the Version and capacity. "xx" is the capacity.



Not supported card.



CAUTION!

Do not remove SD Card when data logging has been enabled (may corrupt files). Follow "STOP SD CARD" procedure (Section 4.10) before removing the SD Card.



ATTENTION!

Ne pas retirer la carte SD lorsque « data logging » a été activée (peut corrompre les fichiers). Suivez la procédure "STOP SD CARD" (article 4.10) avant de retirer la carte SD .

5.2 DATA LOGGING

5.2.1 General Information

NOTES:

1. Data logging records status of various operating parameters and events with respect to its internal Real Time Clock (RTC). It is, therefore, recommended that before starting data logging, the current date and time should be set (if not set already) using programming Parameter "TIME SETTING" ([Section 4.9](#))
2. In the factory default condition, data logging has been *enabled* at 1 sec recording interval [Parameter "DATALOG TIME" ([Section 4.8.2.10](#)) has been set to option "1 = 1 sec"]. *Hence, data logging will commence as soon as SD Card is inserted*
3. To *disable data logging*, parameter "DATALOG TIME" ([Section 4.8.2.10](#)) has to be set at option "0 = Disable"

As explained at Section 5.1 above, an SD Card (*FAT16 / FAT32, up to 16 GB*) may be used for Data Logging wherein up to 28 operating parameters including "Event" will be recorded on the SD Card automatically *as soon as the SD Card is inserted in the SD Card Slot of EVO-RC*. [Provided parameter "DATALOG TIME" ([Section 4.8.2.10](#)) has NOT been set to "0 = Disable"]. The 28 Data Fields are shown in Fig 5.1.

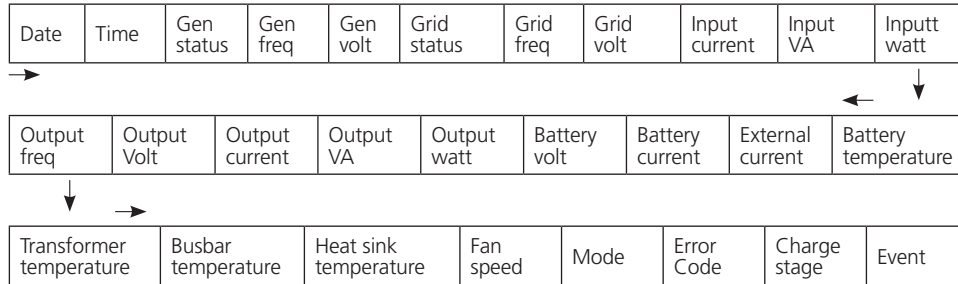

Fig 5.1 Data Logging Fields

The Data Fields shown in Fig 5.1 above can be recorded at one of the 6 time interval options shown below under programming parameter “DATALOG TIME” (See Section 4.8.2.10). Default time interval is 1 sec (Option “1=1 sec). Parameter “DATALOG TIME” is also used to disable data logging (Option 0=Disable). Interval / disabling options are shown below:

- 0 = Disable ; 1 = 1 sec (Default) ; 2 = 10 sec ; 3 = 30 sec ; 4 = 60 sec ; 5 = 5 min ; 6 = 10 min

NOTE

The last data field “Event” shown in Fig 5.1 above records an event as soon as it occurs

5.2.2 Operating Screens when SD Card is Inserted for Data Logging

Data logging will be carried out automatically as soon as the SD Card is inserted in the SD Card Slot of EVO-RC. [Provided parameter “DATALOG TIME” (Section 4.8.2.10) has NOT been set to “0 = Disable”].

Operating screens are shown below:

Data log function has been initiated and new file is being created. Do not remove the SD card when file creating is displayed.

Read error, the data log function/ update/ upload will stop.

Write error. The Data logging function will stop.

There is not enough space to create Data Log File Folder or to save file with saved programmed parameters.
NOTE: Once there is enough space to create a Data Log File Folder and subsequently, it runs out of capacity due to recording newer data, it will start to overwrite on older files.

5.2.3 Disabling Data Logging

In the factory default condition, data logging has been enabled at 1 sec recording interval [Parameter “DATALOG TIME” (Section 4.8.2.10) has been set to option “1 = 1 sec”]. Hence, data logging will commence as soon as SD Card is inserted.

To disable data logging, parameter “DATALOG TIME” (Section 4.8.2.10) has to be set at option “0 = Disable”.

5.3 DATA LOG FILES AND VIEWING DATA LOG FILES USING MICROSOFT EXCEL

The Data Log Files are written as Text Files (.txt) in the DATALOG Folder on the SD Card's Root Directory. Table 5.1 is an image of the DATALOG Folder showing example of the Data Log Files. The File Name Format is month/day/hour/minute.txt (MMDDhhmm.txt). Each file has 512 rows of records. (Each row has multiple data fields as shown in Fig 5.1/ Section 5.2.1) Each file size is 128kb.

TABLE 5.1 Example of Data Log Folder

07160900.txt	2019-07-16 9:00 AM	Text Document	31 KB
07160902.txt	2019-07-16 9:02 AM	Text Document	19 KB
07160911.txt	2019-07-16 9:11 AM	Text Document	72 KB
07160918.txt	2019-07-16 9:18 AM	Text Document	60 KB
07160928.txt	2019-07-16 9:28 AM	Text Document	75 KB
07160933.txt	2019-07-16 9:33 AM	Text Document	7 KB
07160935.txt	2019-07-16 9:35 AM	Text Document	10 KB
07160945.txt	2019-07-16 9:45 AM	Text Document	73 KB
07160948.txt	2019-07-16 9:48 AM	Text Document	22 KB
07160952.txt	2019-07-16 9:52 AM	Text Document	25 KB
07161002.txt	2019-07-16 10:02 ...	Text Document	74 KB
07161012.txt	2019-07-16 10:12 ...	Text Document	70 KB
07180735.txt	2019-07-18 8:04 AM	Text Document	20 KB

Table 5.2 below shows an example of one of the File's contents opened with a general purpose Text Reader. The First Row is Inverter Model, the Second Row is the title of columns, separate by ';' (See details of data fields at Fig 5.1/ Section 5.2.1). The 3rd Row onwards shows the status of various data fields at time interval equal to the programmed value of parameter "DATALOG TIME" (Section 4.8.2.10) [Default is 1 sec].

TABLE 5.2 Contents of Data Log File

Date	Time	Gen status	Gen freq	Gen volt	Grid status	Grid freq	Grid volt	Input current	Input VA	Input watt	Output freq	Output volt	Output current	Output VA	Output watt	Battery volt	Battery current	External current	Battery temp
2019-07-16	9:38:39	33340	0	0	0	59.94	240.45	2.71	326	325	59.94	241.44	0.53	65	51	58.778	0	0	25
2019-07-16	9:38:40	33340	0	0	0	59.94	240.82	2.77	333	333	59.94	240.86	0.89	107	102	58.778	0.3	0	25
2019-07-16	9:38:41	33340	0	0	0	59.94	240.62	2.72	327	327	60.09	240.56	0.71	85	78	58.778	0.7	0	25
2019-07-16	9:38:42	33340	0	0	0	59.94	240.11	2.72	326	326	60.09	241.5	0.91	110	102	58.778	0	0	25
2019-07-16	9:38:44	33340	0	0	0	59.94	240.54	2.73	328	328	59.94	241.13	0.83	100	94	58.778	0.7	0	25
2019-07-16	9:38:45	33340	0	0	0	59.94	240.49	2.71	326	326	60.09	240.56	0.79	95	88	58.778	0.1	0	25
2019-07-16	9:38:46	33340	0	0	0	59.94	240.16	2.76	331	331	59.94	240.53	0.8	97	90	58.778	1	0	25
2019-07-16	9:38:47	33340	0	0	0	59.94	240.42	2.72	328	327	59.94	240.2	0.65	78	71	58.778	0.1	0	25
2019-07-16	9:38:49	33340	0	0	0	60.09	239.79	2.75	330	330	59.94	240.69	0.96	116	111	58.778	0.9	0	25
2019-07-16	9:38:50	33340	0	0	0	59.94	239.6	2.7	323	323	60.09	240.74	0.61	74	60	58.778	0	0	25
2019-07-16	9:38:51	33340	0	0	0	59.94	240.22	2.77	333	332	59.94	240.26	0.98	117	113	58.778	0.8	0	25
2019-07-16	9:38:52	33340	0	0	0	59.94	240.32	2.73	328	328	59.94	240.21	0.65	78	71	58.778	0.3	0	25
2019-07-16	9:38:54	33340	0	0	0	60.09	239.76	2.74	328	328	59.94	240.96	0.98	118	113	58.778	0.2	0	25
2019-07-16	9:38:55	33340	0	0	0	59.94	240.09	2.71	325	325	59.94	240.91	0.67	81	72	58.778	0.4	0	25
2019-07-16	9:38:56	33340	0	0	0	59.94	240.47	2.73	329	329	59.94	240.47	0.91	110	105	58.778	0.2	0	25
2019-07-16	9:38:57	33340	0	0	0	59.94	240.28	2.75	330	330	59.94	240.29	0.72	87	79	58.778	0.9	0	25

Follow procedure given below to open Data Log Files in Excel:

- Start Microsoft Office Excel.
- Click File Menu Button / Microsoft Office Button on the left hand corner.
- Click "Open" from the Drop Down Menu.
- Navigate to the Directory where the Log Files downloaded from the SD Card are located.
- Click on "File Types" selection button at the bottom right corner (shows "All Excel Files" as default) and **select Text files from the Drop Down Menu.**
- All Text Files (.txt) will be displayed. The screen will look like Fig 5.1.

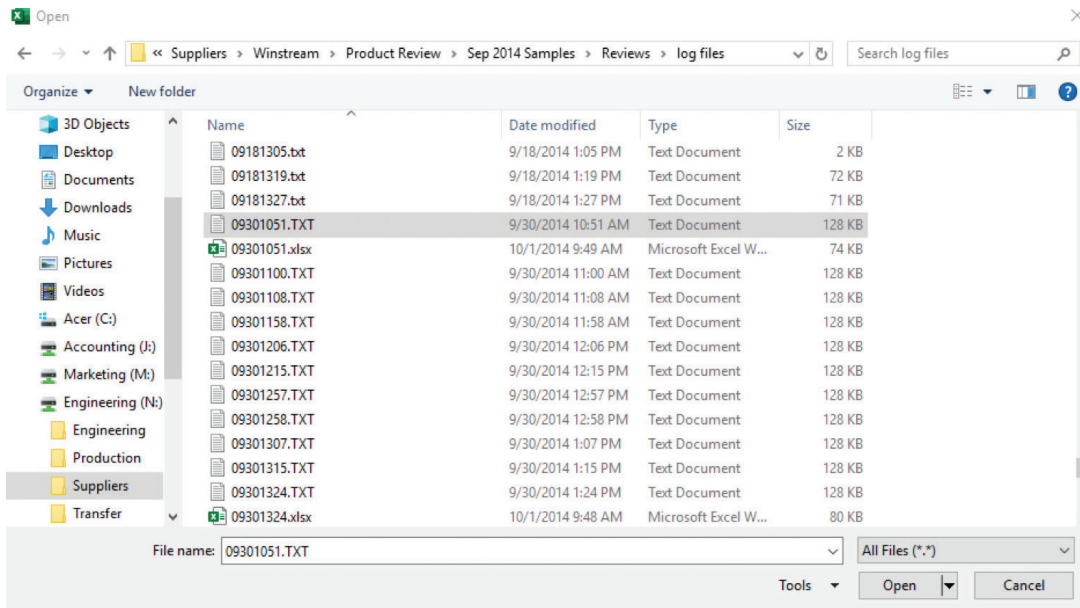

Fig 5.1 Screen Showing .txt Files

- Click "Open" Button (*Bottom right corner of Fig 5.1*).
- Text Import Wizard – Step 1 will be shown (*Fig 5.2*). Choose "Delimited" File Type".

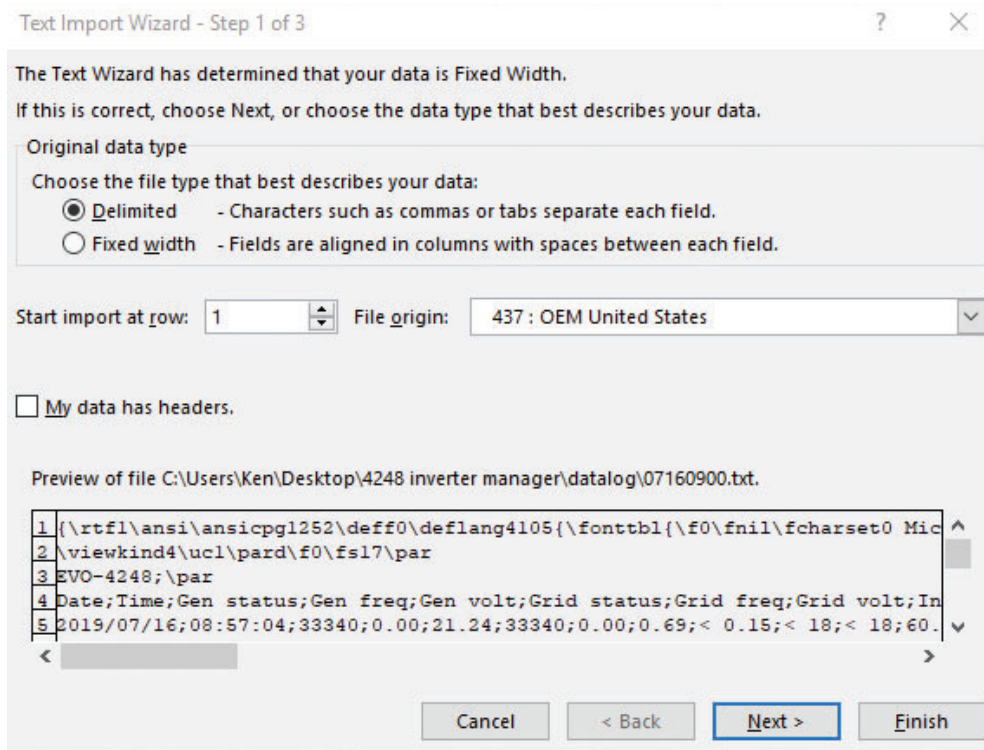

Fig 5.2 Screen Shot of Step 1 of "Text Import Wizard" in Excel

- Text Import Wizard – Step 2 will appear (*See Fig 5.3*). Choose "Semicolon" and click 'Finish' button.

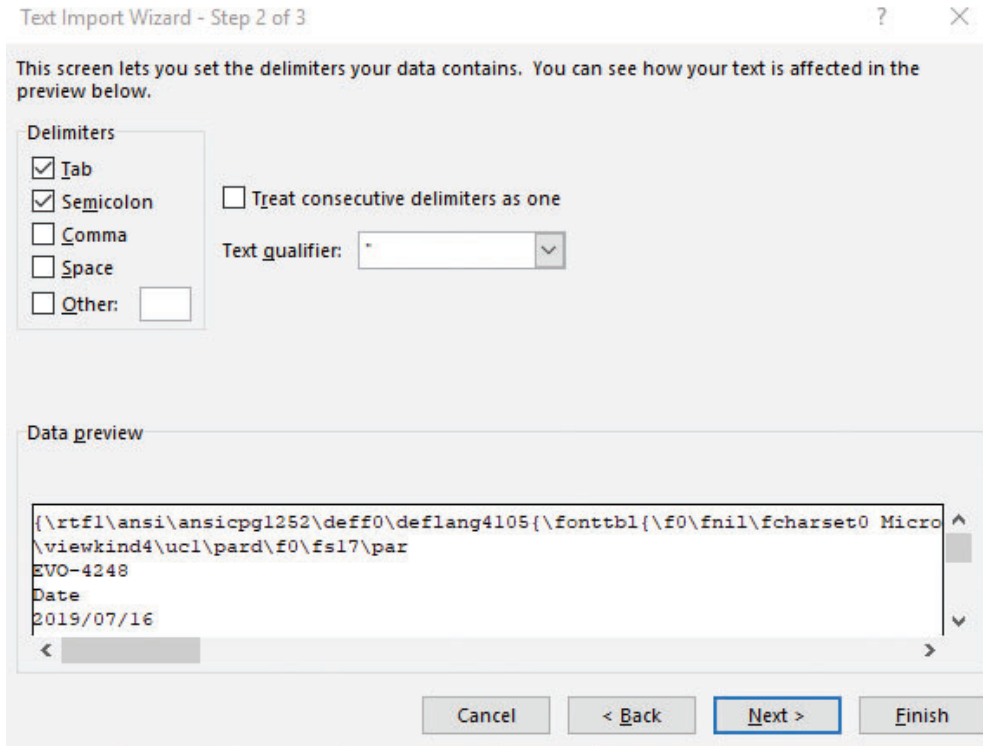

Fig 5.3 Screen Shot of Step 2 of "Text Import Wizard" in Excel

- Data as in Fig 5.4 will be displayed on your Worksheet, with the Log Data stored in Columns and Rows.

	A	B	C	D	E	F	G	H	I	J	K	L	M	N	O	P	Q	R	S	T	U	V	V
1	EVO-4248	par																					
2	Date	Time	Gen statu	Gen freq	Gen volt	Grid statu	Grid freq	Grid volt	Input curr	Input VA	Input wat	Output fri	Output vo	Output cu	Output V	Output wi	Battery vc	Battery cu	External c	Battery te	Transform	Bus bar	te Heat
3	2019-07-16	8:57:04	33340	0	21.24	33340	0	0.69 < 0.15	< 18	< 18	60	239.92	0.39	46	35	50.879	2.4	0	25	26.5	23.4		
4	2019-07-16	8:57:05	33340	0	21.22	33340	0	0.7 < 0.15	< 18	< 18	60	239.91	0.39	46	35	50.879	2.4	0	25	26.5	23.5		
5	2019-07-16	8:57:06	33340	0	21.26	33340	0	0.7 < 0.15	< 18	< 18	60	239.9	0.39	46	35	50.879	2.4	0	25	26.5	23.5		
6	2019-07-16	8:57:07	33340	0	21.25	33340	0	0.69 < 0.15	< 18	< 18	60	239.9	0.39	46	35	50.879	2.4	0	25	26.5	23.6		
7	2019-07-16	8:57:08	33340	0	21.26	33340	0	0.69 < 0.15	< 18	< 18	60	239.89	0.39	46	35	50.879	2.4	0	25	26.5	23.6		
8	2019-07-16	8:57:09	33340	0	21.24	33340	0	0.69 < 0.15	< 18	< 18	60	239.89	0.39	46	35	50.879	2.4	0	25	26.5	23.6		
9	2019-07-16	8:57:10	33340	0	21.24	33340	0	0.69 < 0.15	< 18	< 18	60	239.89	0.39	46	35	50.799	2.4	0	25	26	23.6		
10	2019-07-16	8:57:11	33340	0	21.24	33340	0	0.69 < 0.15	< 18	< 18	60	239.89	0.39	46	35	50.799	2.4	0	25	26	23.6		
11	2019-07-16	8:57:12	33340	0	21.25	33340	0	0.7 < 0.15	< 18	< 18	60	239.89	0.39	46	35	50.799	2.4	0	25	26	23.6		
12	2019-07-16	8:57:13	33340	0	21.24	33340	0	0.69 < 0.15	< 18	< 18	60	239.89	0.39	46	35	50.799	2.4	0	25	26	23.6		
13	2019-07-16	8:57:14	33340	0	21.23	33340	0	0.7 < 0.15	< 18	< 18	60	239.9	0.39	46	35	50.799	2.4	0	25	26	23.6		
14	2019-07-16	8:57:15	33340	0	21.26	33340	0	0.7 < 0.15	< 18	< 18	60	239.9	0.39	46	35	50.799	2.4	0	25	26	23.6		
15	2019-07-16	8:57:16	33340	0	21.25	33340	0	0.7 < 0.15	< 18	< 18	60	239.94	0.39	46	35	50.799	2.4	0	25	26	23.7		
16	2019-07-16	8:57:17	33340	0	21.25	33340	0	0.69 < 0.15	< 18	< 18	60	239.97	0.39	46	35	50.799	2.4	0	25	26.5	23.7		
17	2019-07-16	8:57:18	33340	0	21.23	33340	0	0.69 < 0.15	< 18	< 18	60	240.02	0.39	47	35	50.799	2.4	0	25	26.5	23.7		
18	2019-07-16	8:57:19	33340	0	21.24	33340	0	0.69 < 0.15	< 18	< 18	60	240.1	0.39	47	35	50.799	2.4	0	25	26.5	23.7		
19	2019-07-16	8:57:20	33340	0	21.24	33340	0	0.7 < 0.15	< 18	< 18	60	240.14	0.39	47	35	50.799	2.4	0	25	26.5	23.7		
20	2019-07-16	8:57:21	33340	0	21.26	33340	0	0.69 < 0.15	< 18	< 18	60	240.17	0.39	47	35	50.799	2.4	0	25	26.5	23.7		
21	2019-07-16	8:57:22	33340	0	21.26	33340	0	0.69 < 0.15	< 18	< 18	60	240.18	0.39	47	35	50.799	2.4	0	25	26.5	23.7		
22	2019-07-16	8:57:23	33340	0	21.25	33340	0	0.7 < 0.15	< 18	< 18	60	240.16	0.39	47	35	50.799	2.4	0	25	26.5	23.7		
23	2019-07-16	8:57:24	33340	0	21.28	33340	0	0.7 < 0.15	< 18	< 18	60	240.16	0.39	47	35	50.799	2.4	0	25	26.5	23.7		
24	2019-07-16	8:57:25	33340	0	21.27	33340	0	0.7 < 0.15	< 18	< 18	60	240.16	0.39	47	35	50.799	2.4	0	25	26.5	23.7		
25	2019-07-16	8:57:26	33340	0	21.27	33340	0	0.69 < 0.15	< 18	< 18	60	240.15	0.39	47	35	50.799	2.4	0	25	26.5	23.7		
26	2019-07-16	8:57:27	33340	0	21.27	33340	0	0.69 < 0.15	< 18	< 18	60	240.15	0.39	47	35	50.799	2.4	0	25	26.5	23.7		
27	2019-07-16	8:57:28	33340	0	21.26	33340	0	0.69 < 0.15	< 18	< 18	60	240.14	0.39	47	35	50.799	2.4	0	25	26	23.7		
28	2019-07-16	8:57:29	33340	0	21.26	33340	0	0.7 < 0.15	< 18	< 18	60	240.14	0.39	47	35	50.799	2.4	0	25	26	23.7		
29	2019-07-16	8:57:30	33340	0	21.25	33340	0	0.7 < 0.15	< 18	< 18	60	240.13	0.39	47	35	50.799	2.4	0	25	26	23.7		
30	2019-07-16	8:57:31	33340	0	21.28	33340	0	0.7 < 0.15	< 18	< 18	60	240.14	0.39	47	35	50.799	2.4	0	25	26	23.7		
31	2019-07-16	8:57:32	33340	0	21.28	33340	0	0.7 < 0.15	< 18	< 18	60	240.13	0.39	47	35	50.799	2.4	0	25	26	23.7		

Fig 5.4 Screen Shot and Data Log Work Sheet

5.4 SAVING / UPLOADING PROGRAMMED PARAMETERS

5.4.1 Saving Programmed Parameters

All the programmed parameters can be saved on an SD Card (*FAT 16 / FAT 32 Format, up to 16 GB capacity*). The parameters will be saved in File named "xxxx_yyy.cfg", where the first group of 4 digits xxx is the Model No. e.g. 2212 or 2224 or 3012 or 4024 and the second group of 3 digits YYY is the Revision No. for that model.

- For saving, first insert the SD Card in the SD Card Slot.
- Then, go to "Parameter Save" Screen (*See Section 4.8.2.11*). Steps are given below:

5.4.1.1 Programming Steps for Parameter "PARAMETER SAVE"

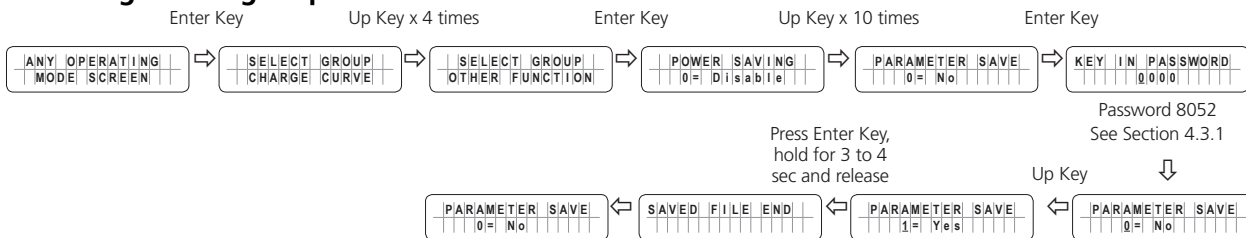

5.4.2 Uploading Saved Parameters

If there is a "xxxx_yyy.cfg" file in the SD card with stored programmed parameters, then on inserting the card, the Remote Control will ask to upload the Config File. Press Enter Button to confirm or Back Button to cancel.

UPLOAD CONF? YES=ENTER KEY Asks to confirm upload.

UPLOAD CONF? NO=BACK KEY Asks to cancel upload.

UPLOAD CONF 1% Configuration uploading.

SECTION 6 | Monitoring of Operation Using LED and Buzzer

Table 6.1 LED & BUZZER INDICATIONS FOR OPERATION MONITORING			
Status	Green LED "Status"	Red LED "Fault"	Buzzer (See Note 1)
Seen during Power-On Sequence Refer to Section 3.2.1	Blink 3 times & then turn off	OFF	OFF
Seen during Power-Off Sequence Refer to Section 3.2.2	ON	ON	OFF
Normal charging	Blink once in 1 sec interval	OFF	OFF
Equalization charging	Blink twice in 1 sec interval	OFF	OFF
Inverting	ON	OFF	Beep once in 3 sec interval
Low battery alarm	ON	Blink once in 1 sec interval	Beep once in 1 sec interval
Power saving	Blink once in 3 sec interval	OFF	OFF
Standby	Blink once in 5 sec interval	OFF	OFF
Fault	OFF	ON	ON

NOTE:

1. Buzzer is available only in EVO™ Inverter/Charger. There is no buzzer in Remote Control EVO-RC.

SECTION 7 | Fault Messages and Troubleshooting Guide



CAUTION!

The cause of the fault should be removed before the unit is restarted.



ATTENTION!

La cause de la panne doit être retiré avant un redémarrage de l'appareil.

TABLE 7.1 FAULT MESSAGES AND TROUBLESHOOTING GUIDE



NOTES: 1. Please see Table 6.1 for LED indications in EVO-RC and buzzer indications in EVO™ Inverter/Charger
 2. Buzzer is available only in EVO™ Inverter/Charger. There is no buzzer in Remote Control EVO-RC

Srl. No	Fault Message	Symptoms and Troubleshooting
1		<ul style="list-style-type: none"> EVO™ is in "FAULT MODE" because the battery voltage has dropped to the set lower threshold of "BATT LOW VOLTAGE" (Section 4.4.2.9) When the battery voltage drops to the threshold of parameter "BATT LOW VOLTAGE" (Section 4.4.2.9), activation of this fault protection is initiated. The Red LED marked "Fault" will flash once per second and the buzzer in the EVO will beep once per second. <i>The Inverter Section will continue to operate normally, and the Green LED marked "Status" will continue to be ON steady</i> (NOTE: <i>Fault message "Battery low voltage!" will not be displayed during this time</i>) If the battery voltage stays at or below the threshold of "BATT LOW VOLTAGE" (Section 4.4.2.9) for duration equal to parameter "LV DETECT TIME" (See Section 4.4.2.10), only the Inverter Section will be switched OFF and fault message "Battery low voltage!" will be displayed. The Red LED marked "Fault" will now change to steady ON, the Green LED marked "Status" will switch OFF and the buzzer in EVO will now beep steady. <i>The unit will get locked in this condition and will be required to be switched off as follows:</i> <ul style="list-style-type: none"> The unit will automatically switch off after expiry of time set by parameter "LV CUT OFF TIME" (See Section 4.4.2.11). [<i>LCD Display / LED / Buzzer will be OFF</i>], or In case the time set by parameter "LV CUT OFF TIME" (See Section 4.4.2.11) has not expired, switch off the unit manually (See Section 3.2.2) While in "Battery low voltage!" fault condition, if qualified AC input is made available before expiry of time set by parameter "LV CUT OFF TIME" (Section 4.4.2.11), the unit will automatically reset to "Charging Mode" <i>provided the battery voltage is >9V for EVO-2212/3012 or >18V for EVO-2224/4024</i> <ul style="list-style-type: none"> In case it is desired that the unit should not switch off due to "Battery low fault!" condition after expiry of time set by parameter "LV CUT OFF TIME" (Section 4.4.2.11) but should automatically reset to "Charging Mode" on availability of qualified AC input voltage with battery voltage > 9V for EVO-2212/3012 or >18V for EVO-2224/4024, time value of parameter "LV CUT OFF TIME" should be changed to 0 sec (Refer to Section 4.4.2.9.2) If the batteries are charged by external charger connected directly to the batteries or through the External Charger Input (3, 4 in Fig 2.1 in the attached Owner's Manual for EVO-2212/3012) and the battery voltage recovers to the set threshold of parameter "RESET VOLTAGE" (Section 4.4.2.7) before the expiry of time set by parameter "LV CUT OFF TIME" (Section 4.4.2.11) while in "Battery low voltage!" fault condition, the Inverter Section will restart and "Battery low voltage!" fault condition will be cleared.

SECTION 7 | Fault Messages and Troubleshooting Guide

Srl. No	Fault Message	Symptoms and Troubleshooting
2		<ul style="list-style-type: none"> • EVO™ is in FAULT MODE because the battery voltage has <i>dropped momentarily for 1 ms</i> to (i) 9V or below for EVO-2212/3012 or, (ii) 18V or below for EVO-2224/4024. • The Inverter Section will be switched OFF and message "Battery ultra low voltage!" will be displayed. Red LED marked "Fault" will be steady ON, Green LED marked "Status" will be switched OFF and the buzzer in EVO will beep steady. <u>The unit will get locked in this condition and will be required to be switched off as follows:</u> <ul style="list-style-type: none"> o The unit will automatically switch off after expiry of time set by parameter "LV CUT OFF TIME" (Section 4.4.2.11) [LCD display / LED / Buzzer will be OFF], or o In case the time set by parameter "LV CUT OFF TIME" (Section 4.4.2.11) has not expired, switch off the unit manually (See Section 3.2.2) • While in "Battery ultra low voltage!" fault condition, if qualified AC input is made available before expiry of time set by programming parameter "LV CUT OFF TIME" (Section 4.4.2.11), the unit will automatically reset to "Charging Mode" <u>provided the battery voltage is >9V for EVO-2212/3012 or >18V for EVO-2224/4024</u> <ul style="list-style-type: none"> o In case it is desired that the unit should NOT switch off due to "Battery ultra low voltage!" fault condition after expiry of time set by parameter "LV CUT OFF TIME" (Section 4.4.2.11) but should automatically reset to "Charging Mode" on availability of qualified AC input voltage with battery voltage >9V for EVO-2212/3012 or >18V for EVO-2224/4024, value of time set by parameter "LV CUT OFF TIME" should be changed to 0 sec (Refer to Section 4.4.2.9.2) • If the batteries are charged by external charger connected directly to the batteries or through the External Charger Input (3, 4 in Fig 2.1 in the attached EVO Owner's Manual) and the battery voltage recovers to the set threshold of parameter "RESET VOLTAGE" (Section 4.4.2.7) before the expiry of time set by parameter "LV CUT OFF TIME" (Section 4.4.2.11) while in "Battery ultra low voltage!" fault condition, the Inverter Section will restart and "Battery ultra low voltage!" fault condition will be cleared. <p>NOTE:</p> <p>Momentary low voltage threshold of 9V or lower for 1 ms for EVO-2212/3012 or 18V or lower for 1 ms for EVO-2224/4024 that triggers "Battery ultra low voltage!" fault is likely to be reached under the following operating conditions:</p> <ol style="list-style-type: none"> a) The threshold of parameter "BATT LOW VOLTAGE" (Section 4.4.2.9) has been set at very low Depth of Discharge – slightly above the lower programming limit of 9V for EVO-2212/3012 or slightly above 18V for EVO-2224/4024. When the battery voltage approaches this low level of discharge, <u>its internal resistance will be considerably higher</u> as compared its internal resistance at higher State of Charge b) AC load(s) being powered are of a type that draw very high starting surge current spikes. Examples of such types of loads are (i) Switched Mode Power Supply (SMPS) based devices like Battery Chargers / AC to DC Adapters/ AC to DC Drivers for LEDs (iii) Compact Fluorescent Lamps (CFL), (iv) Quartz Lamps, (v) Ceramic Heaters, (vi) Compressors, (vii) Motors and (viii) Laser Printers etc. c) When the above type of AC loads [See (b) above] are switched on in Inverting Mode, the high starting surge current spikes will produce considerably higher voltage drop across higher internal resistance of the battery because of operation at deeply discharged level approaching threshold set by parameter "BATT LOW VOLTAGE" threshold (Section 4.4.2.9). When this momentary drop is equal to 9V/18V or lower, the unit enters "Battery ultra low voltage!" fault condition

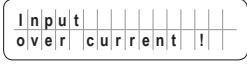
SECTION 7 | Fault Messages and Troubleshooting Guide

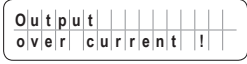
Srl. No	Fault Message	Symptoms and Troubleshooting
3		<p>EVO™ Inverter/Charger is in FAULT MODE because the battery voltage has risen to the set upper threshold of "BATT OVER VOLTAGE" (Section 4.4.2.6)</p> <p>(a) AC input is not available and EVO™ Inverter/Charger is operating in Inverting Mode:</p> <ul style="list-style-type: none"> • There will be no AC output because the Inverter Section will be switched OFF. The Green LED marked "Status" will be switched OFF and the Red LED marked "Fault" will be steady ON. The buzzer in EVO™ Inverter/Charger will beep steady • The fault will be cleared automatically when the battery voltage drops to 0.5V below the set upper threshold of "BATT OVER VOLT" (Section 4.4.2.6) <p>(b) AC input is available and EVO™ Inverter/Charger is operating in Charging Mode:</p> <ul style="list-style-type: none"> • There will be no AC output or charging because the Transfer Relay will be de-energized and PWM drive to the Inverter Section will be switched OFF. • The fault will be cleared automatically when the battery voltage drops to 0.5V below to the set upper threshold of "BATT OVER VOLT" (Section 4.4.2.6). The EVO™ Inverter/Charger will restart in Inverting Mode, synchronize with the AC input and then, the Transfer Relay will be energized to transfer to AC input at zero crossing. The unit will, thus, resume operation in "Charging Mode"
4		<p> INFO</p> <p>This FAULT MODE will be activated only when parameter "INPUT OC PROTECT" has been set to option "1=shutdown" (See Section 4.5.2.10 for additional details).</p> <p>EVO™ Inverter/Charger is in FAULT MODE because the input current being drawn from the AC input source (Input current = Charging Current + Pass Through Current to the load) is 1A more than the set threshold of " GRID MAX CURRENT" (Section 4.5.2.2) / "GEN MAX CURRENT" (Section 4.5.2.3) for 5 seconds (current is sampled every 33.3 μs).</p> <ul style="list-style-type: none"> • There will be no AC output because the Transfer Relay will be de-energized, charging will be stopped and PWM drive to the Inverter Section will be switched OFF. The Green LED marked "Status" will be switched OFF and the Red LED marked "Fault" will be steady ON. The buzzer in EVO™ Inverter/Charger will beep steady • EVO™ Inverter/Charger will be latched in OFF condition and will require manual reset by powering OFF, waiting for 1 minute and then powering ON again • The set threshold of " GRID MAX CURRENT" (Section 4.5.2.2) / "GEN MAX CURRENT" (Section 4.5.2.3) should match the breaker capacity of the AC input source / AC input Branch Circuit. If AC input current capacity cannot be increased, reduce the AC load / "BULK CURRENT" (Section 4.4.2.1) accordingly.
5		<p>EVO™ Inverter/Charger is in FAULT MODE because the instantaneous output current being drawn by the AC load in Inverting Mode is 330% of the rated value of the EVO™ Inverter/Charger for 2 samples (current is sampled every 33.3 μs).</p> <ul style="list-style-type: none"> • There will be no AC output because the Inverter Section will be switched OFF. The Green LED marked "Status" will be switched OFF and the Red LED marked "Fault" will be steady ON. The buzzer in EVO™ Inverter/Charger will beep steady • EVO™ Inverter/Charger will be latched in OFF condition and will require manual reset by powering OFF, waiting for 1 minute and then powering ON again • Ensure that the maximum instantaneous surge current of the load is not more than 300% of the rated current of the EVO™ Inverter/Charger for 1 millisecond

SECTION 7 | Fault Messages and Troubleshooting Guide

Srl. No	Fault Message	Symptoms and Troubleshooting
6	 	<p>EVO™ Inverter/Charger is in FAULT MODE because of overload conditions in Inverting Mode:</p> <ul style="list-style-type: none"> There will be no AC output because the Inverter Section will be switched OFF. The Green LED marked "Status" will be switched OFF and the Red LED marked "Fault" will be steady ON. The buzzer in EVO™ Inverter/Charger will beep steady EVO™ Inverter/Charger will be latched in OFF condition and will require manual reset by powering OFF, waiting for 1 minute and then powering ON again Ensure that overloading is limited to the specified limit <p>Output voltage is less than 96Vrms for 300 cycles (<i>5 seconds at 60Hz</i>)</p> <p>Output power is over the Power Boost Rating (110%) for 30 min</p> <p>Output power is over the Power Boost Rating (120%) for 5 minutes</p> <p>Output power is over the Power Boost Rating (140%) for 30 seconds</p> <p>Output power is over the Power Boost Rating (150%) for 5 seconds</p>
7		<p>EVO™ Inverter/Charger is in FAULT MODE because there is a short circuit on the output side in Inverter Mode. Short circuit protection is activated when (i) the output current is over 18.33 Arms for EVO-2212/2224, 25 Arms for EVO-3012 and 33.33 Arms for EVO-4024) and (ii) output voltage is less than 15 Vrms for 6 cycles (<i>0.1 second for 60 Hz</i>). (<i>NOTE: Current is sampled every 33.3 μs</i>)</p> <ul style="list-style-type: none"> There is no AC output because the Inverter Section has been switched OFF. The Green LED marked "Status" will be switched OFF and the Red LED marked "Fault" will be steady ON. The buzzer in EVO™ Inverter/Charger will beep steady EVO™ Inverter/Charger will be latched in OFF condition and will require manual reset by powering OFF, waiting for 1 minute and then powering ON again <p>NOTE: If there is short circuit condition in Charging Mode i.e. when AC input is available, short circuit condition on the output side will trip the AC input breaker. The load will be transferred to the Inverter Section and the Inverter Section will then see short circuit condition and will shut down as described above</p>
8		<p>EVO™ Inverter/Charger is in FAULT MODE because AC input from Grid / Generator has been connected to the AC Output terminals by mistake. 10VAC or above seen at the AC Output Terminals at the time of boot up of EVO™ Inverter/Charger will activate this protection</p> <ul style="list-style-type: none"> The Green LED marked "Status" will be switched OFF and the Red LED marked "Fault" will be steady ON. The buzzer in EVO™ Inverter/Charger will beep steady EVO™ Inverter/Charger will be latched in OFF condition and will require manual reset by powering OFF, waiting for 1 minute and then powering ON again <p>Check the connection. If there is 10V over at the output terminal, remove the connection.</p>
9		<p>EVO™ Inverter/Charger is in FAULT MODE because the main Bidirectional Transformer in the EVO™ Inverter/Charger has overheated to 150°C</p> <ul style="list-style-type: none"> The Green LED marked "Status" will be switched OFF and the Red LED marked "Fault" will be steady ON. The buzzer in EVO™ Inverter/Charger will beep steady If in Inverting Mode, Inverter Section will be switched OFF. If in Charging Mode, the Transfer Relay will be de-energized and the Inverter Section will be switched OFF. Check that the fans are working properly, there is no blockage of air suction and discharge vents, adequate cool replacement air is available and the ambient temperature is within the limits. Reduce the load / "BULK CURRENT" (<i>Section 4.4.2.1</i>) The fault will be cleared when the transformer has cooled down to 80°C

SECTION 7 | Fault Messages and Troubleshooting Guide

Srl. No	Fault Message	Symptoms and Troubleshooting
10	Heat sink overheat!	<p>EVO™ Inverter/Charger is in FAULT MODE because the internal heat sink in the EVO™ Inverter/Charger has overheated to 70°C</p> <ul style="list-style-type: none"> The Green LED marked "Status" will be switched OFF and the Red LED marked "Fault" will be steady ON. The buzzer in EVO™ Inverter/Charger will beep steady If in Inverting Mode, Inverter Section will be switched OFF. If in Charging Mode, the Transfer Relay will be de-energized and the Inverter Section will be switched OFF. Check that the fans are working properly, there is no blockage of air suction and discharge vents, adequate cool replacement air is available and the ambient temperature is within the limits. Reduce the load and "BULK CURRENT" (<i>Section 4.4.2.1</i>) The fault will be cleared when the heat sink has cooled down to 40°C
11	SD card unusable!	<ul style="list-style-type: none"> Data logging will not start. Check that the format is FAT16/FAT32. Check that the capacity is less than 16 GB. Re-format the card.
12	SD card read error!	<ul style="list-style-type: none"> Data logging stops. Remove and re-insert the card.
13	SD card write error!	<ul style="list-style-type: none"> Data logging stops. Remove and re-insert the card.
14	SD card full!	<ul style="list-style-type: none"> Move or delete files or re-format the card.
15	WRITE FAILURE!	<ul style="list-style-type: none"> The entered value of programmable parameter could not be written. Call Technical Support.
16	OUT OF RANGE!	<ul style="list-style-type: none"> The entered value of programmable parameter is out of the programmable range. Change parameter value to within the specified range.

8.1 SPECIFICATIONS

	MODEL NO.	EVO-RC
COMPATIBLE INVERTER/CHARGERS	MODEL NUMBERS	EVO-2212, EVO-3012, EVO-2224, EVO-4024 EVO-2212E, EVO-3012E, EVO-2224E, EVO-4024E
DISPLAY	LCD DISPLAY	2 Rows, 16 Character each, Alpha-Numeric LCD Display
	LED INDICATORS	Green (Status); Red (Fault / Alarm)
INPUT / OUTPUT CONNECTION	CABLE SET	RJ-45 Data Cable (Straight Wired); 10 Meters / 33 ft
ENVIRONMENT	OPERATING TEMPERATURE RANGE	-20°C to 60°C
DIMENSIONS	(W X H X D), MM	144 x 114 x 35.4
	(W X H X D), INCHES	5.6 x 4.5 x 1.4
WEIGHT	WEIGHT WITHOUT CABLE	0.2 kg / 0.4 lb
	WEIGHT WITH CABLES	0.5 kg / 1.2 lb

3 YEAR LIMITED WARRANTY

EVO-RC manufactured by Samlex America, Inc. (the "Warrantor") is warranted to be free from defects in workmanship and materials under normal use and service. The warranty period is 3 years for the United States and Canada, and is in effect from the date of purchase by the user (the "Purchaser").

Warranty outside of the United States and Canada is limited to 6 months. For a warranty claim, the Purchaser should contact the place of purchase to obtain a Return Authorization Number.

The defective part or unit should be returned at the Purchaser's expense to the authorized location. A written statement describing the nature of the defect, the date of purchase, the place of purchase, and the Purchaser's name, address and telephone number should also be included.

If upon the Warrantor's examination, the defect proves to be the result of defective material or workmanship, the equipment will be repaired or replaced at the Warrantor's option without charge, and returned to the Purchaser at the Warrantor's expense. (Contiguous US and Canada only) using a carrier of the warrantor's choice.

Warranty service shall be performed only by the Warrantor. Any attempt to remedy the defect by anyone other than the Warrantor shall render this warranty void. The warranty does not apply to units with a serial number that has been altered, removed or modified in any way.

There is no warranty for defects or damages to equipment or parts caused by:

- Installation, alternation, inspection or removal
- Normal wear and tear
- Abuse or misuse of the equipment including exposure to excessive heat, salt or fresh water spray, or water immersion
- Corrosion, fire, lightening, biological infestations or Acts of God
- Repairs attempted by anyone other than the Warrantor
- Improper use, contrary to operational instructions provided in product manual
- Shipping or transport

No other express warranty is hereby given and there are no warranties which extend beyond those described herein. This warranty is expressly in lieu of any other expressed or implied warranties, including any implied warranty of merchantability, fitness for the ordinary purposes for which such goods are used, or fitness for a particular purpose, or any other obligations on the part of the Warrantor or its employees and representatives.

There shall be no responsibility or liability whatsoever on the part of the Warrantor or its employees and representatives for injury to any persons, or damage to person or persons, or damage to property, or loss of income or profit, or any other consequential or resulting damage which may be claimed to have been incurred through the use or sale of the equipment, including any possible failure of malfunction of the equipment, or part thereof. The Warrantor assumes no liability for incidental or consequential damages of any kind.

Samlex America Inc. (the "Warrantor")

www.samlexamerica.com

Contact Information

Toll Free Numbers

Ph: 1 800 561 5885

Fax: 1 888 814 5210

Local Numbers

Ph: 604 525 3836

Fax: 604 525 5221

Website

www.samlexamerica.com

USA Shipping Warehouses

Kent, WA

Plymouth, MI

Canadian Shipping Warehouse

Delta, BC

Email purchase orders to
orders@samlexamerica.com

